

EN Instructions for Use for devices from serial number 20,000



# **VENTI*logic* LS**

# **VENTI*logic* plus**

Ventilation device



**LÖWENSTEIN**  
medical

# Contents

<b>1. Overview</b>	<b>4</b>	6.5 Clean the fan filter	72
1.1 Special markings on the device	12	6.6 Clean the accessories	72
1.2 Safety information in the instructions for use	22	6.7 Clean the SpO <sub>2</sub> module	72
<b>2. Description of device</b>	<b>23</b>	6.8 Disinfect, sterilize	72
2.1 Intended use	23	6.9 Change in patients	74
2.2 Owner/operator and user qualification	26	<b>7. Function check</b>	<b>75</b>
2.3 Description of function	26	7.1 Intervals	75
<b>3. Safety instructions</b>	<b>31</b>	7.2 Method	75
3.1 Safety information	31	7.3 Calibrate oxygen sensor (only valve ventilation)	79
<b>4. Set up device</b>	<b>39</b>	7.4 Energy supply	81
4.1 Set up and connect the device	39	<b>8. Troubleshooting</b>	<b>82</b>
4.2 Patient/ventilator interfaces	40	8.1 Faults	82
4.3 Connect valve ventilation	40	8.2 Alarms	84
4.4 Connect leakage ventilation	42	<b>9. Maintenance and safety checks</b>	<b>96</b>
4.5 Connect bacteria filter	44	9.1 Intervals	96
4.6 Therapy with oxygen supply	46	9.2 Batteries	97
4.7 Operation in the event of a power failure	49	9.3 Change filter	98
<b>5. Operation</b>	<b>50</b>	9.4 Change pressure-measurement tube (only leakage ventilation)	101
5.1 Controls	50	9.5 Safety check	101
5.2 Start up the device	52	9.6 Disposal	102
5.3 Handling batteries	54	<b>10. Scope of supply</b>	<b>104</b>
5.4 Activate/deactivate Auto switch-on (only leakage ventilation)	56	10.1 Standard scope of supply	104
5.5 Alarm list	57	10.2 Accessories and spare parts	109
5.6 Adjust brightness	58	<b>11. Technical data</b>	<b>110</b>
5.7 LIAM info	58	11.1 Therapy device	110
5.8 Overview	59	11.2 System resistances	114
5.9 Humidifier for patient circuits with patient valve	59	11.3 Bacteria filter WM 24148 and WM 27591	115
5.10 LIAM (insufflation)	60	11.4 Oxygen sensor	116
5.11 Select a program	62	11.5 SpO <sub>2</sub> module	116
5.12 After use	63	11.6 Analog box with therapy device	117
5.13 Travel with the therapy device	65	11.7 Pneumatic diagrams	118
<b>6. Hygiene treatment</b>	<b>68</b>	11.8 Safety distances	121
6.1 Intervals	68	11.9 Emission of electromagnetic interference	122
6.2 Clean leakage ventilation	69	11.10 Electromagnetic interference immunity	123
6.3 Clean the housing	71	11.11 Electromagnetic interference immunity for life-supporting medical electrical devices and medical electrical systems	125
6.4 Clean coarse dust filter/change fine filter	71		

11.12 Electromagnetic interference immunity  
for NON-LIFE-SUPPORTING medical  
electrical devices or medical electrical  
systems . . . . . 126

**12. Warranty . . . . . 127**  
**13. Declaration of conformity . . . . . 127**

# 1. Overview

## Therapy device, general

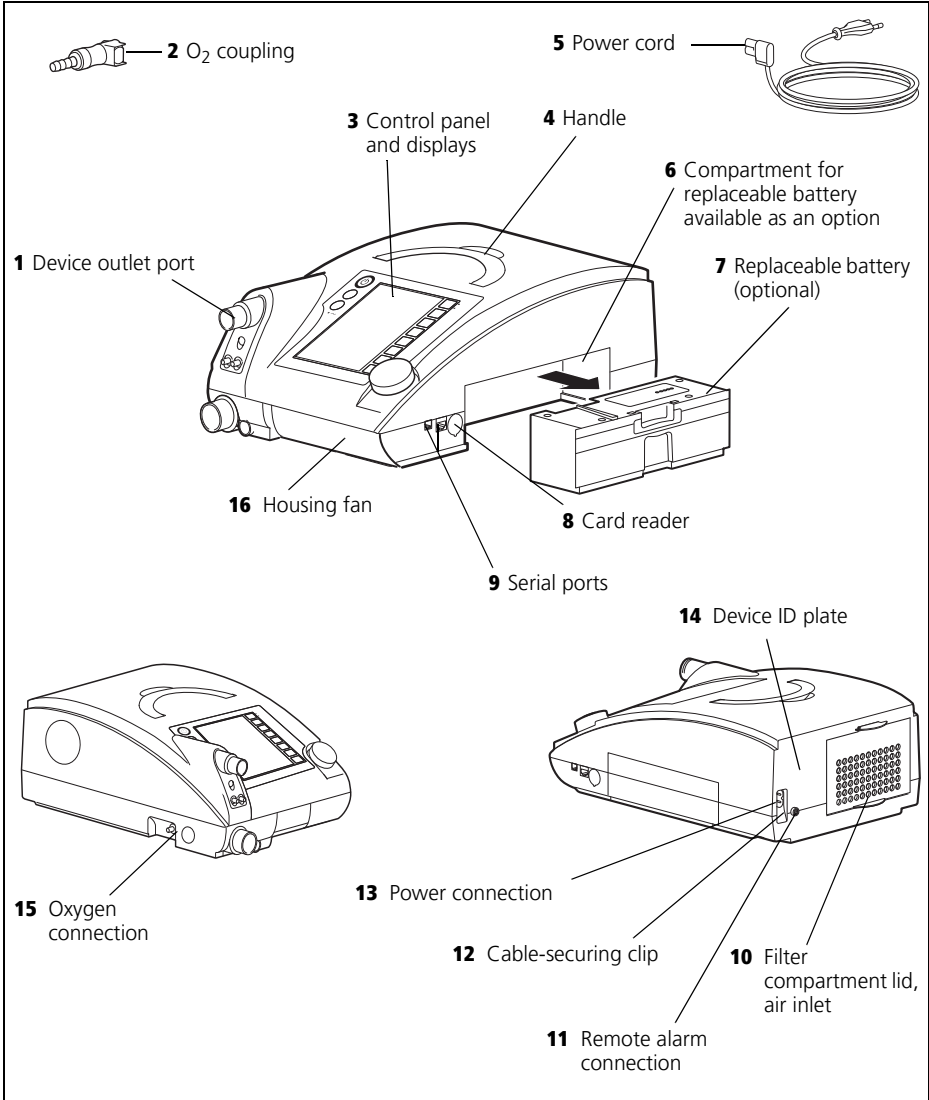

## Key

### 1 Device outlet port

The respiratory air flows to the patient from here via the patient circuit and the patient/ventilator interface.

### 2 O<sub>2</sub> coupling

Serves as an adapter for connecting the oxygen source to the therapy device.

### 3 Control panel and displays

For controlling and monitoring the therapy device and connected accessories.

### 4 Handle

For transporting the device.

### 5 Power cord

For connecting the therapy device to the power supply.

### 6 Compartment for replaceable battery available as an option

For connecting a replaceable battery, available as an option. If you are not using a replaceable battery, the compartment is sealed with a panel.

### 7 Replaceable battery (optional)

Available as an accessory. For mobile power supply to the therapy device.

### 8 Card reader

Slot for a memory card. Therapy data are stored on the memory card which the doctor can call up.

### 9 Serial ports

For connecting devices for displaying and evaluating therapy data.

### 10 Filter compartment lid, air inlet

For covering and securely positioning the coarse dust and fine filters.

### 11 Remote alarm connection

For connecting the hospital's internal nurse call system or the VENTI*remote alarm* remote alarm case for use outside the hospital.

### 12 Cable-securing clip

Prevents the device being disconnected from the power supply inadvertently.

### 13 Power connection

This is where the power cord is connected to the device.

### 14 Device ID plate

Provides information about the device, such as serial number and year of manufacture, for example.

### 15 Oxygen connection

For connecting the oxygen supply if oxygen supply has been prescribed.

### 16 Housing fan

Protects the device from overheating.

## Therapy device with leakage ventilation

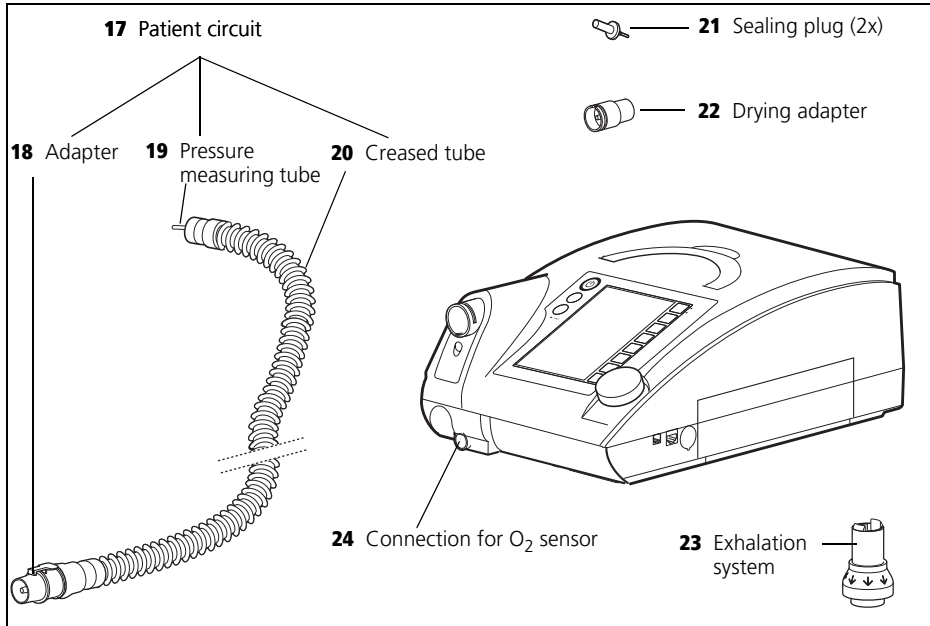

### Key

#### 17 Patient circuit

The air flows to the patient/ventilator interface through the patient circuit. The patient circuit consists of creased hose, pressure measuring tube and adapter.

#### 18 Adapter

For connecting the patient circuit to the device outlet port.

#### 19 Pressure measuring tube

For measuring therapy pressure.

#### 20 Creased tube

Delivers respiratory air to the patient.

#### 21 Sealing plug (2x)

For sealing off the pressure measuring tube during cleaning (only with leakage ventilation).

#### 22 Drying adapter

Required to dry the patient circuit with the aid of the therapy device and for the function check.

#### 23 Exhalation system

Carbon dioxide-enriched exhaled air escapes here during therapy.

#### 24 Connection for O<sub>2</sub> sensor

For connecting an oxygen sensor which can be used to measure oxygen concentration in respiratory air.

## Therapy device, single patient circuit with patient valve

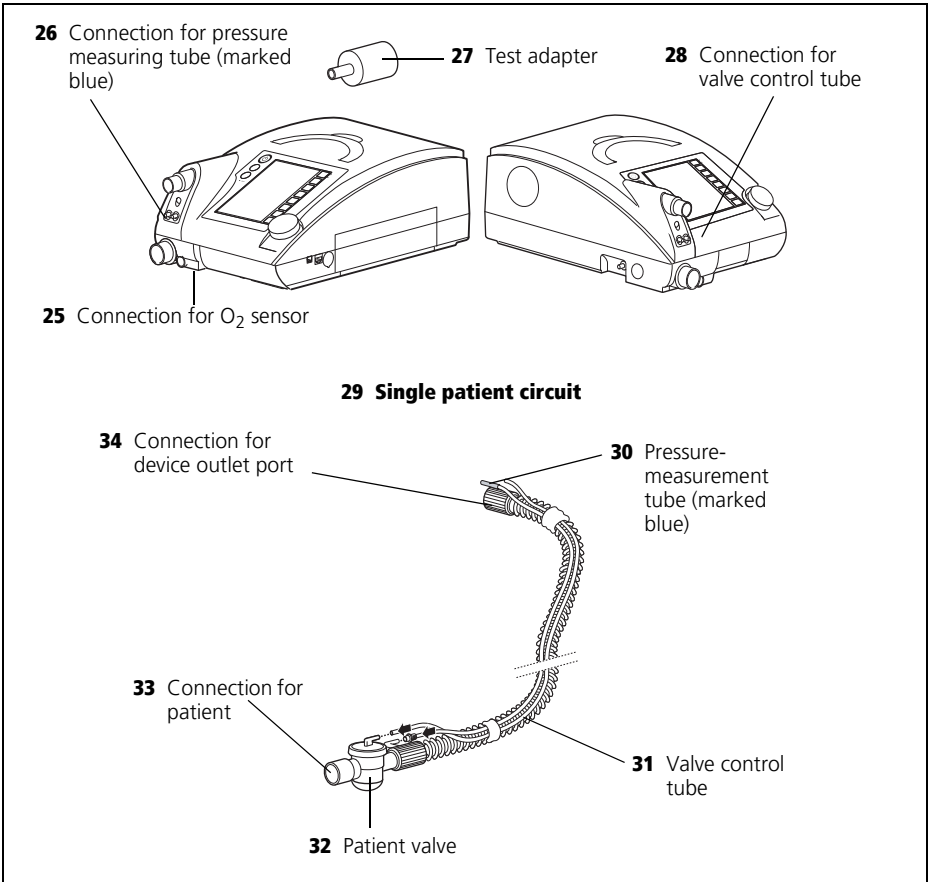

### Key

#### 25 Connection for O<sub>2</sub> sensor

For connecting an oxygen sensor which can be used to measure oxygen concentration in respiratory air (only with patient circuits with a patient valve).

#### 26 Connection for pressure measuring tube (marked blue)

For connecting the pressure measuring tube to the device.

#### 27 Test adapter

Required for the function check of the therapy device.

#### 28 Connection for valve control tube

For connecting the valve control tube to the device.

#### 29 Single patient circuit

Delivers respiratory air to the patient.

**30 Pressure-measurement tube (marked blue)**

For measuring therapy pressure.

**31 Valve control tube**

For controlling (opening and closing) the patient valve.

**32 Patient valve**

For routing the patient's exhaled air out of the patient circuit.

**33 Connection for patient**

This is where the patient/ventilator interface is connected.

**34 Connection for device outlet port**

This is where the patient circuit is connected to the device outlet port of the therapy device.



# Therapy device, double patient circuit with patient valve (VENTIlogic LS only)

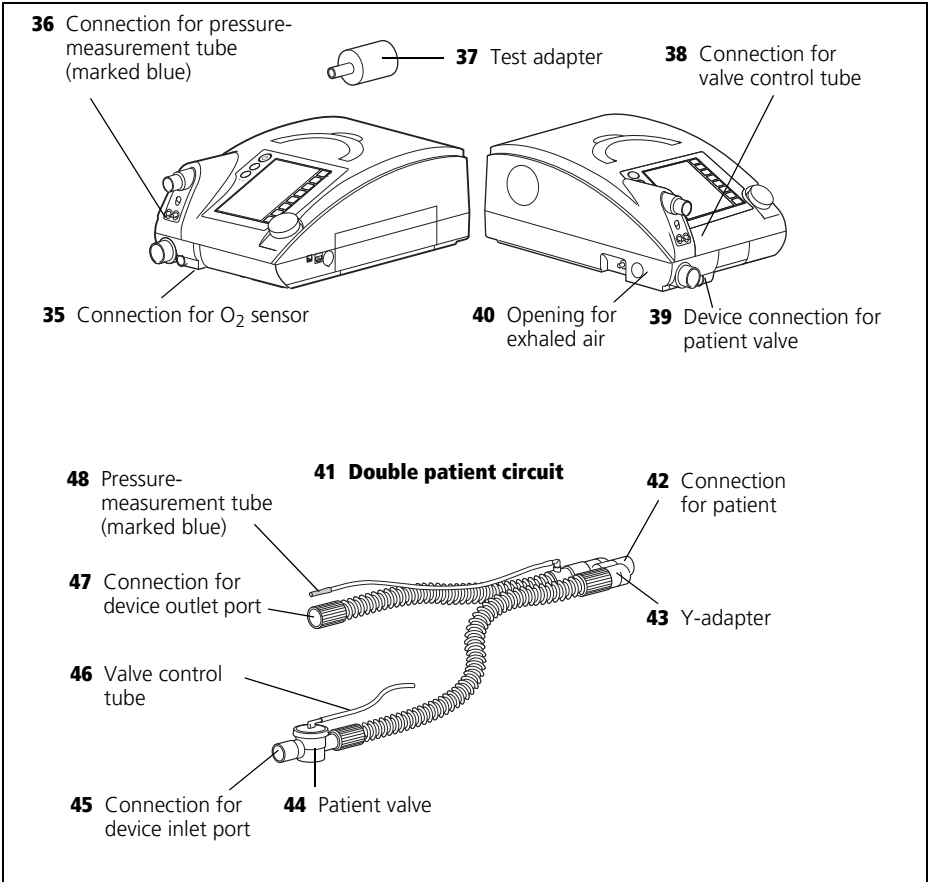

## 35 Connection for O<sub>2</sub> sensor

For connecting an oxygen sensor which can be used to measure oxygen concentration in respiratory air (only with patient circuits with a patient valve).

## 36 Connection for pressure-measurement tube (marked blue)

For connecting the pressure measuring tube to the device.

## 37 Test adapter

Required for the function check of the therapy device.

## 38 Connection for valve control tube

For connecting the valve control tube to the device.

## 39 Device connection for patient valve

For connecting the patient valve to the device inlet port of the therapy device.

#### **40 Opening for exhaled air**

This is where the patient's exhaled air is routed out of the device.

#### **41 Double patient circuit**

Delivers respiratory air to the patient and from the patient back to the device.

#### **42 Connection for patient**

This is where the patient/ventilator interface is connected.

#### **43 Y-adapter**

When the double patient circuit is used, this brings the inspiration and exhalation tubes together and serves as an adapter for connection to the patient/ventilator interface.

#### **44 Patient valve**

For routing the patient's exhaled air out of the patient circuit.

#### **45 Connection for device inlet port**

This is where the patient circuit is connected to the device outlet port of the therapy device.

#### **46 Valve control tube**

For controlling (opening and closing) the patient valve.

#### **47 Connection for device outlet port**

This is where the patient circuit is connected to the device inlet port for the patient valve (only with double patient circuit with patient valve).

#### **48 Pressure-measurement tube (marked blue)**

For measuring therapy pressure.

## Accessories

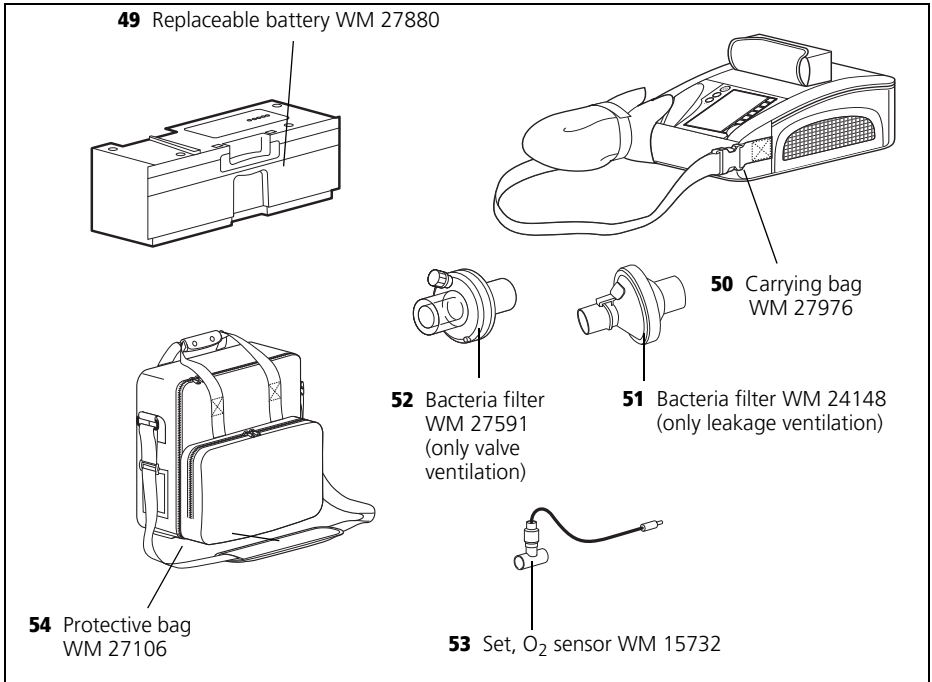

## Key

### **49 Replaceable battery WM 27880**

Available as an accessory, for mobile power supply to the therapy device.

### **50 Carrying bag WM 27976**

For mobile use of the therapy device. The enclosed straps are for attaching the carrying bag to a wheelchair.

### **51 Bacteria filter WM 24148 (only leakage ventilation) and 52 Bacteria filter WM 27591 (only valve ventilation)**

For protecting the device from contamination, in particular when the device is used by several patients (patient change).

### **53 Set, O<sub>2</sub> sensor WM 15732**

For measuring oxygen concentration at the device outlet port.

### **54 Protective bag WM 27106**



For protecting the therapy device during transport.



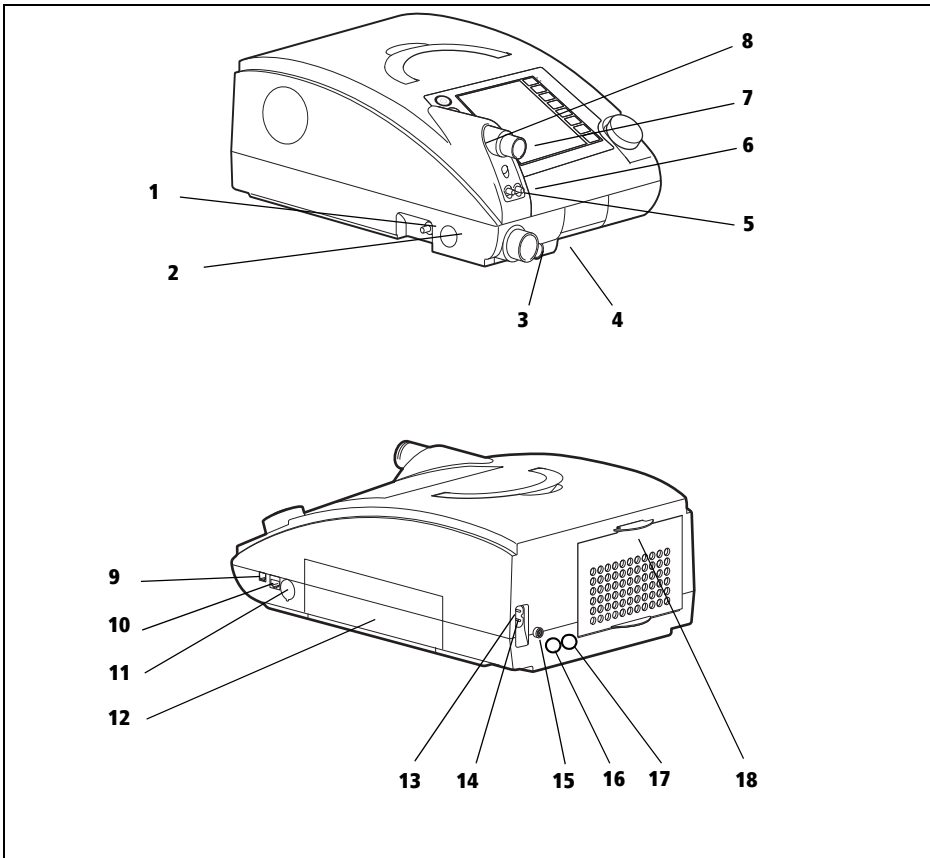



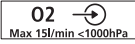





You can order accessories separately if required. A current list of accessories and replacement parts can be ordered on the internet site of the manufacturer or through your authorized specialist dealer.









# 1.1 Special markings on the device



## Left-hand side

<p>1</p>  <p>Max 15l/min &lt;1000hPa</p>	<p>Oxygen connection: maximum supply rate: 15 l/min at &lt; 1000 hPa</p>
<p>2</p> 	<p><b>VENTIllogic LS:</b> Opening for exhaled air when operated with double patient circuit with patient valve; do not seal opening or block in any other way.</p> <p><b>VENTIllogic plus:</b> Opening is not used with VENTIllogic plus.</p>

<b>Front</b>	
<b>3</b>	 <p><b>VENTIlogic LS:</b> Connection for patient's exhaled air with double patient circuit with patient valve. <b>VENTIlogic plus:</b> Opening is not used with VENTIlogic plus.</p>
<b>4</b>	 <p>Jack: electrical connection for oxygen sensor; max. 100 mV DC</p>
<b>5</b>	 <p>Connection: pressure measuring tube (marked blue). Therapy pressure 0 - 50 hPa (only for patient circuit with patient valve)</p>
<b>6</b>	 <p>Connection: control tube for patient valve 0 - 50 hPa (only patient circuit with patient valve)</p>
<b>7</b>	 <p>Device outlet port: outlet for exhaled air at 0 - 45 hPa with patient circuits with patient valve, 0 - 40 hPa with leakage ventilation</p>
<b>8</b>	 <p>Device outlet port: only patient circuits with a diameter of <math>\varnothing</math> 15 mm - 22 mm are permitted.</p>
<b>Right-hand side</b>	
<b>9</b>	 <p>Connection for optional attachments, e.g. Analog box D/A; max. current delivery at 5 V: 50 mA</p>
<b>10</b>	 <p>Connection for specialist staff to set therapy parameters using VENTIviews; max. current delivery at 12 V: 50 mA</p>
<b>11</b>	 <p>SD card slot</p>
<b>12</b>	 <p>Replaceable battery</p>
<b>Rear</b>	
<b>13</b>	 <p>Connector for power supply input 100-230 V AC; 50/60 Hz</p>
<b>14</b>	 <p>Follow instructions for use</p>
<b>15</b>	 <p>Connection for remote alarm: connection for nurse call system and VENTIremote alarm remote alarm case. Breaking capacity: 60 V DC/2 A; 42 V AC/2 A</p>

16		Service label: indicates when the next service is due
17		Safety check label: (in Germany only) marks when the next safety check as per §6 of the German law relating to users of medical devices is required
18		Device inlet port: inlet port for ambient air at room temperature
<b>Device ID plate (rear)</b>		
		Follow Instructions for Use
		Type BF application part
		Protection class II, protective insulation
		Manufacturer
		Do not dispose of device in domestic waste!
<b>SN</b>		Serial number
100-230 V ~, 50-60 Hz		Electrical rating
<b>CE 0197</b>		CE 0197 symbol: Confirms that the product conforms to the applicable European directives
		Protect device from wet

## Control panel

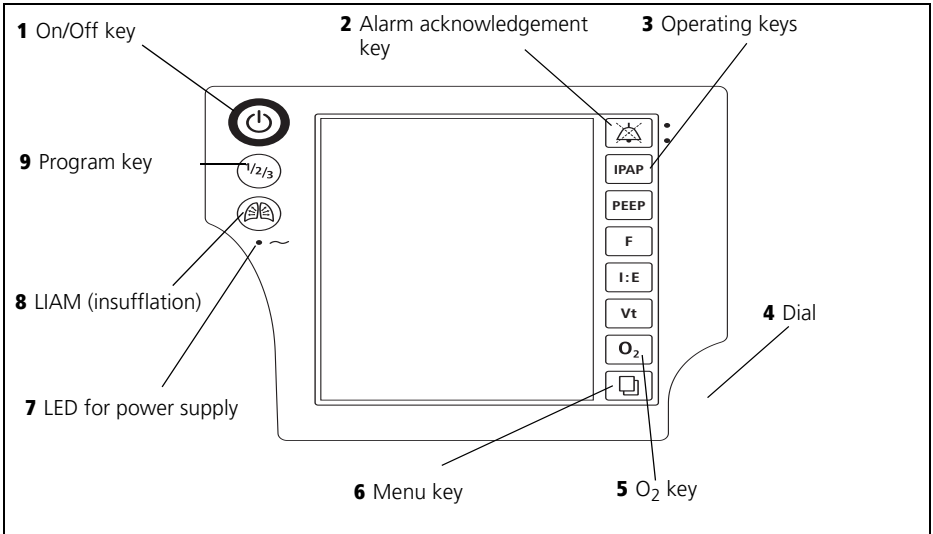

## Key

### 1 On/Off key

For switching the therapy device on and off.

### 2 Alarm acknowledgement key

The alarm acknowledgement key is for the temporary muting of alarms. The LED displays alarms visually.

### 3 Operating keys

For quick-setting by a doctor; deactivated in patient mode.

### 4 Dial

Central control of the therapy device, for navigating in the menu.

### 5 O<sub>2</sub> key

Starts calibration of the O<sub>2</sub> sensor. Has other functions in the Clinical menu.

### 6 Menu key

For switching from the default display to the menu and vice versa.

### 7 LED for power supply

The green LED comes on when there is a power supply.

### 8 LIAM (insufflation)

For triggering a coughing episode or ventilating a sigh.

### 9 Program key

For switching to one of the three pre-configured programs manually.

## Default display during therapy

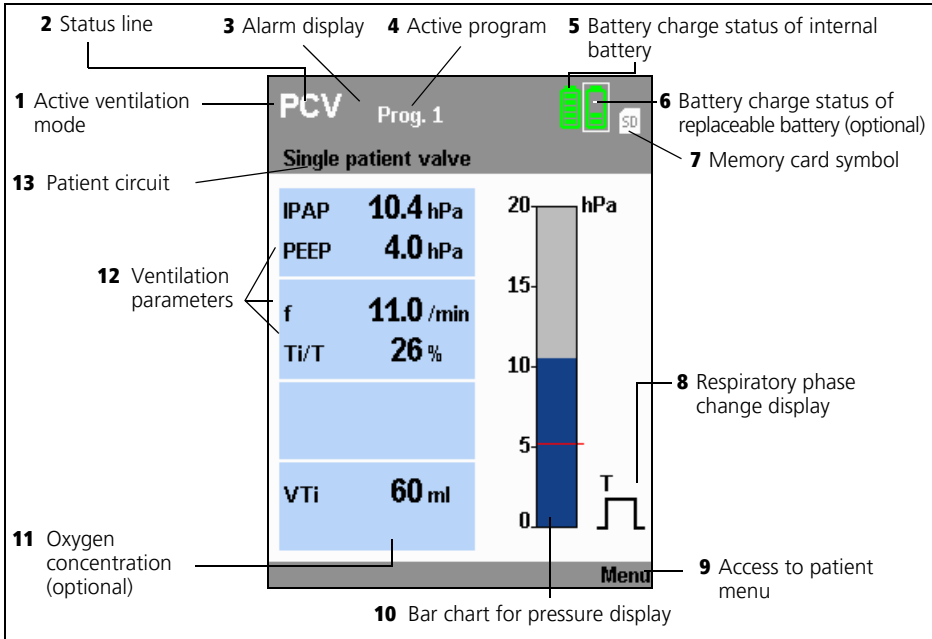

## Key

### 1 Active ventilation mode

The active ventilation mode is displayed at this point in the status line.

### 2 Status line

This is where device status information (such as alarm state display, filter change or servicing due) is displayed.

### 3 Alarm display

If an alarm has been muted, it is then shown in the status line for 120 seconds.

### 4 Active program

Indicates the ventilation program currently active.

### 5 Battery charge status of internal battery

Displays the charge status of the internal battery. When the battery is charging, the segments are shown consecutively.

### 6 Battery charge status of replaceable battery (optional)

Displays the charge status of the replaceable battery available as an option. If the battery is being charged, the segments are shown in succession.

### 7 Memory card symbol

Appears if a memory card is present and there is data saved on the memory card.

### 8 Respiratory phase change display

Indicates whether the current respiratory phase change is spontaneous or mandatory (spontaneous: S, mandatory: T); the display changes from left (inspiration) to right (expiration) depending on respiratory phase; mandatory expiration is shown here.

Also indicates whether the trigger for inspiration is blocked due to an activated trigger lockout time at the start of expiration (**IB**).



## **9 Access to patient menu**

Use the key adjacent to this menu item to switch to the patient menu and back to the default display.

## **10 Bar chart for pressure display**

For the graphical display of therapy pressure.

## **11 Oxygen concentration (optional)**

Gives oxygen concentration in respiratory air in percent.















## **12 Ventilation parameters**







The relevant current ventilation parameters are displayed depending on the active mode.

## **13 Patient circuit**

The relevant text to suit the set patient circuit appears in the status line.

## Symbols used in the display

Symbol	Significance
<b>Status line:</b>	
	Filter change required
	Servicing required
	Acoustic signal of alarms muted for 120 seconds
	All physiological alarms deactivated (exception for VENTIlogic LS: In VCV and aVCV modes, the <b>Pressure high</b> and <b>Pressure low</b> alarms cannot be deactivated)
	Blower off (standby mode)
	Battery display green (2-5 segments): battery capacity over 25 %
	Battery display orange: battery capacity below 25 %
	Battery display red: battery capacity below 10 %
	Segments are displayed in succession: device operated by power supply, battery charging
	Battery not present
	Battery not ready for use: – battery defective or – battery too cold or – battery too hot
	Battery not recognized as a genuine battery. Replace battery.
	Device in internal battery mode.
	Measured values are written to the SD card





Symbol	Significance
	SD card is write-protected or defective. No data can be recorded.
<b>Alarm window:</b>	
	Low-priority alarm triggered
	Medium-priority alarm triggered
	High-priority alarm triggered
<b>Main window:</b>	
	Plateau signal switched on
	Plateau signal switched off

## Abbreviations used in the display

Symbol	Significance
<b>Status line:</b>	
<b>S</b>	S mode active
<b>ST</b>	ST mode active
<b>T</b>	T mode active
<b>CPAP</b>	CPAP mode active
<b>PCV</b>	PCV mode active
<b>PSV</b>	PSV mode active
<b>aPCV</b>	aPCV mode active
<b>VCV</b>	VCV mode active (VENTI <i>logic</i> LS only)
<b>aVCV</b>	aVCV mode active (VENTI <i>logic</i> LS only)
<b>SIMV</b>	SIMV mode active
<b>MPVp</b>	MPVp mode active
<b>MPVv</b>	MPVv mode active
<b>+V</b>	Volume compensation activated (after mode: e.g. <b>PCV<sup>+V</sup></b> )
<b>+A</b>	AirTrapControl activated (after mode: e.g. <b>ST <sup>+A</sup></b> )
<b>+LIAM</b>	LIAM enabled: displayed under the current mode, e.g.: <b>PCV +LIAM</b>
<b>LIAM</b>	LIAM (Lung Insufflation Assist Maneuver) active
<b>Prog.</b>	Active ventilation program
<b>Main window (Monitor):</b>	
<b>IPAP</b>	Inspiration pressure
<b>EPAP / PEEP</b>	Exhalation pressure
<b>P<sub>SIMV</sub></b>	Specifies the inspiration pressure level of the back-up ventilation (SIMV mode only)
<b>hPa</b>	Pressure given in hectopascals; 1.01973 hPa corresponds to 1 cm H <sub>2</sub> O.
<b>f</b>	Respiratory frequency
<b>S</b>	Respiratory phase switch triggered - spontaneous

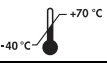
Symbol	Significance
<b>T</b>	Respiratory phase switch triggered - mandatory
<b>B</b>	Trigger for inspiration blocked during expiration
<b>Ti/T</b>	Proportion of inspiration time in a respiratory cycle
<b>VT</b>	Tidal volume
<b>VTi</b>	Tidal volume on inspiration
<b>VTe</b>	Tidal volume on exhalation
<b>Ti</b>	Inspiration time
<b>Te</b>	Exhalation time
<b>O<sub>2</sub> (21%)</b>	Mean oxygen concentration Shown in brackets: measuring cell not calibrated, perform oxygen calibration
<b>SpO<sub>2</sub> (%)</b>	Oxygen saturation
<b>bpm</b>	Pulse beats per minute
<b>Tapnoe</b>	Time since patient's last spontaneous breath (only in MPVv and MPVp modes)

## Markings on the packaging

Symbol	Significance
<b>Therapy device:</b>	
<b>SN</b>	Serial number of device
	Permitted temperature for storage: -40 °C to +70 °C
	Permitted humidity for storage: max. 95 % relative humidity
	Protect pack from wet
	Do not tip over or drop pack

## 1.2 Safety information in the instructions for use

---

Safety information in these instructions for use is marked as follows:



**Warning!**

Warns of risk of injury and potential material damage.

**Caution!**

Warns of material damage and potentially false therapy results.

**Note:**

Contains useful tips.

# 2. Description of device

---

## 2.1 Intended use

---

### 2.1.1 VENTI*logic* LS

VENTI*logic* LS is used for invasive and non-invasive life-support ventilation in accordance with ISO 10651-2 and for non-life-support mouthpiece ventilation in MPV mode.

The device can be used in both static or mobile operation, both at home and in appropriate hospital departments.

**Note**

VENTI*logic* LS is not a ventilator for intensive care purposes in accordance with ISO 80601-2-12.

The device can be used for weaning off invasive ventilation and converting to mask ventilation. It is used on patients with medium to severe acute and chronic global respiratory insufficiency with a tidal volume of at least 50 ml and a body weight of at least 5 kg.

### 2.1.2 VENTI*logic* plus

VENTI*logic* plus is used for invasive and non-invasive non-life-support ventilation in accordance with ISO 10651-6.

The device can be used in both static or mobile operation, both at home and in appropriate hospital departments.

**Note**

VENTI*logic* plus is not a ventilator for intensive care purposes in accordance with ISO 80601-2-12.

The device can be used for weaning off invasive ventilation and converting to mask ventilation. It is used on patients with medium to severe acute and chronic global respiratory insufficiency with a tidal volume of at least 50 ml and a body weight of at least 5 kg.

### 2.1.3 Indication

- obstructive respiratory disorders, such as COPD
- restrictive respiratory disorders such as scolioses, deformities of the thorax
- neurological, muscular and neuromuscular disorders, such as muscular dystrophies, pareses of the diaphragm etc.
- central respiratory regulation disorders
- hypoventilation syndrome associated with obesity

### 2.1.4 Contraindications

The therapy device should not be used or should be used only with particular caution in the case of the following diseases. In the individual case, the decision about therapy is the responsibility of the doctor supervising treatment.

- Cardiac decompensation
- Severe cardiac arrhythmia
- Severe hypotension, particularly in combination with intravascular volume depletion
- Severe epistaxis
- High risk of barotrauma
- Pneumothorax or pneumomediastinum
- Pneumoencephalus
- Skull trauma
- Status following brain surgery and following surgical intervention at the pituitary gland or the middle/inner ear
- Acute sinusitis, otitis media or perforated eardrum
- Dehydration

### 2.1.5 Non-invasive ventilation (NIV) with VENTI/logic LS and VENTI/logic plus

The following indications and contraindications furthermore apply specifically to NON-INVASIVE ventilation:

Typical indications for NIV:

- Chronic diseases of the respiratory tract
- Restrictive ventilation disorders



- Obesity hypoventilation syndrome
- Neuromuscular diseases

Absolute contraindications for NIV:

- No spontaneous breathing, gasping for breath
- Permanent or functional displacement of the airways
- Gastrointestinal hemorrhage or ileus

Relative contraindications for NIV:

- Coma
- Massive agitation
- Massive secretion despite bronchoscopy
- Severe hypoxemia or acidosis (pH < 7.1)
- Hemodynamic instability (cardiogenic shock, myocardial infarction)
- Anatomical and/or subjective incompatibility with interface
- Status following surgery on the upper gastrointestinal tract
- Severe swallowing disorders (bulbar disorders) with the risk of aspirations.

Dangerous situations involving this therapy device have not yet been observed.

## 2.1.6 Side effects

When using the therapy device, the following undesired side effects may occur in short-term or long-term use:

- pressure points on the face from the breathing mask and the forehead cushion
- reddening of facial skin
- blocked nose
- dry nose
- dry mouth in the morning
- feeling of pressure in the sinuses
- irritated mucous membrane in the eyes
- gastrointestinal insufflation of air ("bloating")
- nosebleeds
- muscular atrophy in the case of long-term ventilation

## 2.2 Owner/operator and user qualification

---

As an owner/operator or user, you must be familiar with the operation of this medical device. Observe the legal requirements for operation and use (in Germany, the regulations governing owner/operators of medical devices apply in particular). Basic recommendation: Get a person authorized by the manufacturer to provide you with proper instruction about the handling, use and operation of this medical device.

## 2.3 Description of function

---

### 2.3.1 Providing the therapy pressure

An electronically-controlled blower draws in ambient air through a filter and delivers it to the device outlet port. From here, air flows through the patient circuit and the patient/ventilator interface to the patient.

Sensors detect the pressure at the patient/ventilator interface and in the patient circuit, as well as the respiratory phase change. The blower accordingly provides the respiratory volume and the IPAP and EPAP / PEEP pressures prescribed by the doctor.

### 2.3.2 Display and operation

The display shows the therapy mode and, as a function of the mode, the currently applied values for CPAP, IPAP and EPAP / PEEP, respiratory frequency (f) and volume. Spontaneous or mechanical respiratory phase switches and the pressure change are also shown in graphical form. Ventilation parameters can be set in standby mode and in ventilation mode. The device is operated by a number of keys that give direct access to the most important parameters, such as IPAP, EPAP / PEEP, frequency, inspiration time and volume. A dial is used to navigate through the menu. Parameters are shown in an LC display.

A key code is used to prevent therapy values from being adjusted inadvertently. Operation is locked when a padlock symbol is shown on the display. In the Clinical menu, it is possible to show ventilation curves such as flow curves and pressure/volume loops (VENTI/ologic LS only) in addition to therapy values.

### 2.3.3 Operating status

Three operating states are possible on the therapy device: on, off and standby.

If the device is switched on, therapy is in progress. In standby, the fan is switched off but the device is ready for immediate operation by briefly pressing the on/off switch, provided that the patient circuit is connected correctly. The settings on the device can be adjusted

in standby mode. If the device is switched off completely, the fan and display are also switched off and no settings can be adjusted on the device.

### 2.3.4 Leakage ventilation

When leakage ventilation is used, an exhalation system continuously flushes out the CO<sub>2</sub>-containing exhaled air.

### 2.3.5 Valve ventilation

In this case, exhalation is controlled by the patient valve.

When the single patient circuit with patient valve is used, the patient's exhaled air escapes into the environment through the patient valve. The device controls the patient valve by means of the valve control tube.

When the double patient circuit with patient valve is used (VENTI*logic* LS only), an exhalation tube also routes exhaled air into the ambient air through the device.

### 2.3.6 Therapy modes

The therapy device can be operated in the following therapy modes:

- leakage ventilation: S, T, ST, CPAP, MPVp, MPVv
- valve ventilation: PCV, aPCV, PSV, VCV (VENTI*logic* LS only), aVCV (VENTI*logic* LS only), SIMV, MPVp, MPVv

The mode required for therapy is set on the device by the doctor supervising treatment.

The doctor can activate volume compensation in pressure-controlled modes S, T, ST, TA, PCV, PSV and aPCV. A minimum volume and maximum pressure rise are set to achieve this. If the minimum volume is undershot, the device automatically and continuously increases pressure up to the set maximum pressure (therapy pressure + max. pressure rise).

In controlled modes T, PCV and VCV (VENTI*logic* LS only) and in assisted-controlled modes ST, PSV, aVCV (VENTI*logic* LS only) and aPCV, the doctor can set respiratory frequency in the range from 5 to 45 breaths per minute and inspiration time in the range from 15 % to 67 % of the respiratory period.

In S, ST, PSV, aPCV, aVCV (VENTI*logic* LS only), SIMV, MPVp and MPVv modes, the doctor can select one of 8 trigger stages for inspiration and one of 14 trigger stages for exhalation (not with aPCV, aVCV, MPVp and MPVv).

In ST mode the expiratory trigger can be deactivated. The switch to exhalation is then on a time-controlled basis.

Mouthpiece ventilation can be used in the form of volume-controlled mode MPVv, or pressure-controlled mode MPVp.

If no breath into the device is taken in S mode, therapy pressure is automatically provided at a minimum frequency of 5 breaths a minute.

CPAP mode does not provide any respiratory assistance. The therapy device provides a constant positive therapy pressure in this mode.

The display shows therapy pressure and, as a function of mode, current values for IPAP and EPAP / PEEP and respiratory frequency (f). Depending on the patient circuit used, tidal volume (VT) is displayed in the case of a leakage system and tidal volume on inspiration (VTi) in the case of valve ventilation. When the single patient circuit is used, only tidal volume on inspiration can be measured, whilst with the double patient circuit (VENTI/ogic LS only), total tidal volume can be measured.

Spontaneous or mechanical respiratory phase switches and the pressure change are also shown in graphical form.

### 2.3.7 SIMV mode

SIMV mode (synchronized intermittent mandatory ventilation) is a mixture of mandatory and assisted ventilation.

If there is no spontaneous respiration the device will mandatorily ventilate the patient once the  $T_{\text{apnea}}$  time has elapsed at a respiratory frequency of  $f_{\text{backup}}$ , a ratio of  $T_i/T_{\text{ba}}$  (backup) and an inspirational pressure level of  $P_{\text{SIMV}}$ .

In the case of spontaneous respiration the device switches to assisted ventilation using the set **IPAP** value. The pressure level will then fluctuate cyclically at a frequency of  $f_{\text{SIMV}}$ , a ratio of  $T_i/T_{\text{ba}}$  and an inspirational pressure level of  $P_{\text{SIMV}}$ . The respiratory frequency in this case is dictated by the patient.

### 2.3.8 Mouthpiece ventilation (MPV)

Ventilation modes MPVp and MPVv are a pressure-controlled and a volume-controlled mode for patients with spontaneous breathing who are not subject to invasive ventilation. The MPV modes are typically used with a mouthpiece. The patient has to be capable of closing his or her lips adequately for this purpose.

The MPV modes allow breathing as required and are available for leakage ventilation, single patient circuit ventilation and double patient circuit ventilation systems. The MPV modes have no background frequency. A ventilation stroke is delivered only if the patient triggers inspiration.

Trigger sensitivity, trigger lockout time and pressure rise can all be set individually. LIAM can also be switched on and can be activated via the LIAM key.

If the patient would like to breathe back into the tubing system, a tubing system with an active exhalation valve must be used.

### 2.3.9 Auto switch-on (only leakage ventilation)

The device has an automatic switch-on function. If this is activated, the device can be switched on by taking a breath into the breathing mask. The device is still switched off using the On/Off key .

### 2.3.10 Uninterrupted power supply (UPS)

A built-in battery ensures an uninterrupted power supply in the event of a power outage. Battery running time will depend on the load and operating temperature in question. Detailed information on the different loads with the corresponding battery operating times are provided in section 11. on page 110. The internal battery is automatically charged or maintained in a charged state as long as the device is supplied with power.

### 2.3.11 Mobile power supply

There is the additional option of a mobile power supply by means of one or more replaceable batteries which can be changed while the device is in operation and which are available as accessories.

### 2.3.12 LIAM (insufflation)

The **Lung Insufflation Assist Maneuver** function allows a higher volume to be administered to the patient if the corresponding key is pressed; this supports coughing. This function has to be enabled by the doctor supervising treatment.

### 2.3.13 Nurse call and remote alarm

The device has a remote alarm connection to support the monitoring of patient and device, especially when *VENTIlogic* LS is used for life-support ventilation. All high and medium-priority alarms, together with the **No power supply** alarm are passed to this connection. All other alarms are displayed only on the device itself.

The remote alarm connection can be used to connect the device to the *VENTIremote alarm* remote alarm case. In hospital, the device can be connected directly to the hospital's own internal alarm system.

### **2.3.14 Recording therapy data**

Therapy data are stored in the device on a removable SD card. The VENTiViews PC software can be used to enable a doctor to evaluate the therapy data.

### **2.3.15 Analog output of therapy data**

The device has an interface for connecting to analog box WM 27560. It is used for a time-synchronized display of therapy data such as pressure, flow, leakage and volumes e.g. on a PSG. Mode-specific data, such as trigger times in S mode, can likewise be visualized.

# 3. Safety instructions

---

## 3.1 Safety information

---

Read these instructions for use carefully. They are a component of the device and must be available at all times. Use the device exclusively for the intended purpose described (see "2.1 Intended use" on page 23).

For your own safety and the safety of your patients and in accordance with the requirements of Directive 93/42/EEC, please note the following.

### 3.1.1 Life-support ventilation



**Danger!**  
**Increased resistance in the patient circuit can cause the alarm to fail!**

Attaching an accessory can increase the resistance in the patient circuit. Depending on the settings, this could prevent life-saving alarms from being triggered. For example, if the **Disconnection** alarm fails then the patient may be put at risk.

- Make absolutely certain that the **VT<sub>low</sub>** and **VT<sub>high</sub>** alarms are active.
- Ensure that appropriate values are used for the **VT<sub>low</sub>** and **VT<sub>high</sub>** alarms.
- Check that the alarms are working.
- Carry out an alarm check every time an accessory is changed.



**Warning!**  
**Device failure if incorrect patient circuits used!**

If patient circuits with a diameter smaller than  $\varnothing$  15 mm are used, the device may overheat.

- Use only patient circuits with a diameter of  $\varnothing$  15 mm or more.
- Note that total permitted resistance may be exceeded even in patient circuits with a diameter of  $\varnothing$  15 mm when these are combined with bacteria filters.



**Danger!**  
**The alarm will not work if the wrong settings are used!**

If the **VT<sub>low</sub>** alarm has been deactivated, or incorrect settings have been used, then the alarm will not be triggered. If the patient is dependent on the ventilation device then they are placed at great risk if the alarm fails.

- It is essential to ensure that alarm **VT<sub>low</sub>** is activated for life-support ventilation (VENTI*logic* LS only). Only if these conditions are met can a blockage (stenosis) be detected.
- Set the **VT<sub>low</sub>** alarm appropriately.



**Danger!**  
**Failure of alarm function due to incorrect alarm settings in VCV and aVCV modes (VENTI*logic* LS only)!**

If the **Pressure<sub>high</sub>** and **Pressure<sub>low</sub>** alarms have not been properly set in VCV and aVCV ventilation modes, then these alarms will not be triggered. If these alarms are not triggered the patient may be put at risk.

- Make absolutely certain that the **Pressure<sub>high</sub>** and **Pressure<sub>low</sub>** alarms are active in the VCV and aVCV ventilation modes.
- Ensure that appropriate values are used for the **Pressure<sub>high</sub>** and **Pressure<sub>low</sub>** alarms.



**Warning!**

- An alternative ventilation option (e.g. a replacement device or a manual ventilating bag) needs to be kept to hand for patients who are dependent on a ventilation device, in case the device fails.
- It is critical that patients who are dependent on the ventilation device are monitored by the person caring for the patient. Otherwise it is possible that there will be no reaction to any alarms occurring on the device.
- Ensure that any alarms and malfunctions can be seen at all times and that the person caring for the patient can take the necessary measures. Recourse can be had to the VENTI*remote alarm* remote alarm case or the hospital's own internal alarm system to support monitoring.
- With the single patient circuit and patient valve, the system only allows the volume given off by the device to be displayed and monitored. With the valve system, exhaled volume can only be displayed reliably with a double patient circuit with patient valve (VENTI*logic* LS only). For this reason, you should ensure that patients dependent on the ventilation device are ventilated with a double



patient circuit or, if a single patient circuit is used, that exhaled volume is monitored separately.

### 3.1.2 Operating the device



#### **Warning!**

- Do not cover the device with blankets etc. The air inlet would be blocked and the device could overheat. This may lead to inadequate therapy and to damage to the device.
- All device openings must be freely accessible and may not be blocked by objects.
- Maintain a safe distance between the therapy device and devices which emit HF radiation (e.g. cell phones - see page 120), otherwise there may be malfunctions.
- In order to prevent reinfection in the case of infectious diseases, we recommend using a bacteria filter.
- The device is not suitable for use in an environment at risk of explosion.
- Do not use the device in an MRI environment or in a hyperbaric chamber.
- The device may not be operated with flammable anesthetics, nor may flammable anesthetics be kept in the vicinity of the therapy device. Risk of fire/explosion!
- Ensure that ventilation tubes and cables are routed so that they cannot lead to the patient being strangled.
- Ensure that there are no small parts close to the patient, otherwise they might get into the patient's respiratory flow and put him/her at risk.
- Use only masks prescribed by your physician or which you have been given by your medical technology supervisor. Using different masks jeopardizes the success of therapy.
- Masks of third-party manufacture may only be used following authorization by the manufacturer. The success of therapy is put in jeopardy by the use of unauthorized masks or other types of patient/ventilator interface.
- If a pneumotachograph with a high flow resistance is used to determine flow at the start of therapy or to check it, this may restrict trigger function. In the event of queries, contact the manufacturer.
- No antistatic or electrically conductive tubes may be used.
- Please observe Section "6. Hygiene treatment" on page 68 to prevent infection or bacterial contamination.

- With valve ventilation, masks with integrated or separate leakage ventilation are prohibited.
- With leakage ventilation, only full-face masks with an integrated emergency exhalation valve may be used.
- An exhalation system must always be used with leakage ventilation, otherwise the CO<sub>2</sub> concentration in the breathing mask and tube would rise to critical values and thus obstruct breathing.
- Ventilation modes MPVv and MPVp for mouthpiece ventilation may only be used on patients with a stable independent respiratory drive.
- Always use a suitable water trap if the patient produces a great deal of secretion during ventilation, otherwise fluid may get into the device. This can lead to damage to the device and thus a risk to the patient.
- In ventilation modes with a trigger function on inspiration, hyperventilation may result.
- Only converter cable USB-RS485 WM 93318, SpO<sub>2</sub> *module* WM 27280 or converter box WM 93316 may be connected to the RS485 serial port.

### **Caution!**

- Check whether the power supply of the device matches that of your local power supply. The device can operate with voltages of 110-230 V. It automatically adapts to one of these voltages.
- Ensure that the power cord is connected correctly. Always secure the power plug with the cable-securing clip to prevent the plug being removed by mistake.
- The device must be connected to an easily accessible socket so that the plug can be taken out quickly in the event of a fault.
- Do not use sockets with an On/Off switch or dimmable sockets.
- Do not set up the device close to a radiator and do not expose it to direct sunlight, as this could overheat the device. Condensation could also form in the humidifier used and condense in the patient circuit.
- Never push objects, cloths etc. into the openings of the device. This may block inlets and outlets and lead to damage to the device.
- The device must be on standby or switched off for the SD card to be removed or inserted, otherwise therapy data may be lost.
- Ensure that only those ventilation programs which should be accessible for the respective patient are enabled.

**Note:**

- The use of accessories in the respiratory flow, such as bacteria filters, for example, may change the characteristics of the device. Subsequent addition of these accessories may make it necessary to reset device parameters. The total resistance of the ventilation system must not exceed 6 hPa at 60 l/min for adults and 6 hPa at 30 l/min for children.

### 3.1.3 Mobile operation

**Warning!**  
**Risk of injury as a result of handling the replaceable battery incorrectly!**

Incorrect handling of the replaceable battery may lead to fires and injure the patient.

- Do not open, crush, deform, puncture or dismantle the replaceable battery.
  - Do not drop the replaceable battery.
  - Do not introduce any foreign bodies into the replaceable battery.
  - Do not immerse the replaceable battery in water or other liquids.
  - Do not short-circuit the replaceable battery.
  - Do not put conductive objects in contact with the connections of the replaceable battery.
  - Keep the replaceable battery away from fire or heat.
  - Only use and charge the replaceable battery with the system provided for it.
  - Only replace the replaceable battery with a genuine replaceable battery.
  - Children may only use the replaceable battery under supervision.
  - If the replaceable battery has been handled incorrectly, have it checked by the manufacturer or an authorized specialist dealer.
- When operated on a wheelchair, this system requires a certificate of conformity. To obtain this, consult a specialist dealer authorized by the manufacturer; this dealer will also perform the attachment.

**Caution!**

- The internal battery is not intended for mobile operation. Always use one (or several) of the replaceable batteries available as accessories for mobile power supply. Ensure before mobile operation that the internal battery is fully charged so that an uninterrupted power supply is ensured in an emergency.
- Protect the therapy device in the carrying bag from direct sunlight and rain, using a sunshade or rain cover for example. The carrying bag itself provides only brief protection from sunlight and rain. Strong sunlight can force ambient temperature up beyond the permitted limits. The consequence of this may be that the batteries in the device will not longer function.

- During mobile operation there may be problems with the trigger. This can result in inadequate ventilation. Have your physician adjust the trigger settings or select a monitored ventilation mode.

**Note:**

- When planning your time, be aware that at low or very high outdoor temperatures, battery running time is considerably reduced.

### 3.1.4 Oxygen supply



**Warning!**

- If oxygen is being supplied to the respiratory flow, smoking and naked flames are forbidden. **Risk of fire.** The oxygen can accumulate in clothing, bed linen or hair. It can only be removed by thorough ventilation.
- It is essential to follow the safety instructions in the instructions for your oxygen system.
- Too high or too low an oxygen supply can be toxic and lead to severe complications. We therefore recommend monitoring the oxygen supply with an oxygen sensor. This oxygen sensor can replace neither blood gas analysis nor direct FiO<sub>2</sub> measurement.
- **Risk of fire.** Always shut off the oxygen supply first at the end of therapy. Then leave the therapy device to run for a short time before turning it off, otherwise some residual oxygen will remain in the device. In the event of a fault, this could lead to a risk of fire.
- To supply oxygen, use only the therapy device connection provided for this purpose. Never supply oxygen via the patient/ventilator interface or the T-adaptor, otherwise the oxygen supply cannot be switched off automatically if a fault occurs.

**Note:**

- Supplying oxygen via a connection not intended for this purpose leads to an erroneous volume display, as the oxygen flow cannot be included in the measurement.

### 3.1.5 Transport/accessories/spare parts/maintenance

#### Caution!

- Be aware that pressure at the patient connection opening may rise during exhalation if you connect accessories (e.g. bacteria filter or respiratory air humidifier).
- The UPS works only if the internal battery is present and charged. Recourse can only be had to the replaceable battery obtainable as an accessory during an interruption to the power supply when the device is switched on and the internal battery is present.
- If the therapy device and the batteries have been stored or transported at operating temperatures outside those quoted in the instructions for use, the therapy device may be commissioned only once the temperature of the device and the batteries is within the temperature range permitted for operation.
- Do not transport the therapy device with the humidifier fitted, otherwise residual water may run into the therapy device and damage it.
- The remote alarm connection is designed to switch a small protective voltage (see "11. Technical data" on page 110). The device can be damaged by excessively high voltages.
- If third-party items are used, functional failures may occur and fitness for use may be restricted. Biocompatibility requirements may also not be met. Please note that in such cases, any claim under warranty and liability will be voided if neither the accessories nor genuine replacement parts recommended in the instructions for use are used.
- Have servicing and maintenance work carried out only by or by specialist staff expressly authorized by the manufacturer.
- Have modifications to the device carried out only by or by specialist staff expressly authorized by the manufacturer.

#### Note:

- If the therapy device is stored or not used for a prolonged period, the battery will discharge. This is a property of rechargeable batteries and is not a malfunction, so we recommend checking charge status regularly and recharging the battery with the aid of the therapy device if required.
- **Commercial Transport:** If the therapy device is commercially transported, the device should be classed as a dangerous good (DG) class 9 - miscellaneous because of the lithium battery (with >100 watt hours) it contains. For that

reason, the therapy device and/or the associated lithium batteries are subject to the transport terms of the regulation on the air transportation of dangerous goods (IATA: International AIR Transport Association), the IMDG Code (International Maritime Dangerous Goods Code) for maritime transport, as well as the ADR Code (European Agreement concerning the International Carriage of Dangerous Goods by Road for Europe) for transport by road.

- In the event of error messages, please see “8. Troubleshooting” on page 82.

## 4. Set up device

---



### **Warning!**

#### **Device failure if incorrect patient circuits used!**

If patient circuits with a diameter smaller than  $\varnothing$  15 mm are used, the device may overheat.

- Use only patient circuits with a diameter of  $\varnothing$  15 mm or more.
- Note that total permitted resistance may be exceeded even in patient circuits with a diameter of  $\varnothing$  15 mm when these are combined with bacteria filters.



#### **Note on using Intersurgical® patient circuits**

When using Intersurgical® patient circuits ref. 5183064 and ref. 5083 (and other single-patient circuits in which Intersurgical valves from the patient circuits mentioned are used) the volume display on the device may deviate. The volume displayed may deviate from that actually delivered by up to 105 ml.

- Use genuine patient circuit WM 27181 to avoid this deviation in the display.

The therapy device can be operated with both leakage and valve ventilation. The doctor supervising treatment or the authorized specialist dealer converts the device to the variant appropriate for the patient's form of treatment. The necessary settings on the device are likewise made by the doctor supervising treatment.

You need only follow the relevant section depending on which patient circuit is being used.

Different functions and connection options for accessories are available depending on the patient circuit. This is clearly indicated in the relevant sections.

### 4.1 Set up and connect the device

---

Set up the device on a flat surface, e.g. on a bedside cabinet or on the floor next to the bed. Maintain a distance of at least 5 cm between the wall and the rear of the device, as the air inlet is at the rear of the device. A distance of at least 5 cm should also be maintained from the left-hand side of the device to allow the heat produced by the device to escape.

### **Caution!**

Do not cover the device with blankets etc. The air inlet would be blocked and the device could overheat. This may lead to inadequate therapy and to damage to the device.

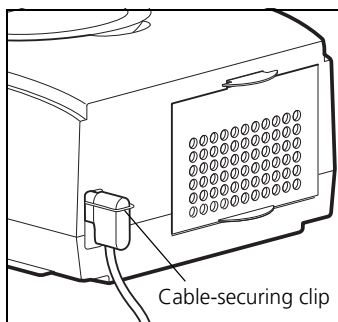

1. Connect the power cord to the power connector of the device.  
To do this, lift the cable-securing clip, plug the plug into the power connector and flip the cable-securing clip over the plug. Always secure the power plug with the cable-securing clip to prevent the plug being removed by mistake.
2. Connect the power cord to a power supply socket.  
The therapy device is designed for a supply voltage of 115 V ~ and 230 V ~.  
The green LED for power supply comes on and the start screen appears in the display.

Now leave the device connected to the power supply for at least 6 hours to charge the internal battery.

The device is now operational.

## **4.2 Patient/ventilator interfaces**

---

The therapy device is intended for operation with nasal masks, oronasal masks and full-face masks as well as with mouthpieces, endotracheal cannulas and endotracheal tubes. It is essential to follow the instructions for use of the patient/ventilator interface in question.

## **4.3 Connect valve ventilation**

---

When using valve ventilation, patient/ventilator interfaces with leakage openings may not be used. Always use a patient valve. Inspiration and exhalation is controlled using the patient valve.

### **4.3.1 Single patient circuit**

The single patient circuit consists of a ventilation tube, a pressure-measurement tube, a valve control tube and a patient valve. The patient/ventilator interface must be connected directly to the patient valve.





### Caution!

The patient valve may not be covered when the device is in operation, otherwise the exhaled air may not be routed away, obstructing breathing.

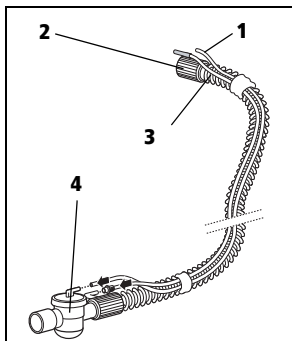
Proceed as follows to connect the single patient circuit to the therapy device.



1. Plug the free end of the ventilation tube (2) onto the device outlet port.
2. Now connect the blue connector stub of the pressure-measurement tube (1) to the connection of the device which is likewise blue and marked  $P$  .
3. Connect the valve control tube (3) to the connection of the device marked  $\downarrow$  .

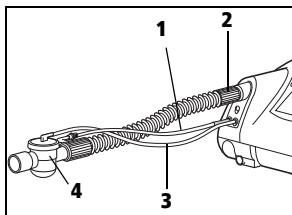

4. Connect the patient valve (4) to the patient/ventilator interface, e.g. a mask.

It is essential to follow the instructions for use of the patient/ventilator interface and of the patient circuit.

### 4.3.2 Double patient circuit (VENTIlogic LS only)

In addition to the ventilation tube which delivers air to the patient, the pressure-measurement tube and the valve control tube, the double patient circuit also has an exhalation tube which routes exhaled air back to the device and into the ambient air. On the double patient circuit, the patient valve is located on the exhalation tube.

Proceed as follows to connect up the double patient circuit.

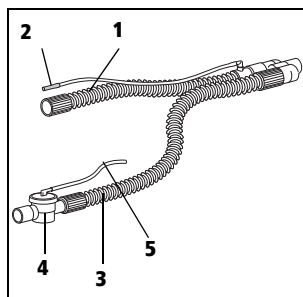

1. Plug the ventilation tube (1) onto the device outlet port of the .
2. Plug the exhalation tube (3), on the end of which is the patient valve (4), onto the device inlet port for exhaled air underneath the device outlet port.
3. Now connect the blue connector stub of the pressure-measurement tube (2) to the connection of the device which is likewise blue and marked  $P$  .

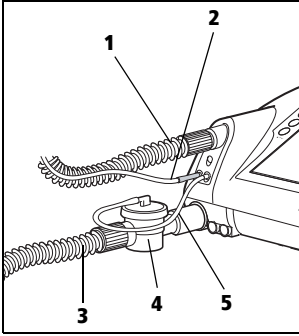

The pressure-measurement tube is the same length as the ventilation tube and leads to the Y-connecting piece where the ventilation tube and the exhalation tube are brought together.

4. Connect the valve control tube (5) to the connection of the device marked .

The valve control tube leads straight from the patient valve to the connection on the device and is therefore shorter than the pressure measuring tube.

5. Connect the patient/ventilator interface, e.g. a mask.

It is essential to follow the instructions for use of the patient/ventilator interface and of the patient circuit.

## 4.4 Connect leakage ventilation

### Connect leakage ventilation using click adapter

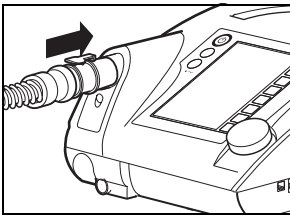

Proceed as follows to connect up the leakage circuit.

1. Plug the click adapter of the patient circuit onto the ventilation outlet on the device.
2. Connect the patient/ventilator interface, e.g. a mask.

It is essential to follow the instructions for use of the patient/ventilator interface and of the exhalation system.

### Connect leakage ventilation using standard tapered connector

For leakage operation, an adapter is available as an option to allow tubes with sleeves with an internal diameter of  $\varnothing 22$  mm and a pressure-measuring tube with an internal diameter  $\leq \varnothing 5$  mm to be used. If the device is equipped with this adapter, proceed as follows to connect the tube:

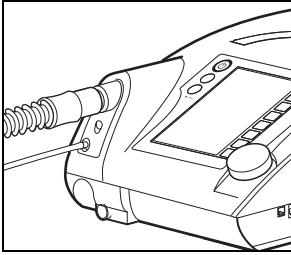

1. Push the ventilation tube onto the device outlet port of the therapy device.
2. Now connect the pressure-measurement tube to the connection on the device marked **P** .
3. Connect the patient/ventilator interface, e.g. a mask.
4. It is essential to follow the instructions for use of the patient/ventilator interface and of the exhalation system.
5. Note that maximum flow rate and the accuracy of dynamic pressure may deviate if you are not using tubes from the manufacturer.

## Information relating to a separate exhalation system

### Caution!

Always use an exhalation system. Used air containing carbon dioxide escapes from the patient/ventilator interface (e.g. a mask) through the exhalation system. Without an exhalation system, the CO<sub>2</sub> concentration in the patient/ventilator interface and the ventilation tube would rise to critical values and thus obstruct breathing.

An exhalation system can either be integrated in the patient/ventilator interface, e.g. a mask, or must be plugged in between the patient/ventilator interface and the patient circuit in the form of an accessory.

If the patient/ventilator interface, e.g. the mask, does not have an exhalation system, a separate exhalation system, e.g. Silentflow 2, must be used.

The exhalation system also allows a patient to breathe through his or her nose for a short time, even if the device were to fail. In the case of full-face masks, breathing in the event of a fault is through an emergency exhalation valve on the mask.

## Connect separate exhalation system (only with leakage ventilation)

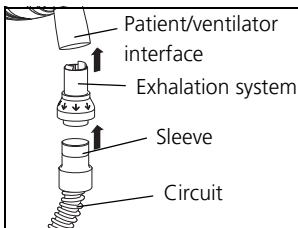

To connect a separate exhalation system, proceed as follows.

1. Plug the exhalation system into the sleeve of the circuit.
2. Connect the patient/ventilator interface to the exhalation system.

Follow the instructions for use for the exhalation system and for the patient/ventilator interface.

## Connect circuit for mouthpiece ventilation

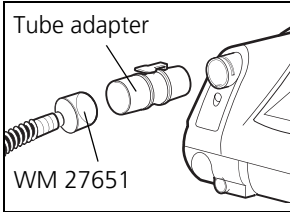

Proceed as outlined below to connect the leakage circuit for mouthpiece ventilation (WM 27651).

1. Plug the tube adapter supplied onto the ventilation outlet on the device.
2. Plug the leakage circuit for mouthpiece ventilation onto the tube adapter.
3. Connect the patient/ventilator interface, e.g. a mouthpiece. It is essential to follow the instructions for use for the patient/ventilator interface..

## 4.5 Connect bacteria filter

---

### Caution!

The bacteria filter represents an additional resistance in the air flow. This can cause a change to the response characteristics of the trigger. If a bacteria filter is connected subsequently, the doctor must therefore check the device parameters and may need to reset them.

### Note:

The bacteria filter may not be operated on the device for more than 24 hours. Follow the instructions relating to period of use in "6. Hygiene treatment" on page 68.

If the therapy device is intended for use by several patients (e.g. in a hospital), a bacteria filter must be used to prevent infections.

### 4.5.1 Leakage ventilation

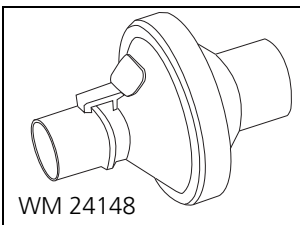

In combination with **leakage ventilation**, use bacteria filter WM 24148.

If the bacteria filter is used alone, it is connected directly to the device outlet port and the ventilation tube is plugged onto the bacteria filter.

## 4.5.2 Valve ventilation

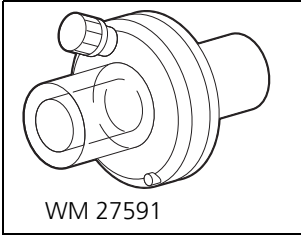

In combination with **valve ventilation**, use bacteria filter WM 27591.

If the bacteria filter is used alone, it is connected directly to the device outlet port and the ventilation tube is plugged onto the bacteria filter.

If a humidifier and/or an oxygen sensor is to be connected as well, a different sequence applies.

### **Combination with a humidifier**

1. Connect the bacteria filter directly to the therapy device.
2. Connect the humidifier to the outlet of the bacteria filter.
3. Connect the patient circuit to the humidifier.

### **Combination with an oxygen sensor**

1. Connect the oxygen sensor directly to the therapy device.
2. Connect the bacteria filter to the outlet of the oxygen sensor.
3. Connect the patient circuit to the bacteria filter.

### **Combination with an oxygen sensor and a humidifier**

1. Connect the oxygen sensor directly to the therapy device.
2. Connect the bacteria filter to the outlet of the oxygen sensor.
3. Connect the humidifier to the outlet of the bacteria filter.
4. Connect the patient circuit to the humidifier.

## 4.6 Therapy with oxygen supply

---

### 4.6.1 Supplying oxygen



#### **Warning!**

- If oxygen is being supplied to the respiratory flow, smoking and naked flames are forbidden. **Risk of fire.** The oxygen can accumulate in clothing, bed linen or hair. It can only be removed by thorough ventilation.
- To supply oxygen, use only the therapy device connection provided for this purpose. Otherwise the oxygen supply cannot be stopped automatically if a fault occurs. Never supply oxygen via masks or the T-adapter.

#### **Note:**

Supplying oxygen via a connection not intended for this purpose leads to an erroneous volume display, as the oxygen flow cannot be included in the measurement.

A supply rate of max. 15 l/min at < 1000 hPa pressure at the inlet for the oxygen supply is permitted.

Use an oxygen sensor to monitor oxygen supply.

The oxygen source must have an independent flow regulation device. Ensure that you only set the oxygen flow rate prescribed by the doctor on your oxygen supply device. It is essential in this case to follow the safety instructions for handling oxygen as well as the instructions for use of the oxygen device used.

#### **Caution!**

If the oxygen is humidified before being supplied, a tank with an overpressure valve must be used, otherwise an overpressure will result in the event of faulty operation which could lead to the humidification tank bursting or to the oxygen supply tubes slipping off.

Proceed as follows to supply oxygen:

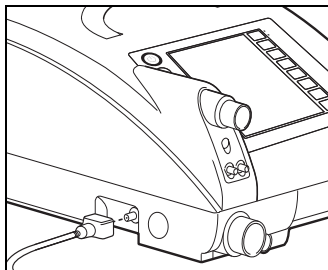

1. Switch on the therapy device.
2. Connect the O<sub>2</sub> coupling supplied to the connector stub provided on the therapy device.
3. Connect the oxygen source to the O<sub>2</sub> coupling.
4. Start the supply of oxygen. When doing so, it is essential to follow the instructions for use of the oxygen source in question. The device can now be operated normally.

Proceed as follows to end supply of oxygen:

1. Shut off the oxygen supply.
2. Continue operating the device for a while without an oxygen supply to flush the remaining oxygen out of the device. If this instruction is not followed, there is a risk of fire in the event of a malfunction.
3. Remove the adapter for the oxygen supply from the device.
4. Switch off the device. The safety valve for the oxygen supply automatically shuts off the oxygen supply after 1 minute.

Oxygen can be supplied via an oxygen concentrator via the central gas supply system (only with corresponding pressure reducer) of a hospital, in the form of liquid oxygen with a continuous flow or of an oxygen cylinder with a corresponding pressure reducer.

## 4.6.2 Measure oxygen concentration (only valve ventilation)

The oxygen sensor can only be used in conjunction with valve ventilation.

During measurement, oxygen concentration is averaged over several breaths and displayed. Measured values depend on therapy pressure and on the temperature of ambient and respiratory air. This is not a FiO<sub>2</sub> measurement, but the mean value of oxygen concentration on inspiration.

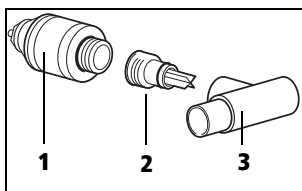

1. The adapter is delivered in three parts: the oxygen sensor (1), the T-adaptor (3) and an air management adaptor (2). Screw the air management adaptor onto the oxygen sensor.

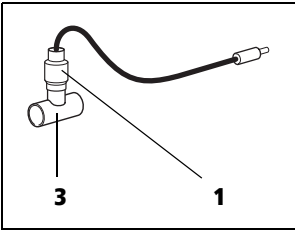

2. Plug the oxygen sensor (1) and air management adapter into the T-adapter (3).

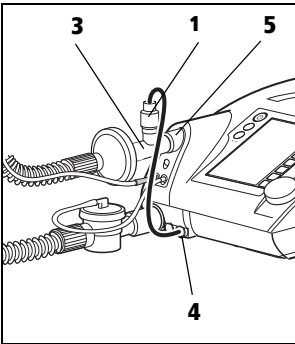

3. Plug the T-adapter (3) onto the device outlet port (5).
4. Connect the sensor (1) to the oxygen measuring jack (4) with the aid of the cable.
5. Connect the patient circuit - with a bacteria filter if required - as shown in the illustration.
6. Calibrate the oxygen sensor (see "7.3 Calibrate oxygen sensor (only valve ventilation)" on page 79).

### 4.6.3 Measuring oxygen saturation and pulse

Using the optional, non-invasive SpO<sub>2</sub> *module*, oxygen saturation levels (SpO<sub>2</sub>), heart rate and alarms can be measured, showed on the display of the device and saved to the SD-card.

The SpO<sub>2</sub> and heart rate parameters can each be monitored using upper and lower alarm limits, synchronized using VENTiViews software and represented on a computer screen with other ventilation data.

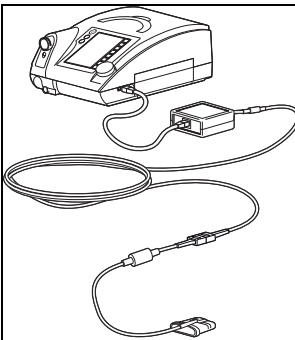

1. Connect the SpO<sub>2</sub> *module* to the serial interface on the device. The displays and alarms for oxygen saturation and pulse rate are activated via this.
2. Attach the SpO<sub>2</sub> sensor onto the fingertip and wait until the measured values are shown on the display.



**Note**

The SpO<sub>2</sub> *module* supports diagnosis and patient monitoring. The SpO<sub>2</sub> *module* may only be used for diagnosis in conjunction with other indications of disease and symptoms. No clinical assessment may be made solely on the basis of SpO<sub>2</sub> *module* results.

**Note**

Use only SpO<sub>2</sub> sensors to measure oxygen saturation.

## 4.7 Operation in the event of a power failure

---

If the power supply should ever fail, the internal battery of the therapy device automatically assumes supply of the device.

The message **No power supply** appears. The green power supply LED goes out. The battery operating time will depend on the load and temperature range. Detailed information on the different loads with the corresponding battery operating times are provided in section 11. on page 110.

As soon as the power supply is restored, the device is automatically supplied from the power supply again and the internal battery is charged. The green power supply LED comes on and the consecutive segments in the battery symbol indicate the charging process in the display. If you are using a replaceable battery, then in the event of a power outage, the replaceable battery will be used first and only then the internal battery. When the batteries are being charged, the sequence is reversed.

**Note**

- If the alarm **Battery capacity critical** appears, action is required. In this case, only about 25 % capacity is left. This is enough for about 15 minutes. Keep an alternative ventilation option to hand.
- If the alarm **Battery capacity highly critical** appears, there is less than 10 % capacity remaining. The device will switch itself off in a few minutes. Use the alternative ventilation option at once.

# 5. Operation

---

## 5.1 Controls

---

### 5.1.1 Function keys

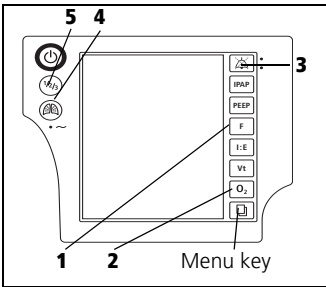

The following functions can be called up directly in ventilation mode by pressing the relevant key on the device.

- LIAM (insufflation) (4)
- Acknowledge alarms (3)
- Select a program (5)
- Calibrate O<sub>2</sub> sensor (2)

After these keys are pressed, the corresponding menu appears in the display. You can navigate within the menu using the dial (see “Navigating with the dial” on page 51).

The other functions (1) can only be operated by the doctor.

#### Menu key

Use the menu key to switch from **Monitor** to **Menu**.

Current values during therapy are displayed in **Monitor**. You can make settings to the device in **Menu**.

The menu key has other functions (e.g. **back**) depending on context. The current function is always displayed on the left of the display next to the menu key.

#### Acknowledge alarm

Use the alarm acknowledgement key to acknowledge an acoustic alarm and mute it for 120 seconds.

## 5.1.2 Navigating with the dial

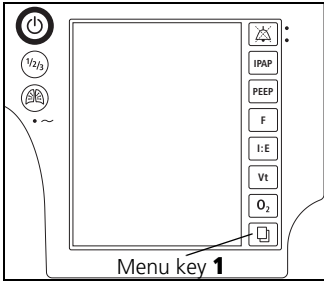

The dial is the central control of the therapy device. You can use the dial to select menu items, navigate within the menu windows and set values for individual menu items.

To familiarize yourself with navigation using the dial, we recommend switching to **Menu** first. Press the menu key (**1**) to do so. You can then try out the functions described below.

### Select menu items

- Move the dial clockwise to move the selection bar in the display downwards.
- Move the dial anticlockwise to move the selection bar in the display upwards.
- Press the dial to confirm selection of a menu item and to open the corresponding submenu or to select a value you want to change.

### Set values

- Move the dial clockwise to increase a value.
- Move the dial anticlockwise to decrease a value.
- Press the dial to save a value.

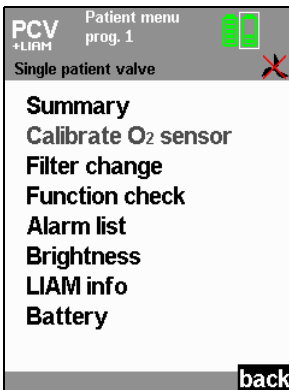

### Exit menu item

Move the dial clockwise until the selection bar in the display is on **back**, **cancel** or **close** depending on context. Then press the dial. The display switches back to the next menu up.

Alternatively, you can exit a menu item by pressing the menu key (**back**, **cancel** or **close** will appear in the display to the left of the menu key depending on context).

### Select night mode

If you press the dial during therapy, you will activate night mode. The display then goes dark so that only the bar chart with the pressure display is visible. Therapy continues as normal. The display switches back on if you press the dial again or any other key. The display switches back on automatically if an alarm situation arises.

## 5.2 Start up the device

---

### 5.2.1 Operating states

Three operating states are possible on the therapy device: on, off and standby.

If the device is switched on, therapy is in progress.

In standby, the blower is switched off, but the device is immediately operational with a brief press of the On/Off key as long as the patient circuit is connected correctly. Settings can be made on the device in standby mode.

If the device is switched off completely, the blower and the display are likewise switched off and no settings can be made on the device.

#### Note

On standby, the display switches off if it is not used for 5 minutes (applies only in patient mode).

### 5.2.2 Starting up

1. Connect the device to the power supply with the aid of the power cord. The standby screen appears in the display after about 5 seconds.
2. First, perform a function check (see "7. Function check" on page 75).
3. Connect the patient circuit to the patient/ventilator interface. It is essential to follow the relevant instructions for use for the patient/ventilator interface, the patient circuit and, if appropriate, the exhalation system.

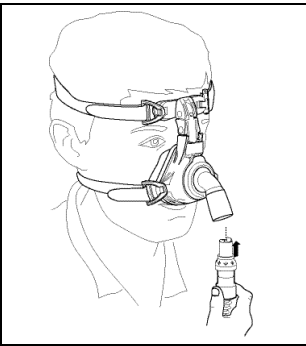

#### Caution!

Always use a separate exhalation system for leakage ventilation (e.g. Silentflow leakage ventilation), otherwise the CO<sub>2</sub> concentration would rise to critical values in the patient/ventilator interface and tube and thus obstruct the patient's breathing.

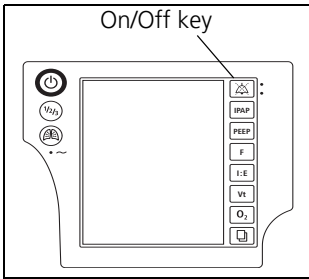

- To switch on the device, press the On/Off key  briefly. The device is now in ventilation mode. The patient menu can be accessed via the menu key.

When Auto switch-on (only with leakage ventilation) is activated, you can also put on the patient/ventilator interface and switch on the therapy device by taking a breath (see "5.4 Activate/deactivate Auto switch-on (only leakage ventilation)" on page 56). The operating hours and the software version appear in the display for about 3 seconds.

The device starts to pump air through the patient circuit. The display switches to the default display.

### 5.2.3 Displays on screen

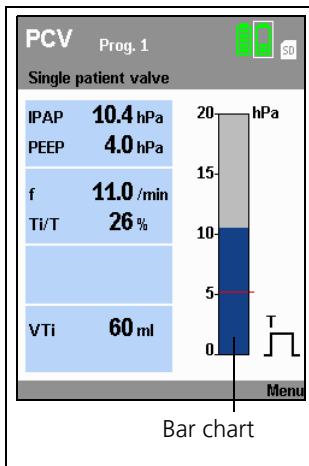

Ventilation parameters such as set therapy mode, therapy pressures (CPAP pressure only in CPAP mode) in hPa, the selected patient circuit and current respiratory frequency in 1/min are shown in the display.

**Note:** 1.01973 hPa correspond to 1 cm H<sub>2</sub>O.

The bar chart shows the pressure curve for inspiration and exhalation.

The respiratory phase change display shows whether the current respiratory phase was triggered spontaneously by the patient (**S**) or by the machine (**T**). Depending on respiratory phase, the display switches from left (inspiration) to right (exhalation).

See the section entitled " Symbols used in the display" on page 18 for an explanation of the other symbols in the display.

## 5.3 Handling batteries

---

The device is equipped with an internal battery which supplies the therapy device with power in an emergency.

The therapy device can also be equipped with a replaceable battery available as an accessory.

### 5.3.1 Charging batteries





The batteries are charged automatically as soon as the therapy device is connected to the electricity supply. The therapy device always charges the internal battery first, followed by the replaceable battery (if present).

#### Notes

- Run from the mains for at least 12 hours prior to using the battery for the first time.
  - The batteries have no memory effect. This means you can charge the batteries even if they are not empty.
  - In typical use, the batteries have a service life of at least 600 charge/discharge cycles. The batteries must be replaced in accordance with the intervals listed in Section 9. on page 96. If the life of the batteries is exhausted before that, the message **Service life ended. Have internal battery replaced/Have replaceable battery replaced** appears in the display.
  - Note the instructions on battery care (see “9.2.1 Care of batteries” on page 97).
1. Connect device to the power supply.  
The charging process starts automatically.
  2. If the display is no longer flashing and/or the display is showing 100 % capacity, the relevant battery has been charged.  
If you have a replaceable battery, you can now disconnect the device from the electricity supply for mobile use.

### 5.3.2 Capacity/charge status display on device

When the device is switched on, you can read off the capacity of the battery in the default display:

Symbol	Meaning
	Battery display green: battery capacity over 25 %
	Battery display orange: battery capacity below 25 %
	Battery display red: battery capacity below 10 %
	Battery not ready for use: – battery defective or – battery too cold or – battery too hot
	Battery not present

### 5.3.3 Battery menu

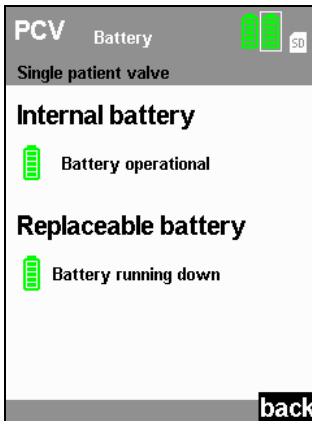

This menu gives you a summary of the state of any batteries present. In the patient menu, select the **Battery** menu item using the dial:

- Internal battery: always present and supplies the device with power in an emergency.
- Replaceable battery: available as an option and allows mobile use of the device independent of an electricity supply.
- The accuracy of the display depends on the load on the device (load due to patient breathing, current operating temperature). The display is continuously updated.

### 5.3.4 Operation with replaceable battery

You can change the battery both with the device switched off and during operation.

#### Note

- Only remove the replaceable battery. The internal battery may only be replaced by the manufacturer or an authorized specialist dealer.
- Use only genuine replaceable batteries from the manufacturer.

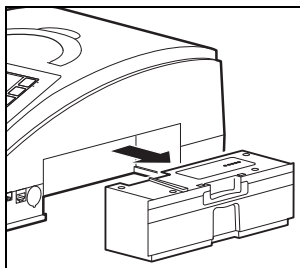

1. Press down the latch of the replaceable battery and keep it depressed.
2. Remove the replaceable battery.
3. Push the replaceable battery into the device until you hear the latch engage.  
When the device is switched on, the symbol for the replaceable battery appears in the status line and a beep sounds.
4. Use the status line and the Battery menu to see the charge status of the replaceable battery.

## 5.4 Activate/deactivate Auto switch-on (only leakage ventilation)

---

When Auto switch-on is activated, the therapy device switches on automatically as soon as you breathe into the patient circuit. The device does not switch off again automatically when the patient takes off the patient/ventilator interface. You can only switch off the therapy device using the On/Off key .

#### Note

Auto switch-on can only be activated or deactivated in standby mode.

1. Start up the therapy device (see "5.2 Start up the device" on page 52).
2. Press the menu key  to do so. The patient menu appears in the display.



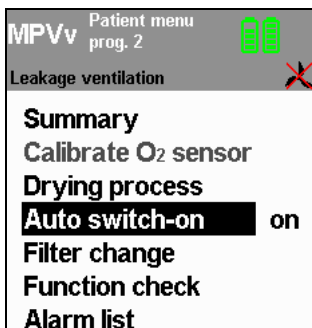

3. Use the dial to select the menu item **Auto switch-on** and confirm the selection by pressing the dial. Now select **on** or **off** using the dial. Confirm the selection by pressing the dial. The selection bar switches back to **Auto switch-on**. The current setting (on/off) is now shown again in the **Auto switch-on** menu line.
4. Exit the menu again by pressing the menu key, now assigned the **back** function. Auto switch-on is now activated or deactivated.

## 5.5 Alarm list

---

### 5.5.1 Storage of alarms

All alarm types listed in the tables "Physiological alarms" and "Technical alarms" are recorded in an alarm list with date, time and duration once the alarm threshold is reached. Up to 200 alarms can be stored. After that, the oldest alarm in each case is overwritten.

To call up the alarm list, select the menu item **Alarm list** in the patient menu using the dial and confirm your selection by pressing the dial.

The alarm list is retained even if the entire power supply (power supply and internal battery) fails.

In this case, the data can be called up for up to two years. The alarm list is overwritten after two years or when servicing is carried out.

Alarms are always retained in the event of a power failure.

## 5.6 Adjust brightness

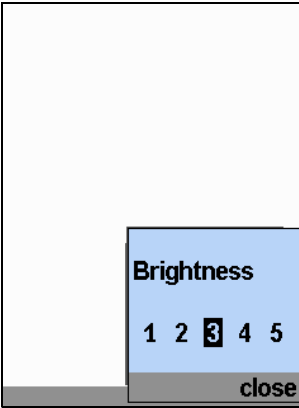

You can change the brightness of the display:

1. In the patient menu, select the **Brightness** menu item using the dial.
2. Select the desired brightness level using the dial.
3. Confirm your selection by pressing the dial.

### Tip

To switch off the display completely during therapy (at night for example), press the dial during therapy. Switch the display back on by pressing the dial again.

## 5.7 LIAM info

### Note

A detailed explanation of the LIAM function can be found in the section entitled “5.10 LIAM (insufflation)” on page 60.

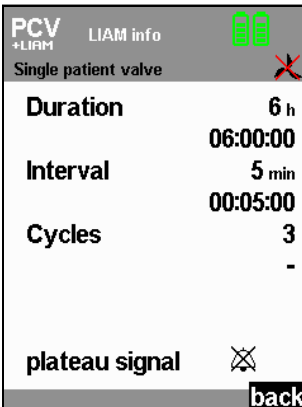



1. In the patient menu, use the dial to select the **LIAM info** menu item.
2. Confirm your selection by pressing the dial.

You will find the following values and their residual running times under **LIAM info**:

- Duration
- Interval
- Cycles
- Plateau signal (activated or deactivated)

## 5.7.1 Activate/deactivate plateau signal

In patient mode you can switch the **plateau signal** on or off under **LIAM info**:

1. In the **LIAM info** menu, use the dial to select the **plateau signal**.
2. Confirm your selection by pressing the dial.
3. Use the dial to select the status plateau signal on  or plateau signal off .
4. Confirm your selection by pressing the dial.

## 5.8 Overview

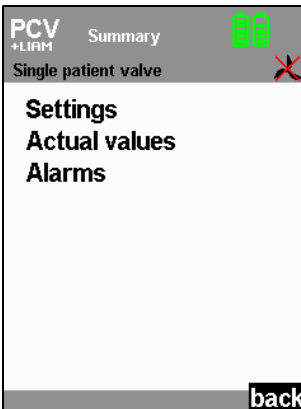

Under the menu item **Displays > Summary**, you can view the current settings and alarms of the respectively configured programs as well as the actual values.

1. In the Patient menu, use the dial to select the **Summary** menu item.
2. Confirm your selection by pressing the dial.
3. Use the dial to select the desired submenu.
4. Confirm your selection by pressing the dial.

## 5.9 Humidifier for patient circuits with patient valve

We recommend humidifiers HC 850 or HC 550 from Fisher & Paykel with the corresponding patient circuit or humidifier PMH5000 from Wilamed. Follow the associated instructions for use.

# 5.10 LIAM (insufflation)

## 5.10.1 Information about the function

LIAM stands for **L**ung **I**nsufflation **A**ssist **M**aneuver. LIAM is a pressure-controlled hyperinsufflation maneuver with the aim of administering an increased tidal volume which can be used in all ventilation modes except CPAP and SIMV. LIAM can be used to support coughing or for alveolar recruitment (similar to ventilation on sighing). In the case of neuromuscular diseases, in particular, LIAM can be useful in expanding both thorax and lung. With regular use, there can accordingly be a positive impact on the course of vital capacity.

LIAM can only be enabled by the doctor and only triggered during ventilation. The maneuver includes at least one LIAM stroke consisting of insufflation and subsequent exhalation.

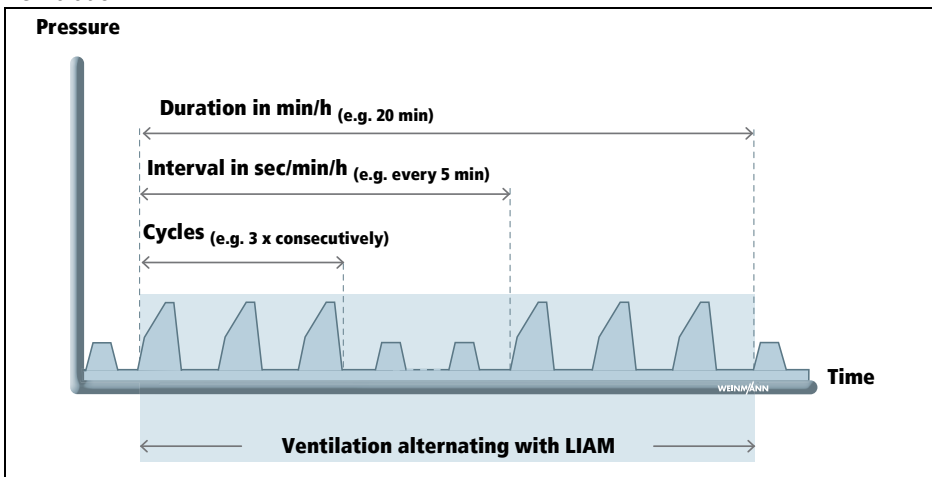

Your doctor uses the **Duration** parameter to specify the period for which LIAM is applied. The **Interval** parameter states at what intervals LIAM will be repeated. Within one interval, either one LIAM stroke (Cycles = 1) or up to 10 consecutive LIAM strokes are executed.

## LIAM to support a coughing maneuver

LIAM can be used to support a coughing maneuver by initially expanding lung and thorax adequately during hyperinsufflation. This makes more air available for the subsequent cough. At the same time, optimized initial tensioning of the lung and thorax increases the effectiveness of the cough on exhalation.

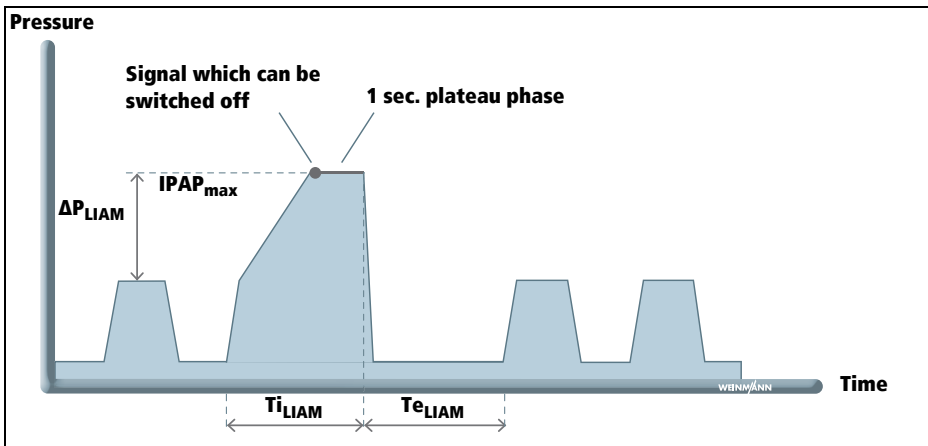

Initially, the pressure curve within the individual LIAM stroke is comparable with a normal ventilation stroke. When the IPAP pressure level is reached, however, pressure continues to rise in linear form to maximum pressure  $IPAP_{max}$  ( $IPAP + \Delta P_{LIAM}$ ) and is maintained for one second (**plateau phase**). The **plateau phase** at the end of insufflation is to facilitate the coordination (closure of the glottis) of a coughing maneuver. The start of the plateau phase is audibly emphasized by an optional **plateau signal**. This plateau signal can be switched on and off in the menu under **LIAM info** (see "5.7.1 Activate/deactivate plateau signal" on page 59). You can also have the following values displayed under **LIAM info**: **Duration, Interval and Cycles**. LIAM ends automatically once the set duration has elapsed or can be cancelled manually (see "5.10.3 Canceling LIAM" on page 62).

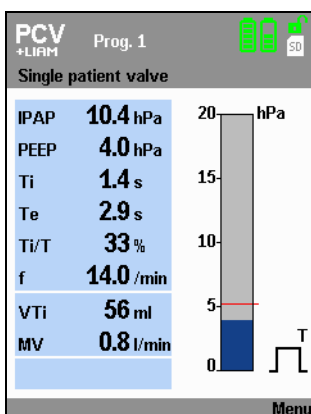

## 5.10.2 Method



You can trigger LIAM manually during ventilation. Press the  key to do so. The device switches to LIAM mode and insufflation is started to synchronize with the next inspiration.

You can perform the whole process yourself several times. Press the  key again to do so.

### 5.10.3 Canceling LIAM

LIAM can be interrupted at any time. Press the  key to do this. Then LIAM is canceled and the device reverts to the preset ventilation mode. If LIAM is then to be carried out again, begin the process by pressing the  key again.

## 5.11 Select a program

---

### Caution!

Ensure that only those ventilation programs which should be accessible for the respective patient are enabled.

If a variety of settings are intended for one patient (mode, parameters, alarms), i.e. ventilated with settings during the day which are different to those during the night, you can select one of the programs configured for the patient in each case.

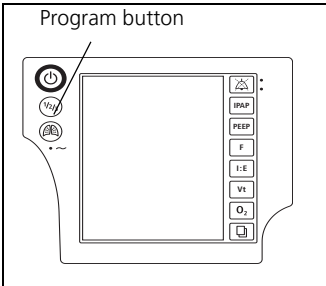

1. Press the program button.

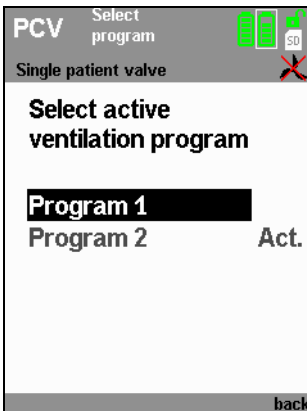

2. Select the desired program and confirm your selection.

Under the menu item **Displays > Summary**, you can view the current settings and alarms of the respectively configured programs as well as the actual values.

## 5.12 After use

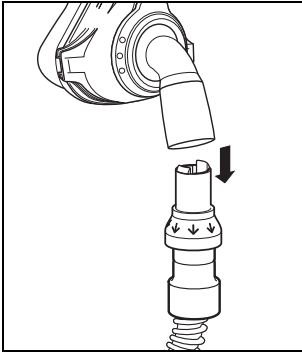

1. Switch the device to standby by keeping the On/Off key depressed for approx. 2 seconds until the blower switches off. The duration of the previous therapy appears in the display. The device then switches to standby.
2. Disconnect the patient/ventilator interface from the patient circuit and the patient circuit from the device.
3. Clean the patient/ventilator interface, patient circuit and device in accordance with the instructions for use. For information on this, see the section entitled "Hygiene treatment" on page 68.

### 5.12.1 Switch device off completely

If the device is connected to a power supply, do not let it be turned off completely. To completely disconnect the device from the power supply, turn the device to standby mode and disconnect the device from the power supply. For optimal battery charging, however, we recommend not to disconnect the device from the power supply.

To switch off the device completely in battery-operated mode, first switch to standby by pressing the On/Off key for about 2 seconds until the blower switches off. Then press the On/Off key again for at least 2 seconds until the device switches off completely and the display goes out.

### 5.12.2 Mobile therapy data check

The therapy device has a memory card reader for SD cards which can be used to save therapy data on a memory card. In discussion with the doctor supervising treatment, this allows the patient's therapy data to be read out independently of the location of the device, as the data can be transported on the memory card.

The following data are stored on the memory card:



- therapy pressure in hPa
- respiratory flow in l/min
- volume, leakage corrected, in ml
- current respiratory phase
- mean leakage flow in l/min
- current ratio Ti/T in %
- current respiratory frequency in 1/min

- ratio of spontaneous inspiration to total number of inspirations in %
- ratio of spontaneous exhalation to total number of exhalations in %
- tidal volume of last inspiration in ml
- mean respiratory minute volume in ml/min
- current physiological alarms
- current technical alarms
- current warnings

This data can be read out from the memory card and displayed with the aid of the VENTiviews software.

If a card is in the device and therapy data is being recorded, a  symbol appears in the status line. If the symbol does not appear, the memory card is defective, absent or not yet recognized by the device.

**Caution!**

Only remove the memory card when data is not being copied onto the card, otherwise therapy data may be lost. End the therapy before removing the memory card. Check whether the  symbol is displayed in the status line. When the  symbol no longer appears in the status line, you can remove the memory card safely.

**Note**

The SD card can only be detected by the device when ventilation mode is running. After inserting the memory card, run the device briefly until the SD card is detected and the symbol  is displayed in the status line.

Proceed as follows to remove the memory card.

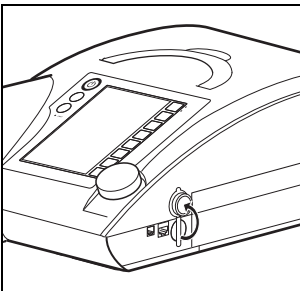

1. The slot for the memory card is located on the side of the device under a rubber cover. Pull on the rubber cover to get at the memory card.
2. To remove the memory card, press briefly on the memory card in the device. A spring mechanism now pushes the memory card out a little way.
3. Remove the memory card.
4. Cover the slot for the memory card again using the rubber cover.



Proceed as follows to put the memory card back in.

1. Pull on the rubber cover to get at the slot for the memory card.
2. Push the memory card into the slot with the cut-off corner pointing upwards.
3. Briefly press on the card so that the card can engage in the device with the aid of the spring mechanism.
4. Cover the slot for the memory card again using the rubber cover.

**Caution!**

When covering the memory card with the rubber cover, take care not to push in the card accidentally, as doing so will eject it from the device. Ejecting the card may cause loss of therapy data.

## 5.13 Travel with the therapy device

---

### **Traveling by air with the VENTI/ogic LS/VENTI/ogic plus:**

The terms of commercial transport do not currently apply to individuals who would like to travel with the therapy device (see "3.1.5 Transport/accessories/spare parts/maintenance" on page 37). The therapy device is currently permitted as checked baggage or hand baggage for travel by plane under the applicable provisions for the carriage of dangerous goods. You may take two spare batteries in hand baggage with the prior consent of the airline company. As these regulations vary depending on the country, method of transport or by changes in regulations, inquire with the airline company before every journey as to which requirements are in place and which measures you must take.

You can obtain a certificate for in flight use and transportation which confirms the electromagnetic compatibility (EMC) from the manufacturer.

### **5.13.1 Bags for the therapy device**

The therapy device has two bags, a protective bag (WM 27106) and a carrying bag for mobile use (WM 27976).

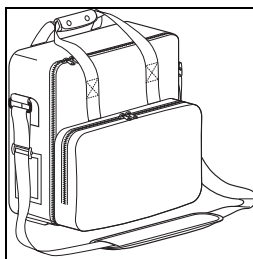

The protective bag WM 27106 is supplied and is for protecting the device but not for mobile operation.

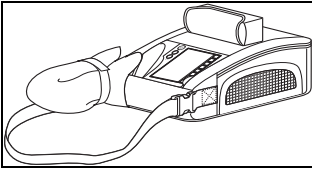

The carrying bag WM 27976 is available as an accessory and allows the device to be operated on a mobile basis.

### 5.13.2 Before starting mobile operation

You should only transport the therapy device any distance in the protective bag WM 27106 intended for it. If you want to use the therapy device on a mobile basis, you must use it in carrying bag WM 27706.

The enclosed straps are for attaching the carrying bag to the back support of a wheelchair. To do this, pull the straps through the loops on the underside of the carrying bag.

Proceed as follows to operate the device on a mobile basis.

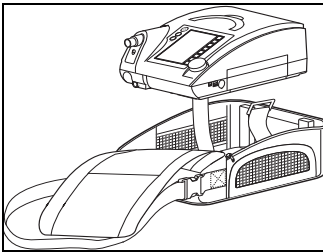

1. Fit the patient circuit and the patient/ventilator interface.
2. Now put the therapy device in the bag. The ventilation tubes must be fed through the tube of fabric in the process.
3. Switch on the therapy device.
4. Secure the therapy device with the hook-and-loop closure in the bag.
5. Close the bag and check that the therapy device is firmly secured in the bag and cannot wobble or fall out.
6. Attach the tube of fabric and the ventilation tubes to the side of the therapy device using the hook-and-loop attachment provided.

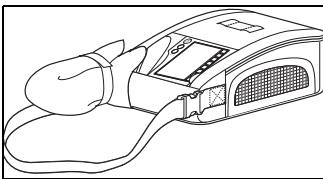

#### Tips for use with a replaceable battery

- If you are using a replaceable battery, you can change it without having to remove the therapy device from the bag. Simply open the hook-and-loop closure on the side of the bag.

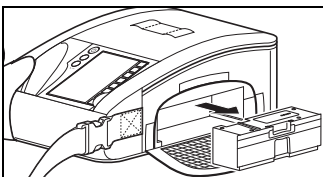

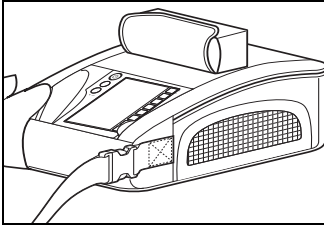

The small accessories bag is provided for a second replaceable battery. You can attach the accessories bag to the front of the carrying bag or to the shoulder strap.

If you charge the batteries in the bag, the device may become so hot under high load that the charging process for the batteries is interrupted.

Only charge the battery outside the bag.

# 6. Hygiene treatment

---

**This product may contain disposable items.** Disposable items are intended to be used only once. So use these items only once and do **not** reprocess them. Reprocessing disposable items may impair the functionality and safety of the product and lead to unforeseeable reactions as a result of ageing, embrittlement, wear, thermal load, the effects of chemical processes, etc.

## 6.1 Intervals

---

You should check the filters at regular intervals and wipe down the housing and the filter compartment lid with a damp cloth. You should also observe the following intervals:

### 6.1.1 Leakage ventilation

Interval	Activity
<b>Daily</b>	<ul style="list-style-type: none"><li>– Clean the patient/ventilator interface in accordance with the relevant instructions for use.</li><li>– Clean the patient circuit.</li><li>– Clean bacteria filter WM 24148 in accordance with the instructions for use.</li><li>– Clean the exhalation system in accordance with the instructions for use every time it is used.</li></ul>
<b>Every 24 operating hours</b>	<ul style="list-style-type: none"><li>– Change the particulate filter in bacteria filter WM 24148.</li></ul>
<b>Weekly</b>	<ul style="list-style-type: none"><li>– Clean coarse dust filter.</li><li>– Clean fan filter.</li></ul>
<b>Every 1000 operating hours</b>	<ul style="list-style-type: none"><li>– Change fine filter (filter change indicator ) , earlier if dirty.</li></ul>
<b>Every 6 months</b>	<ul style="list-style-type: none"><li>– Change coarse dust filter, earlier if dirty or worn.</li><li>– Change pressure measuring tube (see “9.4 Change pressure-measurement tube (only leakage ventilation)” on page 101), earlier if dirty.</li><li>– Change fan filter.</li></ul>
<b>Annually</b>	<ul style="list-style-type: none"><li>– Change patient circuit.</li></ul>

Follow the relevant instructions for use on the hygiene treatment for the patient/ventilator interface.

## 6.1.2 Valve ventilation

Interval	Activity
Daily	<ul style="list-style-type: none"><li>– Clean the humidifier in accordance with the relevant instructions for use.</li><li>– Change bacteria filter WM 27591.</li></ul>
Weekly	<ul style="list-style-type: none"><li>– Clean coarse dust filter.</li><li>– Clean fan filter.</li></ul>
Every 1000 operating hours	<ul style="list-style-type: none"><li>– Change fine filter (filter change indicator ) , earlier if dirty.</li></ul>
Every 6 months	<ul style="list-style-type: none"><li>– Change coarse dust filter, earlier if dirty or worn.</li><li>– Change fan filter.</li></ul>

The patient circuits for single and double patient circuits with patient valve (double patient circuit only on VENTiLogic LS) are disposables and cannot be subjected to a hygiene treatment. Follow the instructions for use for the patient circuit in question.

Follow the relevant instructions for use for the hygiene treatment of the patient/ventilator interface.

## 6.2 Clean leakage ventilation

### 6.2.1 Clean patient circuit

1. Pull the patient circuit off the device and the exhalation system.

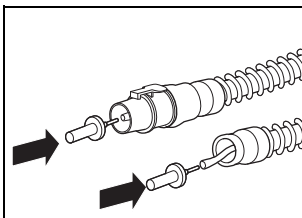

2. Pull out the one end of the pressure measuring tube (shake a little if necessary) and seal it with the sealing plug supplied. At the other end, seal the small opening of the adapter using the second sealing plug so that no water can penetrate.

3. Clean the creased tube with a little detergent in hot water and make sure no residues are left behind. Flush the inside of the tube through thoroughly in the process.

4. Rinse the creased tube thoroughly inside and out using clean hot water.

#### 5. Thoroughly shake out the patient circuit.

6. Hang up the patient circuit and leave to drip-dry well to stop moisture getting into the therapy device.

7. Remove the plugs from the pressure-measurement tube.

## 6.2.2 Dry the patient circuit using the therapy device

If water ever gets into the pressure measuring tube by accident, the leakage circuit must be dried with the aid of the therapy device.

This function can only be activated in standby mode. Likewise press the On/Off key to switch the device to standby.

To start the drying process, proceed as follows.

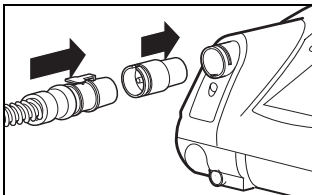

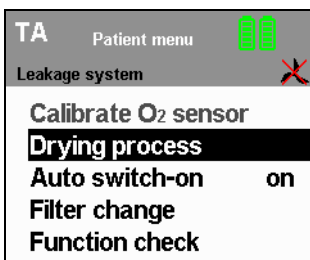

1. Plug the red drying adapter supplied into the device outlet port.
2. Plug the adapter for the patient circuit onto the red drying adapter.

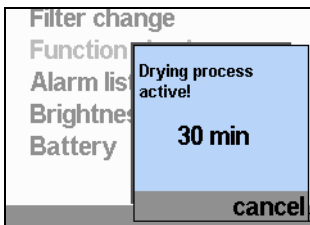

3. Press the menu key  to do so. The patient menu appears in the display.
4. Use the dial to select the menu item **Drying process** and confirm this selection by pressing the dial.

The message **Drying process active! 30 min** appears. This display remains active throughout the entire drying process and indicates remaining drying time. After the drying process is complete, the device switches off.



5. If you want to interrupt the drying process, press the menu key  (**cancel**). The display switches back to the default display, the device switches back to standby.

If the patient circuit still has damp places after drying, start the drying process again.

6. Remove the drying adapter from the device outlet port.

## 6.3 Clean the housing

---



### Warning!

- Risk of electric shock. Switch the device off completely before cleaning (see “Switch device off completely” on page 63).
- Ensure that no liquids get into the device. Never immerse the device in disinfectants or other liquids, otherwise damage to the device and thus a hazard to users and patients may result.

Proceed as follows to clean the housing.

1. Wipe down the device and the power cord with a soft damp cloth. The therapy device must be completely dry before the device is started up.

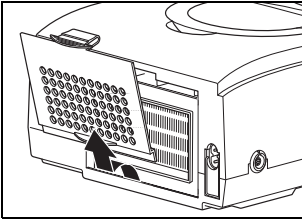

2. Take off the filter compartment lid.
  3. Remove the coarse dust filter as described in “9.3 Change filter”.
  4. Clean the filter compartment lid under running water until there are no residues. Then dry it carefully.
  5. Insert the coarse dust filter and the filter compartment lid as described in “9.3 Change filter” on page 98.
6. Remove the fan filter on the front of the device and clean it as described in “9.3 Change filter”.
  7. Put the fan filter back in.

## 6.4 Clean coarse dust filter/change fine filter

---

1. Take off the filter compartment lid as described in “9.3 Change filter”.
2. Remove the coarse dust filter from out of the filter compartment lid and clean it with clean running water until there are no residues.
3. Change the fine filter if required.
4. Allow the coarse dust filter to dry. The coarse dust filter must be completely dry before the device is started up.
5. Put the coarse dust filter back in and close the filter compartment lid.

### Note:

The fine filter cannot be cleaned. It is changed every 1000 operating hours.

## 6.5 Clean the fan filter

---

The fan filter protects the housing fan from dirt.

To clean the fan filter, proceed as follows:

1. Remove the fan filter according to the instructions in section "Change fan filter" on page 100.
2. Clean the fan filter with fresh running water until it is free of residue.
3. Let the fan filter dry. The fan filter must be completely dry before starting the device.
4. Insert the fan filter again according to the instructions in section "Change fan filter" on page 100.

## 6.6 Clean the accessories

---

To clean the accessories, see the section entitled "Hygiene treatment" in the corresponding instructions for use.

## 6.7 Clean the SpO<sub>2</sub> module

---

The housing of the SpO<sub>2</sub> *module* should be cleaned at regular intervals depending on contamination.

Wipe the SpO<sub>2</sub> *module* and the connecting cable with a soft damp cloth.

## 6.8 Disinfect, sterilize

---

If required, e.g. following infectious diseases or unusual contamination, you can also disinfect the housing, the power cord, the patient circuit (leakage ventilation only) and the bacteria filter housing (leakage ventilation only). See the instructions for use for the disinfectant used. We recommend wearing suitable gloves (e.g. household or disposable gloves) for disinfecting.

### 6.8.1 Device

The housing and the power cord of the therapy device are cleaned simply by wiping with disinfectant. We recommend terralin® protect for this purpose.



## 6.8.2 Patient circuit (leakage ventilation)

We recommend GIGASEPT FF as disinfectant. When using GIGASEPT FF, take the same steps as described under “6.2 Clean leakage ventilation”.

Rinse all parts thoroughly in distilled water following disinfecting. Allow the parts to dry completely.

Allow the patient circuit to drip dry. Dry the patient circuit with the therapy device as described in section 6.2 on page 69.

- Creased hose WM 24130 (transparent) can be washed in water at temperatures of up to 70 °C. It may not be sterilized.
- Creased tube WM 24120 (gray) can be steam-sterilized with devices to EN 285. Temperature: 134 °C, minimum retention time 3 minutes. Follow EN 554/ISO 11134 with regard to validation and monitoring.

## 6.8.3 Patient circuit (valve ventilation)

Patient circuits with patient valve are not suitable for reuse. Follow the enclosed instructions for use in this regard.

## 6.8.4 Oxygen sensor

The housing of the oxygen sensor is cleaned by wiping with disinfectant. No further cleaning or hygiene treatment is possible. If the oxygen sensor has been used without a bacteria filter before a change of patient, it must be replaced.

## 6.8.5 Accessories

To disinfect/sterilize the accessories, see the section entitled “Hygiene treatment” in the corresponding instructions for use.

## 6.8.6 SpO<sub>2</sub> module

Sterilization of the SpO<sub>2</sub> module is not permitted.

If required, e.g. following infectious diseases or unusual contamination, you can also disinfect the housing of the SpO<sub>2</sub> module and the connecting cable. We recommend terralin<sup>®</sup> protect for this purpose. See also the instructions for use for the disinfectant used. We recommend using suitable gloves (e.g. household or disposable gloves) when disinfecting.

## 6.9 Change in patients

---

If the device is operated **with** a bacteria filter, observe the following.

- Change bacteria filter WM 27591

or:

- sterilize bacteria filter WM 24148 and change the particulate filter inside it.

If the device is to be used for another patient **without** a bacteria filter being used, it must be subjected to a hygiene treatment beforehand. This must be performed by the manufacturer or by an authorized specialist dealer.

The procedure for hygiene treatment is described in the service sheet and in the servicing and repair instructions for the therapy devices.

# 7. Function check

## 7.1 Intervals

Perform a function check of the device monthly. One exception to this is the oxygen sensor.

The oxygen sensor needs calibrating daily.

We recommend checking the battery capacity before each use.

If you discover faults during the function check, you may not use the therapy device again until the faults have been rectified.

## 7.2 Method

1. Assemble the therapy device so that it is ready to function.
2. Seal the opening of the patient circuit, e.g. with a sealing plug. For hygiene reasons, suitable disposable gloves should be worn if you seal the opening of the patient circuit with your thumb or hand.
3. Switch on the device by pressing the On/Off key . If the device works perfectly, two different acoustic signals should sound after switching on and both LEDs next to the alarm acknowledgement key should come on.

Depending on the operating mode set, now test the following functions:

<b>Mode Function</b>	<b>S</b>	<b>T</b>	<b>ST</b>	<b>CPAP</b>	<b>PCV</b>	<b>aPCV</b>	<b>PSV</b>	<b>VCV*</b>	<b>aVCV*</b>	<b>SIMV</b>	<b>MPVv</b>	<b>MPVp</b>
<b>Triggering</b>	•	-	•	-	-	•	•	-	•	•	•	•
<b>Flow sensor/ pressure sensor</b>	•	•	•	•	•	•	•	•	•	•	•	•
<b>Alarms</b>	•	•	•	•	•	•	•	•	•	•	•	•
<b>Oxygen supply</b>	•	•	•	•	•	•	•	•	•	•	-	-

If the values/functions quoted below are not met, send the device to your specialist dealer or to the manufacturer for repair.

\* These modes are only available with VENTI/logic LS.

## 7.2.1 Check flow measurement and flow sensors/pressure sensors (leakage ventilation)

### Note:

A function check of the flow sensors/pressure sensors can only be carried out in standby mode.

1. Plug the red drying adapter supplied into the device outlet port.
2. **For hospital staff only:** Ensure that the patient circuit set on the device is the same as the patient circuit actually in use.
3. Press the menu key  to access patient mode.

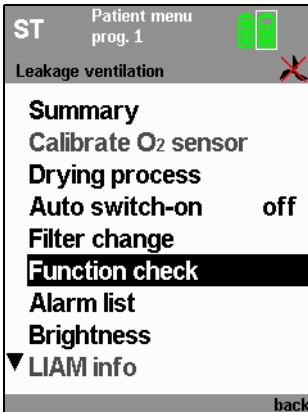

4. Use the dial to move the black selection bar to **Function check** and press **ENTER**.
5. Confirm the function check in the following window. The message window **Function check running!** opens. The remaining duration of the function check is displayed.

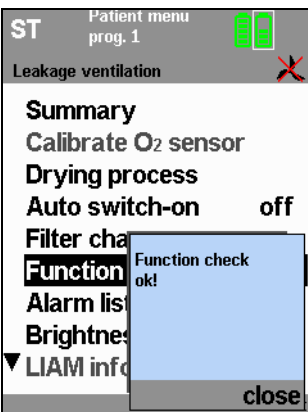

6. If the function check is completed successfully, the message **Function check ok!** appears. If the function check is not successful, the message **Device system implausible** appears. In this case refer to section "8.1 Faults" on page 82.
7. Press the menu key to return to the standard display.

## 7.2.2 Check flow measurement and flow sensors/pressure sensors (leakage ventilation with leakage adapter for standard tapered connector)

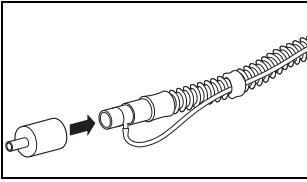

1. Connect the patient circuit to the device.
2. Plug the test adapter supplied onto the patient connection.
3. Perform the subsequent steps as described in “7.2.1 Check flow measurement and flow sensors/pressure sensors (leakage ventilation)” **from step 2**.

## 7.2.3 Check flow measurement and flow sensors/pressure sensors (valve ventilation)

### Function check using a single patient circuit with patient valve

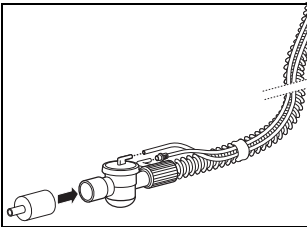

1. Connect the patient circuit to the device.
2. Plug the test adapter supplied onto the patient connection.
3. The subsequent steps are described in “7.2.1 Check flow measurement and flow sensors/pressure sensors (leakage ventilation)” **starting from step 2**.

### Function check using a double patient circuit with patient valve (VENTI/ogic LS only)

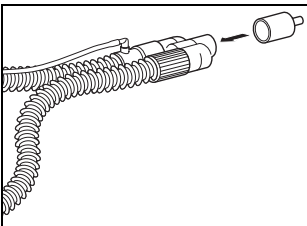

1. Connect the patient circuit to the device.
2. Plug the test adapter supplied onto the patient connection.
3. The subsequent steps are described in “7.2.1 Check flow measurement and flow sensors/pressure sensors (leakage ventilation)” **starting from step 2**.

## 7.2.4 Alarms

The therapy device performs a self-test on the sensor system when the On/Off key  is pressed which also checks that the alarm system is working. If a fault occurs during the self-test, an error message appears in the main screen (see also “8. Troubleshooting” on page 82).

1. Check buzzer and LEDs:

Ensure each time you switch on that two different acoustic signals sound one after the other and that the yellow and red LEDs come on at the same time.

2. Check the **No power supply** alarm (power supply failure alarm):

Start up the therapy device. Now take the power cord out of the socket. The internal battery assumes power supply, the two buzzers sound and the yellow LED comes on. The low-priority alarm window **No power supply** appears. Plug the power cord into the power socket again. The alarm should no longer be displayed.

## 7.2.5 Oxygen supply

### **Caution!**

If a compressed gas system is used instead of an oxygen concentrator, an overpressure valve must be fitted.

### **Note:**

A function check can only be performed on the oxygen supply if the oxygen supply has been activated by the doctor beforehand (flow meter or oxygen concentrator).

In order to carry out a function check on the oxygen supply, proceed as follows:

1. Start up the therapy device.
2. Connect the oxygen source to the therapy device and start it up.
3. At the oxygen source, set the oxygen flow to the value prescribed by the doctor.
4. Select one of the following procedures depending on whether or not you are using an oxygen sensor.

### **With an oxygen sensor**

Ensure that the oxygen sensor is connected correctly and has been calibrated beforehand. The oxygen supply is functioning properly if an oxygen concentration of > 21 % is shown on the display and the oxygen flow rate prescribed can be set on the oxygen source.

### **Without oxygen sensor**

The oxygen supply is functioning properly if the oxygen flow rate prescribed can be set on the oxygen source.

## 7.3 Calibrate oxygen sensor (only valve ventilation)

---

### 7.3.1 General

If oxygen is supplied during therapy, oxygen concentration is measured at the device outlet port so as to ensure that the patient is always adequately supplied with oxygen.

To ensure the accuracy of the measurement, calibration should be performed daily.

Calibration is necessary in the case of

- unsettled weather (air pressure, temperature) or
- changes in therapy pressure.

Always perform calibration with the device warmed up (approx. 20 minutes after switching on).

Perform calibration of the oxygen sensor once a day to avoid the weather affecting measuring results. The device will issue the relevant message each day to remind you to perform calibration. This message also appears if:

- the device has previously been disconnected from the power supply
- 24 hours have passed since the last calibration
- the oxygen sensor has been disconnected electrically from the device and then reconnected.

#### **Note**

**The sensor is calibrated at a proportion of 21 % oxygen (ambient air). Turn off the oxygen supply on the oxygen source (flow meter or oxygen concentrator) for this.**

### 7.3.2 Precautions

Take the following precautions when calibrating.

1. Shut off the oxygen source.
2. Operate the device for approx. two minutes without an oxygen supply to flush out the remaining oxygen in the device.

### 7.3.3 Perform calibration

Proceed as follows for calibration.

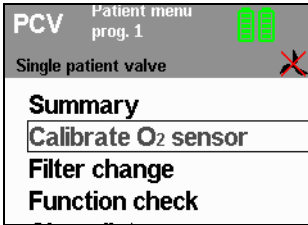

1. Ensure that the oxygen sensor is connected.
2. Operate the device.
3. Press the O<sub>2</sub> key or the menu key . The selection bar is on **Calibrate O<sub>2</sub> sensor**.
4. Confirm your selection by pressing the dial. Remaining calibration time is displayed. The device then automatically switches back to the patient menu.
5. Check the display: the oxygen sensor is working perfectly if mean oxygen concentration is 21 %.

### 7.3.4 Shelf life of the oxygen sensor

The shelf life of the oxygen sensor depends on the concentration of the oxygen supplied, on ambient temperature, on duration of use and on the device settings. Under normal conditions (ambient temperature 21 °C, 40 % oxygen concentration) the sensor lasts 6 months.

**Note:**

The sensor becomes exhausted even if it is not connected.

### 7.3.5 Change oxygen sensor

Once the oxygen sensor is exhausted, remove it from the device. Connect a new oxygen sensor as described in “Measure oxygen concentration (only valve ventilation)” on page 47.

**Note:**

Depending on storage time and temperature, the sensor requires a little time for measured values to stabilize. As a result, after unpacking from the original packaging and connecting the sensor, you should wait about 30 minutes before calibrating the new sensor.



## 7.4 Energy supply

---

### 7.4.1 Power supply

Connect the device to the power supply.

The power supply is working perfectly if the green power supply LED comes on permanently and the standby screen appears in the display.

### 7.4.2 Internal battery and energy failure alarm

1. If present: remove the replaceable battery (see "5.5 Alarm list" on page 57).
2. For the procedure for the function check of the power supply failure alarm, see the chapter entitled "Alarms" on page 77.

If supply is not assumed by the battery without interruption, either this or the therapy device is defective. In this case have the device including its internal battery checked by an authorized specialist dealer or by the manufacturer.

3. Check battery capacity (shown in the status line of the display).

If fewer than three segments are displayed in the battery symbol, the battery is not fully charged. In this case, charge the battery by connecting the device to the power supply.

### 7.4.3 Replaceable battery (if present)

1. Push the replaceable battery into the device until you hear the latch engage.

The symbol for the replaceable battery appears on the right next to the internal battery in the status line and a beep sounds.

2. Check battery capacity (shown in the status line of the display):

If fewer than three segments are displayed in the battery symbol, the battery is not fully charged. In this case, charge the battery by connecting the device to the electricity supply.



Replaceable batteries which have been stored for over a month must be charged up before they are used to guarantee an accurate display.

# 8. Troubleshooting

## 8.1 Faults

### Caution!

If you are unable to remedy faults with the aid of the table, or in the event of unexpected operation or an incident, contact the manufacturer or your authorized specialist dealer. To avoid exacerbating the damage, do not continue operating the device.

Fault/fault message	Cause of fault	Remedy
Device cannot be switched on (battery operation)	Transport securing device for battery is active.	The battery fitted is deactivated for transport purposes. Before using for the first time, connect power supply and charge battery.
Device cannot be switched on by taking a breath	Auto switch-on not activated	Activate Auto switch-on (only leakage ventilation) (5.4, Page 56)
	Valve ventilation connected	
Filter change	Filter dirty	Press alarm acknowledgement key, clean/change filter as soon as possible (6.4, Page 71)
Filter change indicator  appears		Clean/change filter as soon as possible (6.4, Page 71)
Battery discharged	Internal battery of device exhausted	Press alarm acknowledgement key, have battery replaced by a specialist dealer so that course of therapy is recorded correctly
Clock not set	Internal clock not set	Press alarm acknowledgement key, have clock set by a specialist dealer so that course of therapy is recorded correctly
Arrange maintenance	Maintenance interval expired	The device needs to be checked or serviced by a specialist dealer as soon as possible
Service indicator  appears		

<b>Fault/fault message</b>	<b>Cause of fault</b>	<b>Remedy</b>
Calibrate O <sub>2</sub> sensor	Initial contact with oxygen sensor	Perform calibration of oxygen sensor
	Oxygen supply has not been turned off	
	Last calibration performed over 24 hours ago	
	Device was switched off completely beforehand	
Blower failure	Blower no longer working	Have device repaired
Internal batt. not charging due to overtemperature	Battery too hot	Protect device from direct sunlight, do not operate near a radiator
Internal batt. not charging due to overtemperature	Battery too cold	Ensure that the device is operated within the permitted temperature range
Replaceable battery not detected	Battery defective	Have device repaired
	Non-approved battery in use	Use genuine battery
	Using the WM 27998 battery with a firmware version < 2.9.0	Update the firmware to version 2.9.0 or above
Replaceable battery is hard to push in or jams	Particles of dust in guide rails	Clean guide rails on replaceable battery and lower part of housing
Service life ended. Have replaceable battery replaced.	The replaceable battery has reached the end of its service life.	Replace the replaceable battery.
Service life ended. Have internal battery replaced.	The internal battery has reached the end of its service life.	Replace the internal battery.
Device cannot be switched on (battery operation)	Transport securing device for battery is active.	The battery fitted is deactivated for transport purposes. Before using for the first time, connect the power supply and charge battery.
SpO <sub>2</sub> measurement disconnection	SpO <sub>2</sub> sensor has slipped out of place or come loose from the fingertip	Attach the SpO <sub>2</sub> sensor to the fingertip properly



Fault/fault message	Cause of fault	Remedy
SpO <sub>2</sub> signal weak	Nail varnish, dirty fingers	Check SpO <sub>2</sub> sensor and fingertip and clean if need be
	Patient shock	Check patient condition

## 8.2 Alarms

A distinction is made between two kinds of alarm.

- **Physiological alarms** are those alarms which affect the patient's ventilation directly.
- **Technical alarms** are those alarms which affect the configuration of the device.

The alarms are classified into three priorities:

- low-priority alarms, indicated by the symbol  in the alarm window, a **continuously illuminated** yellow LED and an acoustic alarm issued (buzzer)
- medium-priority alarms, indicated by the symbol  in the alarm window, a **flashing** yellow LED and an acoustic alarm issued (buzzer)
- high-priority alarms, indicated by the symbol  in the alarm window, a **flashing** red LED and an acoustic alarm issued (buzzer)

### 8.2.1 Deactivate alarms

The doctor supervising treatment can decide which physiological alarms to activate or deactivate. If the symbol  appears in the status line, all the physiological alarms have been deactivated by the supervising doctor (see "Physiological alarms" on page 85).

### 8.2.2 Acknowledging alarms

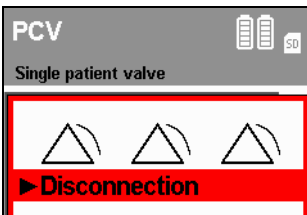

If a fault triggers an alarm (in this case: disconnection alarm), you can have the acoustic alarm paused for about 120 seconds by pressing the alarm acknowledgement key .

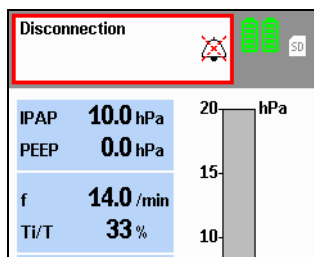



The default display appears again after the acoustic alarm has been acknowledged. The fault which has not yet been rectified continues to be displayed in the status line and the alarm LED flashes (or stays on) until the fault is rectified.

If the fault is not rectified within 120 seconds of the acknowledgement, the acoustic alarm (buzzer) sounds again.

You can find troubleshooting assistance in the following tables.

### 8.2.3 Sequence of displays if alarms are triggered simultaneously



If several alarms are triggered simultaneously, they are displayed in accordance with the hierarchy shown below.





-  1.High-priority alarms
-  2.Medium-priority alarms
-  3.Low-priority alarms







If a new alarm with a higher priority occurs after one alarm is displayed, the alarm display switches to the higher priority. The low-priority alarm is retained and is displayed again once the high-priority alarm has been eliminated if it still applies.

### 8.2.4 Physiological alarms



Display	Alarm	Cause of fault	Remedy
IPAP <sub>low</sub>  (pressure-controlled only)	Minimum therapy pressure undershot. Medium priority	Filter dirty	Clean/change filter
		Patient/ventilator interface leaking	Adjust headgear/headband so that the patient/ventilator interface seals, possibly replace it
		Patient/ventilator interface defective	Replace patient/ventilator interface
		Settings implausible	Have the settings checked by the doctor supervising treatment

Display	Alarm	Cause of fault	Remedy
$VT_{low}$ 	Minimum respiratory volume undershot. High priority	Filter dirty	Clean/change filter
		Patient/ventilator interface leaking	Adjust headgear/headband so that the patient/ventilator interface seals, possibly replace it
		Patient/ventilator interface defective	Replace patient/ventilator interface
		Settings implausible	Have the settings checked by the doctor supervising treatment
		In MPVv mode: minimum volume is not reached within the specified time	Have the settings checked by the doctor supervising treatment
$VT_{high}$ 	Maximum tidal volume exceeded. High priority	Leak in the single patient circuit (only with patient circuit with patient valve)	Find and eliminate leak, replace patient circuit if required
		Patient breathing as well	Have settings checked by the doctor supervising treatment
$O_2_{high}$ 	Maximum oxygen concentration exceeded at device outlet port. Medium priority	Oxygen supply too high as a result of oxygen flow rate being incorrectly set	Check whether the oxygen flow rate prescribed by the doctor is set correctly at the oxygen source. Have settings checked by the doctor supervising treatment if appropriate
		Oxygen sensor incorrectly calibrated	Calibrate oxygen sensor

Display	Alarm	Cause of fault	Remedy
<p>O<sub>2</sub> low</p> 	<p>Minimum oxygen concentration undershot at device outlet port. Medium priority</p>	Oxygen flow rate set too low	Check whether the oxygen flow rate prescribed by the doctor is set correctly at the oxygen source. Have settings checked by the doctor supervising treatment if appropriate
		Leak	Find and eliminate leak
		Oxygen supply interrupted	Check oxygen supply and connections
		Oxygen sensor incorrectly calibrated	Calibrate oxygen sensor
<p>SpO<sub>2</sub> low</p> 	<p>Patient's oxygen saturation levels have fallen below the minimum limit.</p>	Ventilator interface faulty or defective	Check ventilator interface and replace if necessary
		Oxygen supply faulty or inadequate	Check oxygen supply and correct if necessary
		Ventilation parameter settings (pressure, volume, frequency, I:E) not suitable	Check ventilation parameter settings and adjust if need be
		Alarm settings implausible	Check alarm settings and correct if necessary
<p>SpO<sub>2</sub> high</p> 	<p>Maximum alarm setting of patient's oxygen saturation exceeded</p>	Settings implausible	Check settings and correct if necessary
<p>Pulse low</p> 	<p>Patient's pulse rate fallen below the minimum limit</p>	Therapeutic or pathophysiological causes	Check treatment and patient state
		Alarm settings implausible	Check alarm settings and correct if necessary

Display	Alarm	Cause of fault	Remedy
Pulse high 	Patient's maximum pulse rate exceeded	Ventilation parameter settings (pressure, volume, frequency, I:E) not suitable	Check ventilation parameter setting (pressure, volume, frequency, I:E) and adjust if need be
		Therapeutic or pathophysiological causes	Therapeutic or pathophysiological causes
		Alarm settings implausible	Check alarm settings and correct if necessary
Frequency <i>low</i> * 	Minimum respiratory frequency undershot. Low priority	Apnea in spontaneous breathing mode	Have settings checked by the doctor supervising treatment
Frequency <i>high</i> * 	Maximum respiratory frequency exceeded. Low priority	Patient hyperventilating	Calm patient and move towards a "normal" respiratory frequency. Call a doctor
Pressure <i>high</i> Volume is not reached. (VENTI <i>logic</i> LS only) 	Maximum pressure exceeded. Low priority, after 10 breaths, rises to medium priority	Various possible causes, e.g. reduction in lung impedance	Have settings checked by the doctor supervising treatment
Pressure <i>low</i> (VENTI <i>logic</i> LS only) 	Minimum therapy pressure undershot. Medium priority	Filter dirty	Clean/change filter
		Patient/ventilator interface leaking	Adjust headgear/headband so that the patient/ventilator interface seals, possibly replace it
		Patient/ventilator interface defective	Replace patient/ventilator interface
		Settings implausible	Have settings checked by the doctor supervising treatment
Minute volume <i>low</i> * 	High priority	Minimum minute volume undershot	Have the settings checked by the doctor supervising treatment
Minute volume <i>high</i> * 	Medium priority	Maximum minute volume exceeded	Have the settings checked by the doctor supervising treatment





Display	Alarm	Cause of fault	Remedy
Apnea 	Low priority	No spontaneous breathing for at least 3 breaths	Have the settings checked by the doctor supervising treatment
Apnea  (Only in MPVv and MPVp modes)	High priority	No spontaneous breathing within set time	Have the settings checked by the doctor supervising treatment
Leakage  (Only available in dual leakage ventilation system)	Medium priority	Leakage	Find and eliminate leak, replace patient circuit if necessary









\* These alarms are only activated 2 minutes after ventilation starts.







## 8.2.5 Technical alarms



### Caution!







If you are unable to remedy faults with the aid of the table, or in the event of unexpected operation or an incident, contact the manufacturer or your authorized specialist dealer. To avoid exacerbating the damage, do not continue operating the device.









Display	Alarm	Cause of fault	Remedy
Battery capacity critical 	Medium priority	Battery discharged (under 25 % capacity remaining)	Restore power supply and charge battery. In the event of an extended power outage, keep an alternative ventilation option to hand or use a replaceable battery.
Battery capacity highly critical 	High priority	Battery discharged (under 10 % capacity remaining)	Restore power supply and charge battery. In the event of a power outage, keep an alternative ventilation option to hand or use a replaceable battery.

<b>Display</b>	<b>Alarm</b>	<b>Cause of fault</b>	<b>Remedy</b>
Internal battery defective 	High priority	Device defective	Have device repaired
		Battery defective	
Internal battery not detected 	Low priority	Battery defective	Have device repaired.
		An unapproved battery is being used	
Using the WM 27998 battery with a firmware version < 2.9.0	Update the firmware to version 2.9.0 or above		
Have replaceable batt maintained 	High priority	Capacity value of replaceable battery implausible	Maintain replaceable battery (9.2.1, Page 97) or replace replaceable battery.
Have internal batt maintained 	High priority	Capacity value of internal battery implausible	Maintain internal battery (9.2.1, Page 97) or have internal battery replaced.
Battery temp. critical 	High priority	Battery too hot	Allow device to cool down, find a more suitable location to set it up. Use alternative ventilation option
Internal batt. off due to temperature 	High priority	Battery too hot	Allow device to cool down, find a more suitable location to set it up. Use alternative ventilation option
Replaceable battery defective 	High priority	Device defective	Have device repaired
	High priority	Battery defective	
Replacement batt. off due to temperature 	High priority	Battery too hot	Allow device to cool down, find a more suitable location to set it up. Use alternative ventilation option

<b>Display</b>	<b>Alarm</b>	<b>Cause of fault</b>	<b>Remedy</b>
Fault in power supply Change device 	High priority	Device defective	Have device repaired. Use alternative ventilation option
O <sub>2</sub> measurement defective 	Medium priority	Disconnected, exhausted or defective sensor	Check oxygen sensor and replace if necessary
SpO <sub>2</sub> measurement defective 	Medium priority	SpO <sub>2</sub> sensor defective or slipped out of place	Check SpO <sub>2</sub> sensor and, if need be, have it changed or attach SpO <sub>2</sub> sensor to the fingertip properly.
		Disruptions from other light sources	Avoid exposure to light from other light sources.
O <sub>2</sub> valve failure 	Medium priority	Safety valve defective, no oxygen supply possible	Have device repaired
Excessive pressure 	High priority	Pressure sensor defective	Have device repaired
Disconnection 	High priority	Patient circuit is incorrectly connected to the device or not connected at all	Check tube system
		Device being operated with patient/ventilator interface open (not put on)	Put on patient/ventilator interface or switch off device
Excessive temperature 	High priority	– Device has overheated, for example as a result of direct sunlight or other radiated heat	Allow device to cool down, find a more suitable setup location. Use alternative ventilation option
	Medium priority	– Device operated outside permitted temperature range	Allow device to cool down, choose more suitable setup location. Keep alternative ventilation option to hand

Display	Alarm	Cause of fault	Remedy
Display gone out	Acoustic signal for at least 120 seconds, no display. High priority	No power supply and internal battery is discharged	Check power cord is firmly connected. If necessary, check the function of the socket by connecting a different device (e.g. a lamp). Connect device to a power socket and charge internal battery
		Device defective	Have device repaired
Fault in tube system 	Medium priority	Exhalation tube not connected	Check tube system and replace patient circuit if required
		Incorrect patient circuit connected	
		The patient circuit selected in the menu does not correspond to the patient circuit connected	Change patient circuit or have settings corrected by physician supervising treatment
		Device defective	Have device repaired
Control pressure <sup>high</sup> 	High priority	The patient circuit selected in the menu does not correspond to the patient circuit connected	Change patient circuit or have settings corrected by doctor supervising treatment
		Valve control tube and pressure measuring tube the wrong way round	Check tube system
Control pressure <sup>low</sup> 	High priority	The valve control tube between the device and the patient valve is incorrectly connected	Check valve control tube for damage, replace patient circuit if necessary Connect valve control tube
		Valve control tube and pressure measuring tube the wrong way round	Check tube system
		The patient circuit selected in the menu does not correspond to the patient circuit connected.	Change the patient circuit or have settings corrected by doctor supervising treatment

Display	Alarm	Cause of fault	Remedy
Pressure permanently low 	High priority	The valve control tube between the device and the patient valve is incorrectly connected	Check valve control tube for damage, replace patient circuit if necessary Connect valve control tube
		Device defective	Have device repaired
		Implausible ventilation settings	Have settings checked by the doctor supervising treatment
		Permanent large leak	Check patient circuit and patient/ventilator interfaces and change if necessary
		Filter dirty	Clean/change filter
VT permanently low 	High priority	Permanent large leak	Check patient circuit and patient/ventilator interfaces and change if necessary
		Device defective	Have device repaired
EPAP high 	High priority	The pressure drop on exhalation is inadequate (possible cause: pressure drop at patient valve too slow)	Ensure that the exhaled air can escape freely at the patient valve Check tube system
Continuous pressure 	High priority	Device defective	Disconnect device from power supply and switch off. Check connections for tubes. Restore power connection and perform function check. If the fault continues to occur, have device repaired
Control voltage failure 	Medium priority	RS485 incorrectly connected	Only use converter cable USB-RS485 WM 93318 or converter box WM 93316
		Internal fault	Have device repaired
Device start error 	High priority	Parameters could not be loaded	Have device repaired
	High priority Device switches off.	Blower does not switch back on after power failure	

Display	Alarm	Cause of fault	Remedy
IPC failure Change device 	High priority Device switches off.	Device defective	Have device repaired
Sensor system failure Change device 	High priority Device switches off.	Sensor system defective	Have device repaired
System monitoring failure 	Low priority	Voltage monitoring failure	Have device repaired
No power supply 	Low priority	Power supply failed	Keep alternative ventilation option to hand. Check power cord is firmly connected. If necessary, check the function of the socket by connecting a different device (e.g. a lamp)
Blower failure Change device 	High priority Device switches off.	Device defective	Have device repaired
CPU failure Change device 	High priority Device switches off.	Internal processing faulty, device defective	Have device repaired
I <sup>2</sup> C failure 	Medium priority	Device defective	Have device repaired
Warning: Device switched off! 	High priority	Device has been switched off	Turn the device on again
			Acknowledge alarm
Unknown device 	High priority	Device defective	Have device repaired

## 8.2.6 Storage of alarms

Once the alarm threshold is reached, all the alarm types listed in tables “8.2.4 Physiological alarms” and “8.2.5 Technical alarms” are recorded in an alarm list with date, time and duration. Up to 200 alarms can be stored. After that, the oldest alarm in each case is overwritten. The alarm list can be called up by the doctor supervising treatment or by you (see “5.5 Alarm list” on page 57).

The alarm list is retained even if the entire power supply (power supply and internal battery) fails. In this case, the data can be called up for up to two years. The alarm list is deleted after two years or when maintenance is carried out.

In any event, alarms are retained in the event of a power failure.

## 8.2.7 Passing on of alarms via the remote alarm connection

All high and medium-priority alarms are switched to a remote alarm connection in parallel. The only low-priority alarm which is passed on to the connection is the **No power supply** alarm.

If the device is operated in a hospital, the therapy device can be connected to the hospital’s nurse call system via the remote alarm connection.

For home ventilation, the therapy device can also be connected to the VENTI*remote alarm* box via the remote alarm connection. The remote alarm box remotely transmits and amplifies the acoustic and visual alarm signals output by the therapy device. It is of particular assistance to nursing staff and to relatives when looking after the patient in the home environment.

# 9. Maintenance and safety checks

---

The device is designed for a service life of 6 years.

If used in accordance with the intended use, the device requires no servicing during this period.

If the device is used beyond this period, it needs checking by an authorized specialist dealer.

For Germany: In accordance with §11 of the German law governing the owners/operators of medical devices [Medizinprodukte-Betreiberverordnung], the device must be subjected to a Technical Safety Check [Sicherheitstechnische Kontrolle (STK)] every 2 years.

## 9.1 Intervals

---

**We recommend having servicing, safety checks and repair work carried out only by the manufacturer or by a specialized dealer expressly authorized by the manufacturer.**

Check both filters regularly for dirt.

- The coarse dust filter and the fan filter should be cleaned once a week and changed no later than every 6 months.
- The fine filter must be changed after no more than 1000 operating hours (filter change symbol  appears in the display).

For hygiene reasons, we recommend replacing the following parts at the intervals specified.

### 9.1.1 Leakage ventilation

- Pressure measuring tube every 6 months - earlier if dirty.
- Clean the patient/ventilator interface in accordance with the relevant instructions for use.
- Clean the exhalation system in accordance with the relevant instructions for use.
- If necessary, other accessories in accordance with the associated operating instructions.



### 9.1.2 Valve ventilation

- The patient circuits with patient valve should be replaced in accordance with the relevant instructions for use.
- Clean the patient/ventilator interface in accordance with the associated instructions for use.
- If necessary, other accessories in accordance with the associated instructions for use.

### 9.1.3 Internal battery

- Have the internal battery replaced by the manufacturer or an authorized specialist dealer at least every 2 years.

### 9.1.4 Replaceable battery (if present)

- Have the replaceable battery checked by the manufacturer or an authorized specialist dealer after 2 years.
- Replace the replaceable battery after no more than 4 years.

## 9.2 Batteries

---

The internal battery and the replaceable battery (if present) are maintenance-free.

### 9.2.1 Care of batteries

#### **Warning!**

An alternative ventilation option (e.g. a replacement device or manual ventilating bag) must be used during maintenance of the internal battery for patients dependent on a ventilation device. The internal battery may not be maintained with patient ventilation in progress.

To prolong the life of your batteries, we recommend the measures below:

- Run down the battery completely every 6 to 12 months by running the device without a power cable using the red test adapter until the device switches to the internal battery/switches off and then recharge the battery completely. This increases the accuracy of the capacity display. You should also observe the maintenance intervals for the internal battery (see "9.1.3 Internal battery" on page 97) and the replaceable battery (see "9.1.4 Replaceable battery (if present)" on page 97).

**Note**

When the device is being operated with the red test adapter, alarms may occur as a function of device settings (see “8.2 Alarms” on page 84).

## 9.2.2 Storage

### Internal battery

If the device is to be operational at all times, we recommend leaving the device connected to the power supply even if it is not used for prolonged periods. This ensures that the battery is always fully charged.

### Replaceable battery (if present)

If storing the battery for more than a week, store it separately from the device. Note the information below for storage:

- Always store the replaceable battery at room temperature.
- Check the charge status of the replaceable battery every 2 months (see “5.3.4 Operation with replaceable battery” on page 56).
- Wait until just one segment is showing in the status line before charging the battery.
- Replaceable batteries which have been stored for over a month must be charged up before they are used to guarantee an accurate display.

## 9.3 Change filter

---

### 9.3.1 Change coarse dust filter

Use original filters from the manufacturer only. Using third-party filters invalidates any claim under warranty and may result in restricted function and bioincompatibility.

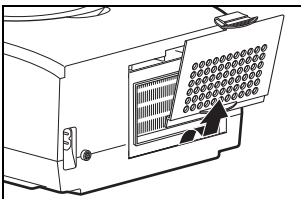

1. Press on the latch of the filter compartment lid and take it off.

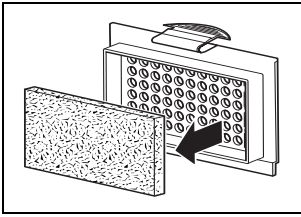



2. Take the coarse dust filter out of the filter compartment lid and dispose of it in normal domestic waste.
3. Place the clean coarse dust filter in the filter compartment lid.
4. Put the filter compartment lid into the cutout in the housing bottom edge first. Then push the filter compartment lid into the housing until the latch engages.

### 9.3.2 Change fine filter

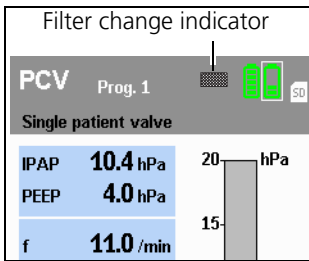
The fine filter needs changing when it has gone dark, but in any event after no more than 1000 operating hours. In the latter case, the filter change indicator  appears in the display.



Acknowledge the message by pressing the alarm acknowledgement key . The filter change symbol  then appears permanently in the status line.

Proceed as follows to change the fine filter:

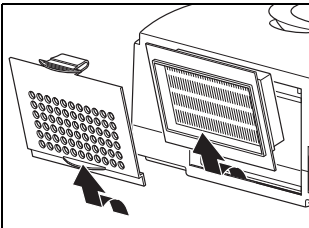

1. Press on the latch of the filter compartment lid and take it off.
2. Replace the fine filter with a new fine filter WM 15026. Dispose of the old filter in normal domestic waste.
3. Put the filter compartment lid into the cutout in the housing bottom edge first. Then push the filter compartment lid into the housing until the latch engages.

### Reset filter change indicator

After you have changed the fine filter, you must reset the filter change indicator. This is necessary even if the filter was changed before 1000 operating hours expired so the filter change symbol was not in the display.

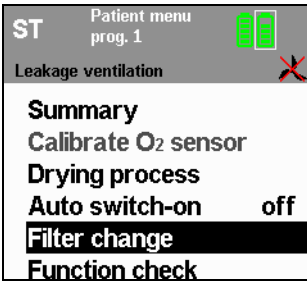

1. To reset the filter change indicator, press the menu key  and use the dial to select **Filter change** from the patient menu. Press the dial to call up the **Filter change** menu.

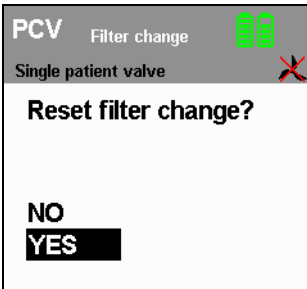

2. The question **Reset filter change?** appears. Select **YES** with the dial and confirm the selection by pressing the dial.

If you want to cancel the process, select **NO** with the dial and press the dial. The process is cancelled.

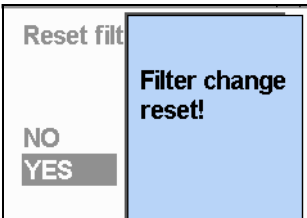

If you select and confirm **YES** with the dial, the message **Filter change reset!** appears for approx. 3 seconds.

### 9.3.3 Change fan filter

Proceed as follows to change the fan filter.

1. Turn the device over so that the underneath points upwards.
2. Grasp the fan filter with your fingertips and pull it out of the opening.

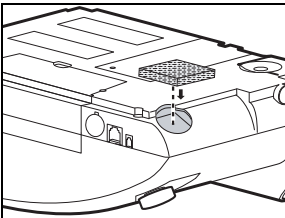

3. Take a new clean filter and put it in. Ensure that the fan filter is straight and that the corners are not tilted by the opening.
4. Turn the device back over so that the top points upwards.
5. Dispose of the used filter with domestic waste.

### 9.3.4 Bacteria filter

When using bacteria filter WM 24148, change the particulate filter in the bacteria filter in accordance with the associated instructions for use.

When using bacteria filter WM 27591, change the bacteria filter in accordance with the associated instructions for use.

## 9.4 Change pressure-measurement tube (only leakage ventilation)

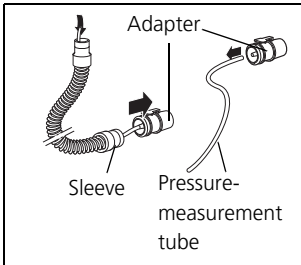

1. Release the sleeve of the creased tube from the adapter.
2. Pull the pressure-measurement tube out of the creased tube.
3. Pull the pressure-measurement tube off the adapter.

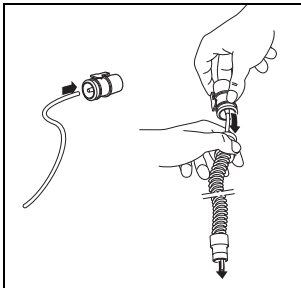

4. Push the new pressure-measurement tube onto the adapter.
5. Hold up the creased tube and guide in the free end of the new pressure measuring tube.
6. Push the sleeve of the creased tube onto the adapter.
7. Dispose of the old pressure-measurement tube.

## 9.5 Safety check

The legally-specified interval for performance of the safety check (Sicherheitstechnische Kontrolle - STK) in accordance with §6 of the German law governing medical devices [Medizinprodukte-Betreiberverordnung - Germany only] is 2 years.

In addition, servicing must be carried out as a preventive measure by the manufacturer or by a specialist dealer expressly authorized by the manufacturer, at the following intervals:

- after every 8000 operating hours (servicing symbol  appears in the display)

or

- after 2 years (see service label on the rear of the device)

depending on which comes first.

The safety check and servicing include:

- check for completeness
- visual inspection for mechanical damage
- filter change
- cleaning the device
- replacement of any defective parts
- battery change
- change of internal battery
- final check in accordance with the manufacturer’s test instruction

## 9.6 Disposal

---

### 9.6.1 Device



Do not dispose of the device with domestic waste. To dispose of the device properly, contact a licensed, certified electronic scrap disposal merchant. This address is available from your Environment Officer or from your local authority.

### 9.6.2 Batteries



Do not dispose of batteries with domestic waste. To dispose of batteries properly, contact a licensed, certified electronic scrap disposal merchant. This address is available from your Environment Officer or from your local authority.

### 9.6.3 Oxygen sensor



Do not dispose of the oxygen sensor with domestic waste, as it contains electrolyte and lead. It should be disposed of in accordance with applicable national or regional regulations.

### 9.6.4 SpO<sub>2</sub> module



Do not dispose of the SpO<sub>2</sub> *module* with domestic waste. To dispose of the SpO<sub>2</sub> *module* properly, contact a licensed, certified electronic scrap disposal merchant. This address is available from your Environment Officer or from your local authority. The device packaging (cardboard and inserts) can be disposed of in paper recycling facilities.

# 10. Scope of supply

## 10.1 Standard scope of supply

### 10.1.1 VENTIlogic LS

#### VENTIlogic LS, leakage ventilation

**WM 27940**

<b>Parts</b>	<b>Order number</b>
VENTIlogic LS basic device with panel	WM 27951
Power cord	WM 24177
Protective bag for VENTIlogic LS	WM 27106
Set, conversion to leakage ventilation, packed, consisting of:	WM 15545
– adapter, leakage ventilation	WM 27199
– drying adapter	WM 24203
– patient circuit	WM 24130
Information and spare parts set consisting of:	WM 15494
– coarse dust filter	WM 24880
– fine filter, packed	WM 15026
– coarse dust filter, fan	WM 27759
– O <sub>2</sub> coupling	WM 27166
– Hex socket wrench, size 3	WM 24708
Tube adapter (hospital adapter)	WM 15880
Instructions for use, EN	WM 67781

#### VENTIlogic LS, single patient circuit with patient valve **WM 27950**

<b>Parts</b>	<b>Order number</b>
VENTIlogic LS basic device with panel	WM 27951
Power cord	WM 24177
Protective bag for VENTIlogic LS	WM 27106
Single patient circuit valve ventilation	WM 27181
Test adapter, packed	WM 27140



<b>Parts</b>	<b>Order number</b>
Information and spare parts set consisting of: – coarse dust filter – fine filter, packed – coarse dust filter, fan – O <sub>2</sub> coupling – patient passport – Hex socket wrench, size 3	WM 15494 WM 24880 WM 15026 WM 27759 WM 27166 WM 66810 WM 24708
Adapter, leakage ventilation, packed	WM 27199
Tube adapter (hospital adapter)	WM 15880
Instructions for use, EN	WM 67781

### **VENTI*logic* LS, single patient circuit with patient valve WM 27950HLO**

<b>Parts</b>	<b>Order number</b>
VENTI <i>logic</i> LS basic device with panel	WM 27871
Power cord	WM 24177
Protective bag for VENTI <i>logic</i> LS	WM 27886
Single patient circuit valve ventilation	WM 27181
Test adapter, packed	WM 27140
Information and spare parts set consisting of: – coarse dust filter – fine filter, packed – coarse dust filter, fan – O <sub>2</sub> coupling – Hex socket wrench, size 3	WM 15494 WM 24880 WM 15026 WM 27759 WM 27166 WM 24708
Adapter, leakage ventilation, packed	WM 27199
Tube adapter (hospital adapter)	WM 15880
Patient passport	WM P-10088
Instructions for use, EN	WM 67781

## **VENTI/ologic LS, double patient circuit with patient valve WM 27960**

<b>Parts</b>	<b>Order number</b>
VENTI/ologic LS basic basic device with panel	WM 27951
Power cord	WM 24177
Protective bag for VENTI/ologic LS	WM 27106
Set, conversion to double patient circuit with patient valve, packed, consisting of:	WM 15546
– exhalation module, packed	WM 27185
– double patient circuit with patient valve	WM 27182
Test adapter, packed	WM 27140
Information and spare parts set consisting of:	WM 15494
– coarse dust filter	WM 24880
– fine filter, packed	WM 15026
– coarse dust filter, fan	WM 27759
– O <sub>2</sub> coupling	WM 27166
– patient passport	WM 66810
– Hex socket wrench, size 3	WM 24708
Tube adapter (hospital adapter)	WM 15880
Adapter, leakage ventilation, packed	WM 27199
Instructions for use, EN	WM 67781

**VENTIlogic LS, hospital****WM 27970**

<b>Parts</b>	<b>Order number</b>
VENTIlogic LS basic device with panel	WM 27951
Power cord	WM 24177
Protective bag for VENTIlogic LS	WM 27106
Single patient circuit valve ventilation	WM 27181
Patient circuit, sterilizable (leakage ventilation)	WM 24120
Set, conversion to double patient circuit with patient valve, packed, consisting of:	WM 15546
– exhalation module, packed	WM 27185
– double patient circuit with patient valve	WM 27182
Test adapter, packed	WM 27140
Adapter, leakage ventilation, packed	WM 27199
Drying adapter	WM 24203
Information and spare parts set consisting of:	WM 15494
– coarse dust filter	WM 24880
– fine filter, packed	WM 15026
– coarse dust filter, fan	WM 27759
– O <sub>2</sub> coupling	WM 27166
– patient passport	WM 66810
– Hex socket wrench, size 3	WM 24708
Set, O <sub>2</sub> measurement, consisting of:	WM 15732
– connecting cable for O <sub>2</sub> sensor	WM 27792
– O <sub>2</sub> sensor	WM 27128
– T-piece, O <sub>2</sub> sensor	WM 27143
Bacteria filter (leakage ventilation)	WM 24148
Bacteria filter (valve ventilation)	WM 27591
Tube adapter (hospital adapter)	WM 15880
Instructions for use of VENTIlogic LS, EN for patients and caregivers	WM 67781
Instructions for use of VENTIlogic LS, EN for medical personnel	WM 67801
Quick reference, EN	WM 67621

## 10.1.2 VENTIlogic plus

### VENTIlogic plus, leakage ventilation

**WM 27980**

<b>Parts</b>	<b>Order number</b>
VENTIlogic plus basic device with panel	WM 27991
Power cord	WM 24177
Protective bag for VENTIlogic plus	WM 27106
Set, conversion to leakage ventilation, packed, consisting of:	WM 15545
– adapter, leakage ventilation	WM 27199
– drying adapter	WM 24203
– patient circuit	WM 24130
Information and spare parts set consisting of:	WM 15494
– coarse dust filter	WM 24880
– fine filter, packed	WM 15026
– coarse dust filter, fan	WM 27759
– O <sub>2</sub> coupling	WM 27166
– patient passport	WM 66810
– Hex socket wrench, size 3	WM 24708
Instructions for use, EN	WM 67781

### VENTIlogic plus, single patient circuit with patient valve WM 27990

<b>Parts</b>	<b>Order number</b>
VENTIlogic plus basic device with panel	WM 27991
Power cord	WM 24177
Protective bag for VENTIlogic plus	WM 27106
Single patient circuit valve ventilation	WM 27181
Test adapter, packed	WM 27140
Information and spare parts set consisting of:	WM 15494
– coarse dust filter	WM 24880
– fine filter, packed	WM 15026
– coarse dust filter, fan	WM 27759
– O <sub>2</sub> coupling	WM 27166
– patient passport	WM 66810
– Hex socket wrench, size 3	WM 24708
Instructions for use, EN	WM 67781

## **VENTI*logic* plus, single patient circuit with patient valve WM 27990HLO**

<b>Parts</b>	<b>Order number</b>
VENTI <i>logic</i> plus basic device with panel	WM 27874
Power cord	WM 24177
Protective bag for VENTI <i>logic</i> plus	WM 27886
Single patient circuit valve ventilation	WM 27181
Test adapter, packed	WM 27140
Information and spare parts set consisting of:	WM 15494
– coarse dust filter	WM 24880
– fine filter, packed	WM 15026
– coarse dust filter, fan	WM 27759
– O <sub>2</sub> coupling	WM 27166
– patient passport	WM 66810
– Hex socket wrench, size 3	WM 24708
Patient passport	WM P-10088
Instructions for use, EN	WM 67781

## **10.2 Accessories and spare parts**

---

You can order accessories and spare parts separately if required. A current list of accessories and replacement parts can be ordered on the internet site of the manufacturer or through your authorized specialist dealer.

# 11. Technical data

## 11.1 Therapy device

	<b>Therapy device</b>	
Product class to Directive 93/42/EEC	IIb	
Dimensions W x H x D in cm	24 x 15.3 x 34	
Weight	approx. 5.9 kg excluding replaceable battery approx. 6.5 kg including replaceable battery	
Temperature range – operation – storage	+5 °C to +35 °C –40 °C to +70 °C	
Air pressure range	600 – 1100 hPa (keep leaks small below 700 hPa, as the device may no longer be able to compensate at very high ventilation pressures)	
Electrical rating	100-230 V AC, 50-60 Hz Tolerance -20 % +10 %	
Current consumption during – operation – standby	<b>230 V</b> 0.35 A 0.05 A	<b>100 V</b> 0.8 A 0.14 A
Maximum power consumption	120 W	
Breaking capacity of remote alarm connection	60 V DC/2 A; 42 V AC/2 A	
Internal battery – Model – Nominal capacity – Nominal voltage – Nominal output	Li-Ion 3100 mAh 39.6 V 121 Wh	
Life span of internal battery (internal and removable battery together)  – service life for typical load cases depending on age and ambient temperature	Load case 1 : PEEP=0hPa, f=20/min, Ti/T=40%, R=8hPa/l/s, C=40ml/hPa, Vt=300ml, <b>approx. 8.5 h (17 h)</b>  Load case 2 : PEEP=0hPa, f=20/min, Ti/T=50%, R=5hPa/l/s, C=50ml/hPa, Vt=800ml, <b>approx. 6.25 h (12.5 h)</b>	

	<b>Therapy device</b>
Duration of battery charging process	approx. 6 h
Classification to EN 60601-1 – type of protection against electric shock – degree of protection against electric shock	Protection class II  Type BF
Degrees of protection for operation in transportation case – Against the ingress of solid particles – Against access to hazardous parts – Against the harmful ingress of water	IP22
Electromagnetic compatibility (EMC) to EN 60601-1-2: – radio interference suppression – radio interference immunity	EN 55011 EN 61000-3-2, EN 61000-3-3, EN 61000-4-2 to 6, EN 61000-4-8, EN 61000-4-11
Mean sound pressure level/ operation to EN ISO 17510 at a distance of 1 m from the device in the patient position	approx. 28 dB (A) at 10 hPa
Sound pressure level of alarm message	approx. 69 dB (A) to EN 60601-1-8
IPAP pressure range EPAP / PEEP pressure range CPAP pressure range Pressure accuracy Increment	6 to 40 hPa (leakage ventilation) 4 to 45 hPa (valve ventilation) 4 to 20 hPa (leakage ventilation) 0 to 20 hPa (valve ventilation) 4 to 20 hPa (leakage ventilation) up to 35 hPa ± 0.8 hPa from 35 hPa ± 1.5 hPa 0.2 hPa (1 hPa = 1 mbar ≈ 1 cm H <sub>2</sub> O)

	<b>Therapy device</b>
Minimum stable limit pressure (PLS <sub>min</sub> ) (min. pressure in the event of a fault)	≥ 0 hPa
Maximum stable limit pressure (PLS <sub>max</sub> ) (max. pressure in the event of a fault)	≤ 60 hPa
Respiratory frequency	5 to 45 bpm
Accuracy	± 0.5 bpm
Increment	0.5 bpm
I:E (Ti/T):	
Inspiration time	15 % to 67 % of respiratory period
Increment	1 %
Accuracy	±1 %
Trigger stage	adjustable in 8 stages for inspiration and 14 stages for exhalation (from 5 % to 95 % of maximum flow), can be switched off for exhalation in ST mode
Speed of pressure rise	can be adjusted in 6 stages
Speed of pressure drop	for leakage ventilation: can be adjusted in 6 stages for valve ventilation: 1 fixed stage
Tidal volume	50-3000 ml
Accuracy of volume measurement	
Measuring range	at 23 °C: ±20 %, at least 25 ml
50 ml to 3000 ml	
Max. permitted flow rate for oxygen supply	15 l/min at ≤ 1000 hPa
Max. heating of respiratory air at 35 °C ambient temperature	41 °C
Pressure consistency measured to EN ISO 17510 in CPAP mode	<10 hPa: Δp ≤ 0.5 hPa >10 hPa: Δp ≤ 1.0 hPa
Fine filter degree of separation up to 2 μm	≥ 99.7 %
Fine filter service life	1000 hours in normal ambient air
Permitted humidity in operation and storage	≤ 95 % rh (no condensation)



	<b>Therapy device</b>
Flow at max. speed at 0 hPa	Leakage ventilation: 350 l/min Single patient circuit with patient valve: 345 l/min Double patient circuit with patient valve (VENTI <sup>logic</sup> LS only): 345 l/min
Tolerance	±15 l/min
Flow at max. speed with bacteria filter at 0 hPa:	Leakage ventilation: 320 l/min Single patient circuit with patient valve: 330 l/min Double patient circuit with patient valve (VENTI <sup>logic</sup> LS only): 330 l/min
Tolerance	±15 l/min
Filtering and smoothing techniques	<ul style="list-style-type: none"> <li>– Actual values: recalculated after each breath (no averaging)</li> <li>– Mean values: calculated across all breaths since the device started</li> <li>– AirTrap statistics: calculated across all breaths since the device was started up.</li> <li>– Leakage: calculated continuously, updated after each breath</li> <li>– Volume compensation: In the "slow" stage, the device checks after 8 breaths whether the target volume has been reached and changes the pressure by 0.5 hPa. If the pressure reaches a corridor around the target volume, the device switches to precise control. In the "medium" stage, the device checks after 5 breaths whether the target volume has been reached and changes the pressure by 1.0 hPa. If the pressure reaches a corridor around the target volume, the device switches to precise control. In the "fast" stage, the device checks after each breath whether the target volume has been reached and changes the pressure by 1.5 hPa. If the pressure reaches a corridor around the target volume, the device switches to precise control</li> <li>– Physiological alarms: "low" alarms are triggered when the relevant alarm limit has been undershot in at least three of the last five breaths. The alarms are automatically reset as soon as the relevant alarm limit has been exceeded again in at least three of the five following breaths. "High" alarms are triggered and reset correspondingly when the alarm limit is exceeded.</li> <li>– display Ti, Te, frequency, Ti/T: low-pass filter</li> <li>– alarm frequency: low-pass filter</li> <li>– pressure display in the P(t) and PV loop display: low-pass filter and gradient filter</li> </ul>

	<b>Therapy device</b>
Continuous pressure algorithm	Pressure is monitored by means of a pressure sensor. If the therapy pressure does not change its value by at least $\pm 8\%$ for at least 15 seconds, the alarm is triggered.

The right to make design modifications is reserved.

The measured values specified apply to ATPD conditions.

No part of the therapy devices contains latex.

## 11.2 System resistances

<b>System resistance at an air flow rate of 60 l/min at the patient connection opening</b>			
<b>Accessories</b>	<b>Therapy device with tube system WM 24130 (leakage system) and Silentflow WM 23600</b>	<b>Therapy device with single patient circuit with patient valve</b>	<b>VENTIlogic LS with double patient circuit with patient valve</b>
Standard configuration	0.24 $\frac{\text{kPa} \cdot \text{s}}{\text{l}}$	0.38 $\frac{\text{kPa} \cdot \text{s}}{\text{l}}$	0.4 $\frac{\text{kPa} \cdot \text{s}}{\text{l}}$
O <sub>2</sub> sensor WM 27128	-	0.47 $\frac{\text{kPa} \cdot \text{s}}{\text{l}}$	0.49 $\frac{\text{kPa} \cdot \text{s}}{\text{l}}$
Bacteria filter WM 27591	-	0.48 $\frac{\text{kPa} \cdot \text{s}}{\text{l}}$	0.5 $\frac{\text{kPa} \cdot \text{s}}{\text{l}}$
O <sub>2</sub> sensor WM 27128 and bacteria filter WM 27591	-	0.57 $\frac{\text{kPa} \cdot \text{s}}{\text{l}}$	0.59 $\frac{\text{kPa} \cdot \text{s}}{\text{l}}$

System resistances do not change in the first instance of a fault.

## 11.3 Bacteria filter WM 24148 and WM 27591

<b>Bacteria filter WM 24148 for leakage ventilation</b>	
Product class to Directive 93/42/EEC	Ila
Dimensions Ø x L in cm	7.4 x 9.8
Weight	approx. 51 g
Temperature range – operation – storage	+5 °C to +40 °C -20 °C to +70 °C
Permitted humidity in operation and storage	95 % rh (no condensation)
Ambient pressure range	700 to 1060 mbar
Increase in sound pressure level at a distance of 1 m from the device in patient position as per EN ISO 17510	Max. 0.5 dB(A)
VT	1.5 l
max. permitted flow (flowing off freely)	300 l/min
Internal volume of bacteria filter	85 ml
Therapy pressure range	3 to 35 hPa
Effectiveness of filtration tested to EN 13328-1	
Usage time for particulate filter	24 h
Material of housing	PC
Housing can be autoclaved in devices to EN 285	134 °C

## 11.4 Oxygen sensor

<b>Oxygen sensor</b>	
Measuring range	0-100 % oxygen
Linear fault	< 3 % of measuring range limit value
Response time $T_{90}$	< 12 s
Drift (at constant temperature and constant pressure over 6 h)  – 21 % oxygen:  – 60 % oxygen:	< 3 % of final measured range value < 4 % of final measured range value
Temperature range – operation  – storage	0 °C to +50 °C  -20 °C to +50 °C (recommended: +5 °C to +15 °C)
Permitted humidity in operation and storage	95 % rh

## 11.5 SpO<sub>2</sub> module

<b>SpO<sub>2</sub> module</b>	
Dimensions W x H x D	67 x 66 x 28 mm
Weight	approx. 150 g
Cable length up to finger clip sensor	2.5 m
Display SpO <sub>2</sub>	45 to 100 %
Pulse	20 to 300 bpm

<b>SpO<sub>2</sub> module</b>	
Temperature range – operation	5 °C to +40 °C
– storage	-25 °C to +70 °C
Permitted humidity in operation and storage	10 to 95%, no condensation

## 11.6 Analog box with therapy device

Channel	Measured value	Scaling	
		0 V	1 V
Channel 1	Mask pressure	0 hPa	VENTI <i>logic</i> plus: 55 hPa, VENTI <i>logic</i> LS: 55 hPa
Channel 2	Flow	-100 l/min	+320 l/min
Channel 3	Leakage flow	0 l/min	+320 l/min
Channel 4	Tidal volumes	0 ml	3000 ml
Channel 5	– All spontaneous respiration modes: on inspiration trigger – All mandatory modes: not in use	– All spontaneous respiration modes: on inspiration trigger – All mandatory modes: not in use	– All spontaneous respiration modes: on inspiration trigger – All mandatory modes: not in use
Channel 6	not in use	not in use	not in use
Channel 7	not in use	–	–
Channel 8	not in use	–	–

# 11.7 Pneumatic diagrams

## 11.7.1 Leakage ventilation

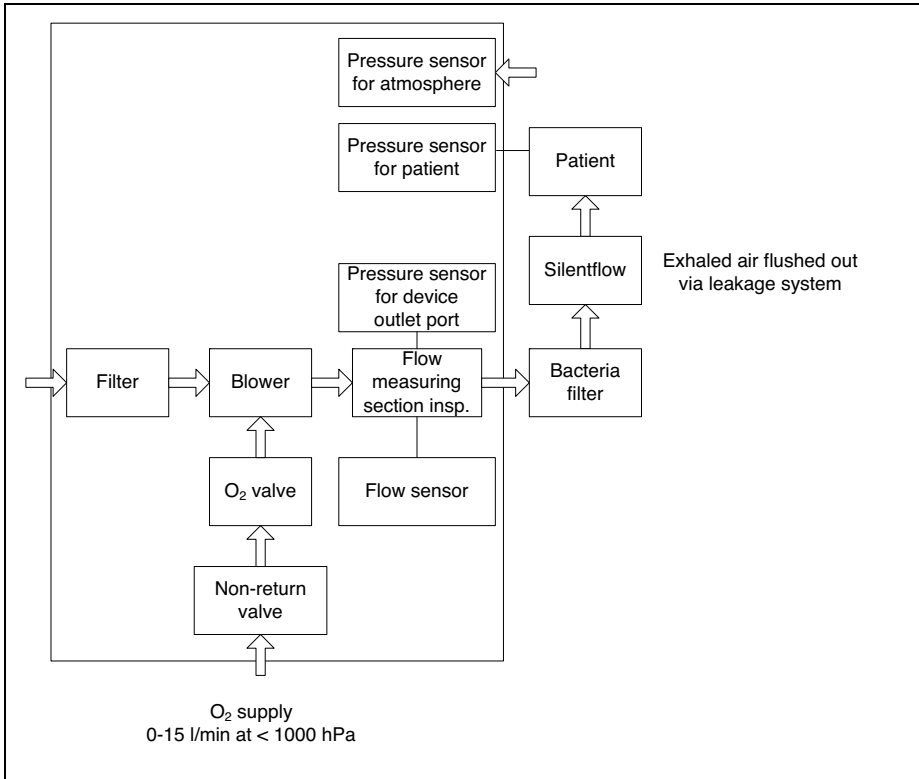

## 11.7.2 Single patient circuit with patient valve

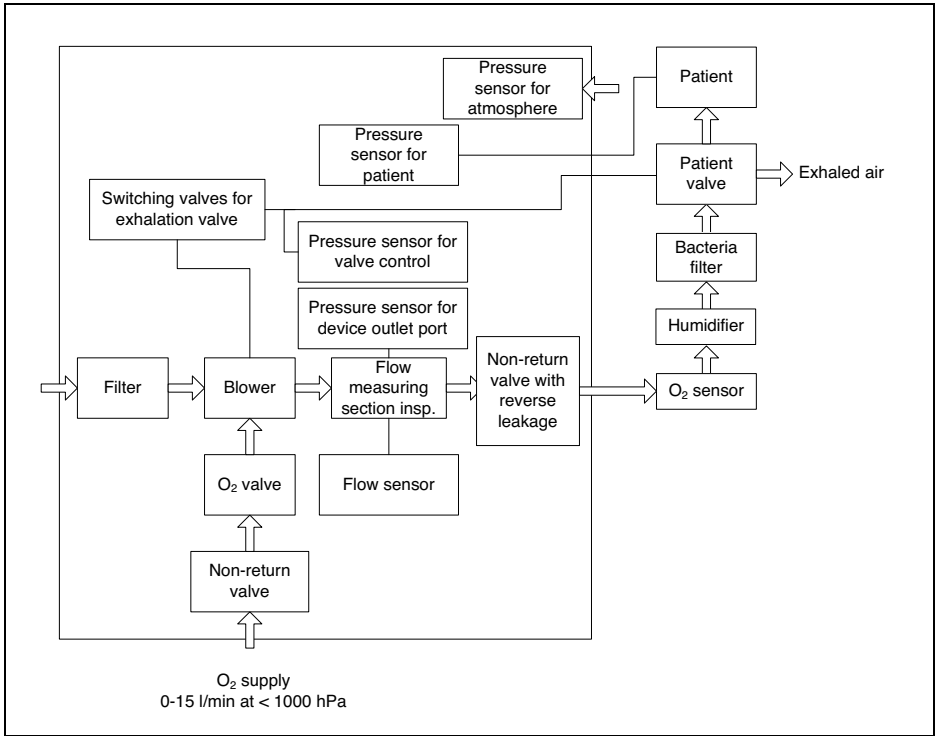

### 11.7.3 Double patient circuit with patient valve (VENTIlog<sup>ic</sup> LS only)

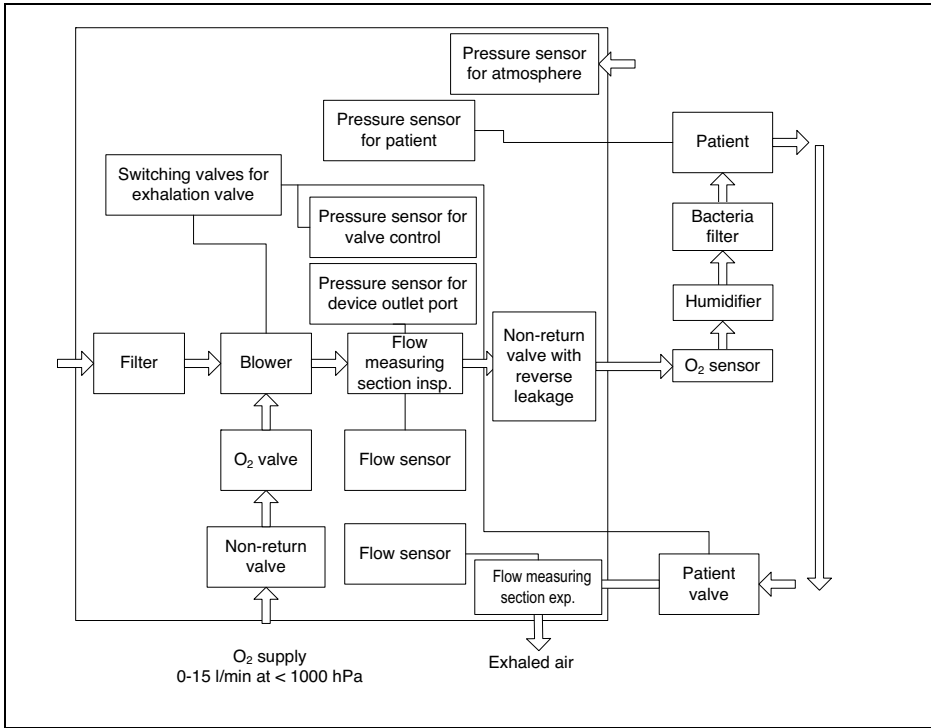



# 11.8 Safety distances

<b>Recommended safety distances between portable HF telecommunication devices (e.g. cellphone) and the therapy device</b>				
<b>Nominal output of HF device</b>	<b>Safety distance depending on transmission frequency</b>			
	<b>in m</b>			
<b>in W</b>	<b>150 kHz - 80 MHz outside ISM bands</b>	<b>150 kHz - 80 MHz within ISM bands</b>	<b>80 MHz – 800 MHz</b>	<b>800 MHz – 2.5 GHz</b>
0.01	0.04	0.12	0.12	0.23
0.1	0.11	0.38	0.38	0.73
1	0.35	1.20	1.20	2.30
10	1.10	3.80	3.80	7.27
100	3.50	12.00	12.00	23.00

Further technical data are available from the manufacturer on request or from the hospital manual and in the Servicing and Repair instructions.

The right to make design modifications is reserved.

# 11.9 Emission of electromagnetic interference

Guidelines and manufacturer declaration - emission of electromagnetic interference		
The VENTI/logic LS/VENTI/logic plus is intended for operation in an ELECTROMAGNETIC ENVIRONMENT as outlined below. The customer or the user of the VENTI/logic LS/ VENTI/logic plus should ensure that it is operated in an environment of this type.		
Measurements of interference emission	Compliance	ELECTROMAGNETIC ENVIRONMENT guideline
HF emissions to CISPR 11	Group 1	The VENTI/logic LS/VENTI/logic plus uses HF energy exclusively for its internal FUNCTION. As a consequence, its HF emission is very low and it is unlikely to interfere with adjacent electronic devices.
HF emissions to CISPR 11	Class B	The VENTI/logic LS/VENTI/logic plus is suitable for use in facilities other than the domestic sphere and in those which are connected directly to the PUBLIC POWER SUPPLY NETWORK which also supplies buildings used for habitation purposes as long as the warning below is observed. Warning: this device/system is intended only for use by medical specialists. This is a Class A device/ system to CISPR 11. In the domestic sphere, this device/system may cause radio interference with the result that in this case, it may be necessary to take suitable remedial measures, such as realigning, rearranging or shielding the VENTI/logic LS/ VENTI/logic plus, for example, or filtering the connection to the premises.
Emission of oscillations IEC 61000-3-2	Class A	
Emission of voltage fluctuations/flicker to IEC 61000-3-3	Complies	

# 11.10 Electromagnetic interference immunity

## Guidelines and manufacturer declaration - electromagnetic INTERFERENCE IMMUNITY

The VENTIlogic LS/VENTIlogic plus is intended for operation in the ELECTROMAGNETIC ENVIRONMENT as outlined below. The customer or the user of the VENTIlogic LS/ VENTIlogic plus should ensure that it is used in an environment of this type.

INTERFERENCE IMMUNITY tests	IEC 60601 TEST LEVEL	COMPLIANCE LEVEL	ELECTROMAGNETIC ENVIRONMENT guideline
DISCHARGE OF STATIC ELECTRICITY (ESD) to IEC 61000-4-2	± 6 kV contact discharge ± 8 kV air discharge	± 6 kV contact discharge ± 8 kV air discharge	Floors should be made of wood or concrete or have ceramic tiles laid on them. If the floor has a synthetic material laid on it, relative humidity must be at least 30 %.
Electrical fast transients/bursts to IEC 61000-4-4	± 2 kV for power supply cables ± 1 kV for input and output cables	± 2 kV for power supply cables ± 1 kV for input and output cables	The quality of the supply voltage should correspond to that of a typical business or hospital environment.
Surge immunity to IEC 61000-4:-5	± 1 kV voltage line - line ± 2 kV voltage line - ground	± 1 kV voltage line - line ± 2 kV voltage line - ground	The quality of the supply voltage should correspond to that of a typical business or hospital environment.
Voltage dips, short interruptions and voltage variations in supply voltage to IEC 61000-4-11	< 5 % UT (> 95 % dip in UT) for 1/2 period 40 % UT (60 % dip in UT) for 5 periods 70 % UT (30 % dip in UT) for 25 periods < 5 % UT (> 95 % dip in UT) for 5 s	< 5 % UT (> 95 % dip in UT) for 1/2 period 40 % UT (60 % dip in UT) for 5 periods 70 % UT (30 % dip in UT) for 25 periods < 5 % UT (> 95 % dip in UT) for 5 s	The quality of the supply voltage should correspond to that of a typical business or hospital environment. If the user of the VENTIlogic LS/ VENTIlogic plus requires continued FUNCTION, even in the event of interruptions to the power supply, it is recommended that the VENTIlogic LS/VENTIlogic plus be supplied from an uninterruptible power supply or a battery.

**Guidelines and manufacturer declaration - electromagnetic INTERFERENCE IMMUNITY**

The VENTI/logic LS/VENTI/logic plus is intended for operation in the ELECTROMAGNETIC ENVIRONMENT as outlined below. The customer or the user of the VENTI/logic LS/ VENTI/logic plus should ensure that it is used in an environment of this type.

Magnetic field at power frequency (50/60 Hz) to IEC 61000-4-8	3 A/m	3 A/m	Magnetic fields at power supply frequency should correspond to the values typical of those found in business and hospital environments.
---	-------	-------	---

NOTE: UT is the alternating line voltage prior to application of the test levels.

# 11.11 Electromagnetic interference immunity for life-supporting medical electrical devices and medical electrical systems

<b>Guidelines and manufacturer declaration - electromagnetic INTERFERENCE IMMUNITY</b>			
The VENTI <i>logic</i> LS/VENTI <i>logic</i> plus is intended for operation in the ELECTROMAGNETIC ENVIRONMENT as outlined below. The customer or the user of the VENTI <i>logic</i> LS/VENTI <i>logic</i> plus should ensure that it is used in an environment of this type.			
<b>INTERFERENCE IMMUNITY tests</b>	<b>IEC 60601 TEST LEVEL</b>	<b>COMPLIANCE LEVEL</b>	<b>ELECTROMAGNETIC ENVIRONMENT guideline</b>
			Portable and mobile radio devices should not be used at a distance from the VENTI <i>logic</i> LS (including its cables) of less than the recommended safety distance calculated in accordance with the equation applicable to the transmission frequency. Recommended safety distance:
Conducted HF interference to IEC 61000-4:-6	10 V <sub>effective value</sub> 150 kHz to 80 MHz within ISM bands	10 V	1.7 m
Radiated HF interference to IEC 61000-4:-3	10 V/m 80 MHz bis 2.5 GHz	10 V/m	1.7 m for 80 MHz to 800 MHz 3.25 m for 800 MHz to 2.5 GHz
Magnetic field at power frequency (50/60 Hz) to IEC 61000-4-8	3 A/m	3 A/m	Magnetic fields at power supply frequency should correspond to the values typical of those found in business and hospital environments.

## 11.12 Electromagnetic interference immunity for NON-LIFE-SUPPORTING medical electrical devices or medical electrical systems

<b>Guidelines and manufacturer declaration - electromagnetic INTERFERENCE IMMUNITY</b>			
The VENTI/logic LS/VENTI/logic plus is intended for operation in the ELECTROMAGNETIC ENVIRONMENT as outlined below. The customer or the user of the VENTI/logic LS/ VENTI/logic plus should ensure that it is used in an environment of this type.			
<b>INTERFERENCE IMMUNITY tests</b>	<b>IEC 60601 TEST LEVEL</b>	<b>COMPLIANCE LEVEL</b>	<b>ELECTROMAGNETIC ENVIRONMENT guideline</b>
			Portable and mobile radio devices should not be used at a distance from the VENTI/logic LS (including its cables) of less than the recommended safety distance calculated in accordance with the equation applicable to the transmission frequency. Recommended safety distance:
Conducted HF interference to IEC 61000-4:-6	3 V <sub>effective value</sub> 150 kHz bis 80 MHz	10 V	1.7 m
Radiated HF interference to IEC 61000-4:-3	3 V/m 80 MHz bis 2.5 GHz	10 V/m	1.7 m for 80 MHz to 800 MHz 1 m for 800 MHz to 2.5 GHz

## 12. Warranty

---

Löwenstein Medical gives the customer a limited manufacturer warranty on new original Löwenstein Medical products and any replacement part fitted by Löwenstein Medical in accordance with the warranty conditions applicable to the product in question and in accordance with the warranty periods from date of purchase as listed below. The warranty conditions are available on the website of the manufacturer. We can also send you the warranty conditions on request.

In the event of a claim under warranty, contact your specialist dealer.

<b>Product</b>	<b>Warranty period</b>
Löwenstein Medical devices including accessories (except masks)	2 years
Masks including accessories, rechargeable batteries, batteries (unless quoted differently in the technical documentation), sensors, tube systems	6 months
Disposable products	None

## 13. Declaration of conformity

---

Löwenstein Medical Technology GmbH + Co. KG, KronsaaSweg 40, 22525 Hamburg, Germany, the manufacturer of the devices described in these Instructions for Use, hereby declares that the product complies with the respective regulations of Medical Devices Directive 93/42/EEC. The unabridged text of the Declaration of Conformity can be found on the manufacturer's website.

WM 67781FW0 04/2018 EN

CE 0197

**Löwenstein Medical  
Technology GmbH + Co. KG**  
Kronsaalsweg 40  
22525 Hamburg, Germany  
T: +49 40 54702-0  
F: +49 40 54702-461  
[www.loewensteinmedical.de](http://www.loewensteinmedical.de)



WM 67781FW0



**LÖWENSTEIN**  
medical

The logo features a stylized arch composed of two parallel lines above the company name. The word "LÖWENSTEIN" is in a bold, uppercase sans-serif font, and "medical" is in a lowercase sans-serif font below it.