

# leon *plus*

*User manual*

**Rev. 3.11.13**

**from software version 3.11.x**

As at 03.11.2022





Please read this instruction manual carefully  
before using the device and keep it to hand at all  
times!

*plus*  
**leon**

Copyright © 2022 Löwenstein Medical SE & Co. KG

Subject to change  
03.11.2022

Löwenstein Medical SE & Co. KG  
Arzbacher Straße 80  
56130 Bad Ems, Germany

 : +49 2603/9600-0  
 : +49 2603/9600-50  
 : [loewensteinmedical.com](http://loewensteinmedical.com)

User manual *leon plus*  
Order no.: Ba-0301v311

CE 0197



## Table of Contents

<b>1.</b>	<b>List of abbreviations</b> .....	<b>11</b>
<b>2.</b>	<b>About this User manual</b> .....	<b>15</b>
	Validity of this instruction manual.....	15
	Essential information covered by the instruction manual.....	15
	Structure and purpose of the User manual .....	16
	Description of options.....	16
	Retention of documentation .....	16
	Further information .....	16
<b>3.</b>	<b>Safety for you and the patient</b> .....	<b>17</b>
	User manual compliance .....	17
	Warnings .....	17
	Residual hazards .....	18
	Messages to the manufacturer and authorities .....	19
	Liability and guarantee .....	20
	Classification of the device .....	21
	Maintenance instructions .....	21
<b>4.</b>	<b>Device overview</b> .....	<b>22</b>
	Intended use .....	22
	Operating requirements.....	22
	Forms of ventilation .....	22
	Anaesthesia systems.....	23
	Contraindications.....	23
	Guidelines and manufacturer's declaration – Electromagnetic emissions.....	24
	Guidelines and manufacturer's declaration – Electromagnetic immunity .....	25
	Device description.....	29
	Overview.....	29
	Patient module.....	31
	Anaesthetic vaporiser mounting .....	31
	Ventilator .....	31
	Railing system .....	32
	Writing shelf, drawers, storage compartment.....	33
	Tube and cable guides .....	34
	Delivery contents .....	35
	Operating instructions .....	36
<b>5.</b>	<b>Operating concept</b> .....	<b>37</b>
	Function levels .....	37
	Icons.....	39
	User interface.....	47
	Concepts .....	47
	Keypad .....	48
	Touchscreen.....	49
	Rotary switch .....	51
	Tab system .....	52
	Title bar.....	52

HLM form of ventilation .....	53
MON form of ventilation .....	53
Monitoring of muting of alarm .....	54
Screensaver .....	54
Control elements and displays .....	55
Front.....	55
Options board .....	57
Device connections .....	59
Description of device connections .....	59
Operation of the device connections .....	60
Rear wall .....	63
Patient module.....	64
Removing the patient module .....	64
Connection for ventilation tubes, anaesthesia gas scavenging system and ventilation bag .....	65
Connection of the AGSS on the rear of the device.....	65
Connection for respiratory bellows, dome and CO <sub>2</sub> absorber, PEEP valve diaphragm cover, flow sensors .....	66
APL valve.....	67
Bronchial aspiration .....	67
<b>6. Preparations.....</b>	<b>68</b>
First installation.....	68
Adaptation to ambient conditions.....	68
Customer requirements at the application site (leon <i>plus</i> – Standard configuration).....	69
Emergency power supply .....	70
Charging batteries.....	70
Out-of-operation for a longer period .....	70
Preparation for start-up .....	71
Gas connections .....	71
Electrical connections .....	77
Connection of the respiratory bellows and the dome .....	79
Removing and installing the CO <sub>2</sub> absorber.....	79
Changing, emptying, filling the CO <sub>2</sub> absorber.....	80
Connection of the ventilation tubes.....	82
Gas measurement .....	83
Connection of the ventilation bag .....	86
Connection to the anaesthesia gas scavenging system.....	87
Suspension bracket of the intake system on the rear of the device .....	89
APL valve.....	90
Setting up the anaesthetic vaporiser .....	90
Connection of the bronchial aspiration .....	91
Connection of auxiliary devices .....	92
Connection of data communication .....	93
<b>7. Start-up.....</b>	<b>94</b>
Short check (recommended by DGAI) .....	95
Configuration (in standby) .....	96

Config tab .....	96
Volume tab .....	98
System Time tab.....	99
Option tab .....	100
Configuration (during ventilation) .....	100
Config tab .....	100
Volume tab .....	101
Option tab .....	101
System configuration of the user interface .....	101
Service .....	106
Login .....	107
Service tab.....	108
Configuration tab/page 1 .....	111
Configuration tab/page 2 .....	115
Procedure for saving the system configuration .....	116
Device check.....	118
Selftest.....	118
System test.....	119
Short checklist before start-up.....	119
Limited start-up option .....	120
Turn on .....	120
System test .....	122
General information .....	122
Operating states of the system test block .....	123
Results of the selftest .....	124
O <sub>2</sub> emergency dosing during the system test.....	124
External fresh gas outlet before the system test .....	125
Start of the system test.....	125
Skip/cancel system test (Quick start) .....	126
Back to the system test from standby .....	127
Execution of the system test .....	127
Passed system test and display of values for compliance and leakage rate .....	128
System test not passed and detailed error display .....	128
Display of values for compliance and leakage rate .....	129
Repeating individual system test blocks.....	129
Tightness of tube system and full system .....	130
System test procedure .....	131
FiO <sub>2</sub> calibration.....	132
Start of FiO <sub>2</sub> calibration .....	132
Execution of the FiO <sub>2</sub> calibration .....	132
Passed FiO <sub>2</sub> calibration .....	132
FiO <sub>2</sub> calibration not passed .....	133
Alarm test .....	133
General information .....	133
Test of alarm functions .....	134
Power off .....	138

	O <sub>2</sub> emergency dosing during shutdown of the device .....	139
<b>8.</b>	<b>Ventilation .....</b>	<b>140</b>
	General information .....	140
	Compliance compensation .....	140
	Patient categories .....	140
	Weight (IBW).....	141
	Load default settings.....	143
	Behaviour of the P <sub>insp</sub> . Setting upon change to the PEEP settings .....	143
	Moisture in the ventilation system.....	144
	Low flow and minimal flow .....	144
	Fresh gas setting .....	145
	Fresh gas ecometer .....	147
	Borderline fresh gas settings .....	148
	Setting of the anaesthetic vaporiser .....	148
	Quick start .....	149
	Manual operation during the boot process and the selftest.....	149
	Execute quick start.....	150
	Forms of ventilation .....	151
	Manual ventilation .....	151
	Mechanical ventilation .....	157
	Description of the forms of ventilation.....	162
<b>9.</b>	<b>Monitoring .....</b>	<b>175</b>
	General information .....	175
	Data .....	176
	Alarm muting (mute) .....	178
	Limit values .....	178
	Alarm messages .....	178
	Batteries.....	178
	Device functions.....	178
	Monitored data.....	179
	Measured values as graphical display.....	179
	Tabular trend.....	182
	Event log .....	183
	Measured values in a numerical display.....	184
	Entry of age for MAC calculation .....	189
	Manual selection of the narcotic gas .....	190
	Detection of triggered breaths .....	190
	Loops (monitoring of lung function) .....	191
<b>10.</b>	<b>Monitoring of device functions .....</b>	<b>192</b>
	Fresh gas blender.....	193
	Intact fresh gas blender .....	193
	Fresh gas blender in the event of failure of a carrier gas .....	193
	Display of damaged fresh gas blender .....	194
	Gas supply pressures.....	194
	Central gas supply pressures .....	195

Pressure display when supply from 10 L bottles .....	196
Drive gas generator.....	197
Gas measurement.....	197
Fresh gas shortage .....	198
Docking station with patient module .....	198
CO <sub>2</sub> absorber .....	198
Fans .....	198
Batteries .....	199
Stopwatch .....	199
<b>11. Alarms .....</b>	<b>200</b>
General information.....	200
Display of current alarms.....	200
Factory settings of the alarms .....	202
Alarm muting.....	204
Alarm muting 2 minutes.....	204
10 minute alarm muting .....	205
Alarm log .....	206
Limit values (patient alarm limits).....	207
Setting patient alarm limits manually.....	207
Adjustable alarm limits .....	208
Display of apnoea duration.....	208
Application area and increment of alarm.....	209
Adjusting alarm limits to current measured value (autoset) .....	211
Alarm limits that are automatically followed .....	212
Active alarms .....	212
List of alarm messages .....	214
<b>12. Errors and measures .....</b>	<b>233</b>
General information.....	233
Patient monitoring.....	233
Pressure relief valve .....	234
Defined safe state .....	235
Patientsafe defined safe state .....	235
Failsafe defined safe state .....	236
Inoperability or failure of the device.....	237
Self check error search .....	239
Gas supply error search .....	239
Self check error search .....	239
Error search system test .....	240
Error search gas type check.....	240
Error search fresh gas blender .....	241
Error search respirator .....	243
Error search flow sensors.....	244
Error search circulation system .....	245
Error search FiO <sub>2</sub> calibration .....	248
External supply units failure .....	249
No central gas supply .....	249

Mains supply failure .....	252
Failure of the anaesthesia gas scavenging system .....	254
Failure of internal units .....	255
Touchscreen failure .....	255
Fresh gas dosing failure .....	256
Ventilator failure .....	258
Gas measurement failed .....	259
Flow measurement failure .....	260
Pressure measurement failure .....	261
<b>13. Maintenance and servicing .....</b>	<b>262</b>
General information .....	262
Servicing by hospital staff .....	262
Change CO <sub>2</sub> absorber .....	262
Change bronchial aspiration filter .....	262
Gas measurement maintenance (sidestream measurement) .....	263
Flow sensor servicing .....	265
PEEP valve diaphragm servicing .....	266
Servicing of the insp./exp. valve diaphragms .....	267
Servicing of fans .....	268
Servicing of reserve gas bottles and 10 L bottles .....	269
Disposal .....	272
Disposal of gas .....	272
Disposal of soda lime .....	272
Disposal of bronchial aspiration filter .....	272
Disposal of water trap and sample line .....	272
Disposal of O <sub>2</sub> sensor .....	273
Disposal of flow sensor .....	273
Disposal of valve diaphragm .....	273
Disposal of fan filter pad .....	273
Disposal of electric and electronic components of the device .....	273
Disposal of battery .....	274
Changing and filling reserve gas bottles or 10 L bottles .....	274
Maintenance by authorised service technicians .....	274
General information .....	274
Servicing interval .....	275
Replacing and calibrating the O <sub>2</sub> cell .....	276
Side power measurement servicing .....	277
Maintenance of the high-pressure regulator .....	279
Technical safety controls .....	279
<b>14. Accessories .....</b>	<b>285</b>
General information .....	285
Replacement part .....	286
Accessories .....	286
<b>15. Product combinations .....</b>	<b>287</b>
General information .....	287

Auxiliary devices .....	287
Mounting additional monitors .....	288
Anaesthetic vaporiser.....	288
Bronchial aspiration.....	288
Support arms.....	289
PDMS .....	289
HIS .....	289
AGSS .....	289
<b>16. Appendix.....</b>	<b>290</b>
Notes.....	290
Gas flow plans.....	292
Legend gas flow plans.....	292
Manual ventilation (patient module 0209100) .....	294
Mechanical ventilation (patient module 0209100).....	296
Manual ventilation (patient module 0209100hul200) .....	300
Mechanical ventilation (patient module 0209100hul200).....	302
Manual ventilation (patient module 0209100lm300) .....	306
Mechanical ventilation (patient module 0209100lm300).....	308
Calculation methods.....	312
Pressure flow characteristics .....	314
Service life of replacement parts.....	316
Life of soda lime .....	316
Life of bronchial aspiration filter.....	316
Gas measurement.....	316
Life of the flow sensors.....	317
Life of the PEEP valve diaphragm.....	317
Life of the insp./exp. valve diaphragms .....	317
Life of the fan filter pad .....	317
Service life of reusable CO <sub>2</sub> absorber .....	317
Service life of inspection glasses .....	318
Lists and short instructions .....	319
Ordering replacement parts.....	319
Ordering accessories.....	319
leon <i>plus</i> Short checklist before start-up .....	319
leon <i>plus</i> Short operating instructions .....	319
leon <i>plus</i> Technical safety controls checklist .....	319
<b>17. Technical data .....</b>	<b>320</b>
<b>18. Index.....</b>	<b>337</b>



This page has been left blank intentionally.



## 1. List of abbreviations

Abbreviation, Term	Description
A	Breath-by-breath window
Agent	Volatile anaesthetic
AGFS	<b>A</b> naesthetic <b>g</b> as <b>s</b> cavenging <b>s</b> ystem
AGS	Anaesthetic gas aspiration
AIR	Medical compressed air
APL valve	<b>A</b> adjustable <b>P</b> ressure <b>L</b> imitation Adjustable pressure-relief valve
AZV	Tidal volume
BSF	Breathing system filter
BTPS	<b>B</b> ody, <b>T</b> emperature, <b>P</b> ressure, <b>S</b> aturated Measured values standardised to BTPS requirements refer to 37°C (body temperature), current atmospheric pressure and 100% steam saturation.
C20/C	Compliance during the last 20% of the inspiration phase compared with total compliance (Measurement for overdistention of the lungs $\leq 1$ )
Calibration	To calibrate an analyser, the analyser is checked and the deviation from a standard (that is known to be correct) is determined.
Carrier gas	Gas that is used as a fresh gas along with O <sub>2</sub> General AIR or N <sub>2</sub> O
C <sub>dyn</sub>	Compliance (dynamic)
CGS	Central gas system (supply) for O <sub>2</sub> , N <sub>2</sub> O and AIR
CO <sub>2</sub>	Carbon dioxide
Compliance	Lung elasticity
CPAP	<b>C</b> ontinuous <b>P</b> ositive <b>A</b> irway <b>P</b> ressure Constant positive airway pressure
C <sub>stat.</sub>	Compliance (static)
Des.	Volatile anaesthetic – desflurane
E	Expiration
Enf.	Volatile anaesthetic – enflurane
f, Freq.	Frequency, number of breaths per minute

Table 1: Abbreviations and Terms

Abbreviation, Term	Description
FiO <sub>2</sub>	Insp. oxygen measurement
FO	Optical fibre cable
Fresh gas flow	Sum of O <sub>2</sub> gas flows and carrier gas into the anaesthesia system
Hal.	Volatile anaesthetic – halothane
HIS	Hospital information system
HLM	Heart-lung machine
I	Inspiration
I:E	Inspiration to expiration ratio
IBW	Ideal body weight
IMV	Intermittent <b>M</b> andatory <b>V</b> entilation Volume-controlled ventilation
Insp. flow	Inspiratory flow
Insp. vol	Inspiratory volume
Iso.	Volatile anaesthetic – isoflurane
Leak	Difference between inspiratory and expiratory breath volume (ventilation gas lost in ventilation tubes, on seals, cross-over points and on the tube)
Loop	Displays of flow over pressure, volume over pressure or flow over volume measured values in a coordinates system
Low flow	Fresh gas flow $\leq 1000$ ml/min and $> 500$ ml/min
MAC	<b>M</b> inimum <b>A</b> lveolar <b>C</b> oncentration
Minimal flow	Fresh gas flow $\leq 500$ ml/min
MON	Monitoring mode (to monitor sufficient spontaneously breathing patients)
MV	Minute volume
N <sub>2</sub> O	Dinitrogen monoxide (nitrous oxide)
No. of charts	Number of real-time curves (minimum 1, maximum 4)
O <sub>2</sub>	Oxygen
O <sub>2</sub> flush	Oxygen flush
Patient category Adult	Fast selection of preconfigured ventilation parameter settings and alarm limits for adult ventilation

Table 1: Abbreviations and Terms

Abbreviation, Term	Description
Patient category Child	Fast selection of preconfigured ventilation parameter settings and alarm limits for ventilation in children
Patient category IBW	Fast selection of preconfigured ventilation pattern parameter settings and alarm limits on entry of the ideal bodyweight (child alarm limits)
$P_{aw}$	Ventilation pressure
PCV	<b>P</b> ressure <b>C</b> ontrolled <b>V</b> entilation Pressure-controlled ventilation
PDMS	<b>P</b> atient <b>D</b> ata <b>M</b> anagement <b>S</b> ystem
PEEP	<b>P</b> ositive <b>E</b> nd <b>E</b> xpiratory <b>P</b> ressure Positive end-expiratory pressure
$P_{insp.}$	PCV to be reached
Plat./Plateau	Percentage length of plateau during inspiration
$P_{Mean}$	Mean ventilation pressure
$P_{Peak}$	Maximum ventilation pressure
$P_{Plat./P_{Plateau}}$	Ventilation plateau pressure
Pressure units	<ul style="list-style-type: none"> <li>▪ 100 kPa = 1 bar = approx. 1 atm</li> <li>▪ 1 atm = approx. 1 kg/cm<sup>2</sup> (kp/cm<sup>2</sup>)</li> <li>▪ 1 hPa = 100 Pa = approx. 1 cm H<sub>2</sub>O</li> <li>▪ 1 kPa = approx. 10 cm H<sub>2</sub>O</li> <li>▪ 1 bar = 1 kPa × 100</li> <li>▪ 1 mbar = approx. 1 cm H<sub>2</sub>O</li> <li>▪ 1 mm Hg = approx. 133 Pa</li> </ul>
Pressure units (standard)	<ul style="list-style-type: none"> <li>▪ 1 kPa × 100 = 1 bar</li> <li>▪ 1 Pa × 100 = 1 mbar = approx. 1 cm H<sub>2</sub>O</li> </ul>
PSV	<b>P</b> ressure <b>S</b> upport <b>V</b> entilation Pressure-supported ventilation
R/Resistance	Airway resistance
Ratio system	With N <sub>2</sub> O as the carrier gas, the minimum concentration setting for O <sub>2</sub> = 25%
RDG	Cleaning and disinfection device
Settings	Settings
Sev.	Volatile anaesthetic – sevoflurane
S-IMV	<b>S</b> ynchronized <b>I</b> ntermittent <b>M</b> andatory <b>V</b> entilation Triggered form of ventilation

Table 1: Abbreviations and Terms

Abbreviation, Term	Description
S-PCV	<b>S</b> ynchronized <b>P</b> ressure <b>C</b> ontrolled <b>V</b> entilation Triggered form of ventilation
t	Time
Trig. Flow	Flow needed to release the trigger
Trig. vol.	Volume needed to release the trigger
Trigger	Option of synchronising the ventilator of the anaesthesia workstation with spontaneous patient breathing activity
USV	Uninterrupted power supply
V	Volume
$\dot{V}$	Flow
Vapour	anaesthetic vaporiser
VGA	Video graphics array (computer graphics standard)
$V_{Te}$	Tidal volume expiration
$V_{TG}$	Tidal volume guarantee
$V_{Ti}$	Tidal volume inspiration

## 2. About this User manual

### Validity of this instruction manual

This instruction manual applies to the following products:

- leon *plus*



*These instructions for use also apply to all devices with the manufacturer's name Heinen + Löwenstein GmbH & Co. KG and with the manufacturer's information Löwenstein Medical GmbH & Co. KG.*

### Essential information covered by the instruction manual

This user manual describes the anaesthesia workstation leon *plus* and its operation. It contains:

- Information on the safe handling of the anaesthesia workstation
- An overview of all of the device components
- A description of how to operate the device
- A description of the monitor control elements
- Information on
  - Installation
  - Start-up
  - Operation
  - Monitoring and alarms
  - Errors and troubleshooting
  - Servicing
  - Accessories

Documentation for the leon *plus* anaesthesia system encompasses:

- leon *plus* instruction manual
- leon *plus*, leon and leon *mri* hygiene instructions
- Service Manual for leon *plus*, leon, leon *mri* Rev. 2.4.2
- Service manual supplementing Vers. 2.4.2 leon *plus*, leon, leon *mri*
- leon *plus* Short check list/instructions before start-up
- leon *plus*, leon and leon *mri* List of accessories and replacement parts
- Checklist of technical safety controls for leon *plus*



*The checklist, short instructions and copyable forms can be found at the end of the document.*

## Structure and purpose of the User manual

The user manual will familiarise you, step-by-step, with the operation of your anaesthesia workstation. All of the available features are described.

-  *Read through the user manual carefully, before you begin to work with the anaesthesia workstation. Continue to consult the user manual for your work until you are perfectly sure of how to handle the device and have completed all of the training sessions successfully.*

If you have detailed questions, the contents and index will help you to find a subject quickly.

-  **Tips** supplement the handling instructions. They suggest methods of operating the anaesthesia workstation more efficiently and more simply under proper safety conditions.

## Description of options

This user manual contains descriptions of standard and optional device equipment and features. No legal claim may be derived from the description of this option. You can find out which options are available in your system from your Löwenstein Medical sales partner.

## Retention of documentation

Keep the documentation to hand at all times, in a complete and readable condition, near to the device. If the device is passed on, it must be accompanied by the documentation. In the event of loss, contact Löwenstein Medical customer services immediately.

## Further information

If you have any questions or remarks regarding this instruction manual or the device, please contact your authorised regional specialist vendor or the manufacturer directly.

## 3. Safety for you and the patient

## User manual compliance

**WARNING**

Non-compliance with the user manual

**Danger of harm to patients**

- Precise knowledge and compliance with this user manual is required each time the device is used.
- The device is intended for the described use only.

This user manual is designed to help you, step-by-step, to become familiar with the operation of your anaesthesia workstation. Frequently used features are described.

- 💡 *Read through the user manual carefully, before you begin to work with the anaesthesia workstation.*

Later on, when you are familiar with the basic operation of the anaesthesia workstation, the user manual will serve as a reference for detailed questions. The contents and keywords index will help you to find a subject quickly.

## Warnings

**ATTENTION**

**ATTENTION** indicates important information, non-compliance with which could lead to damage to the device.

**CAUTION**

**CAUTION** indicates a latent hazard that does not represent a direct threat but can lead to physical injury if not avoided.

**WARNING**

**WARNING** indicates a hazard that represents a direct threat and can lead to severe injury or death if not avoided.

## Residual hazards

**Observe safety instructions and warnings**

For the proper and safe operation and use of the device, it is absolutely essential that the safety instructions and warnings, (→ "Warnings" p. 17) in addition to this user manual, are read, understood and fully observed by every user before the initial start-up.

**Operation by qualified staff**

The leon *plus* anaesthesia device may be operated only by qualified specialist medical staff who have been instructed how to operate the device, so that they are able to take immediate action in the event of malfunction.

**WARNING**

---

Device malfunctions!

**Death or permanent injury of the patient**

- During the use of the leon *plus*, an alternative ventilation system, e.g. ventilation bag with mask, must always be available, preferably with an O<sub>2</sub> tube connector.
  - If, in the event of a recognisable fault in the leon *plus* anaesthesia device, it can no longer be guaranteed that life can be sustained, the ventilation of the patient must be started promptly with independent ventilation equipment, e.g. ventilation bag with mask.
  - A device check must be carried out beforehand each time the anaesthesia workstation is used.
  - If a fault is established during the self check or the device check, the anaesthesia workstation must not be attached to a patient under any circumstances!
- 

**WARNING**

---

Working with live components!

**Risk of injury through electrocution.**

- Unplug the device from the mains before opening the housing.
  - Ensure it is not plugged in again without authorisation!
  - Before opening, remove all gas connections, including gas cylinders, from the device.
-



**WARNING**

---

Device malfunction!

**Danger from EM interferences.**

- Avoid using this device in close proximity to other equipment or with other equipment in a stack as this may result in improper operation. If use in the manner described above is nevertheless necessary, this device and the other devices should be observed to verify that they are functioning properly.
  - The use of ACCESSORIES, transducers and wiring other than those specified or provided by the MANUFACTURER of this equipment may result in increased ELECTROMAGNETIC INTERFERENCES or reduced electromagnetic immunity of the equipment and may result in improper operation.
  - PORTABLE HF communications equipment (radios) (including their ACCESSORIES such as antenna cables and external antennas) should not be used within 30 cm (or 12 inches) of leon *plus* parts and wiring designated by the MANUFACTURER. Failure to do so may reduce the performance of the device.
- 

**WARNING**

---

Flammable narcotic gases

**Fire risk**

Do **not** use **any** flammable anaesthetics!

Use only the following anaesthetics:

- halothane
  - enflurane
  - isoflurane
  - sevoflurane
  - desflurane
- 

**WARNING**

---

Lack of hygiene!

**Risk of infection**

- Prepare the device and the hose system before first use.
  - Change the tube system after each patient or use a new ventilation system filter (VSF) for each patient.
  - Use suitable ventilation system filters (VSF).
  - Do not use single-use products more than once.
- 

## Messages to the manufacturer and authorities

All serious incidents related to the device must be reported to the manufacturer and to the competent authority of the Member State where the user is established.

## Liability and guarantee

- Liability for the functioning of the device transfers in every instance to the owner or operator,
  - if the device is maintained or commissioned by persons who are not associated to Löwenstein Medical or are not authorised by Löwenstein Medical,
  - if the device is handled in a way that does not correspond to the intended use.
- Löwenstein Medical is not liable for damage arising from non-compliance with the above-mentioned instructions.
- Guarantee and liability provisions of the sale and delivery conditions of Löwenstein Medical are supplemented by the following instructions.

**Combination with other devices**

Electrical coupling with devices that are not mentioned in this user manual may only be carried out after consultation with the manufacturers or an expert.

**Do not cover or place in an unfavourable position**

The device must not be covered or positioned in such a way that its operation or functioning is influenced negatively.

**Alarms and troubleshooting**

- The anaesthesia workstation distinguishes between three types of alarms: patient alarms, system alarms and technical alarms.
- The alarms are allocated, according to the urgency of different priorities and are displayed in the alarm window according to the level of urgency (→ "Display of current alarms" p. 200).
- The alarm limits for patient alarms can be set by the user (→ "Setting patient alarm limits manually" p. 207).
- You have the option of seeing all of the alarms that have appeared in the alarm log.

**Cross-infections**

The following conditions ensure that the risk of cross-infection is reduced to a tenable risk under normal conditions and in the first fault instance:

- Appropriate use (ventilation gas filter close to the patient)
- Design of the water trap
- Return of the test gas before the CO<sub>2</sub> absorber
- Gas return filter into the patient part

## Classification of the device

Table 2: Classification

Device group in accordance with 93/42/EEC Appendix IX	IIb
Protection class lt. EN 60601-1	I Type B
Operation type	suitable for permanent use

## Maintenance instructions

- a technical safety check and servicing must be carried out every 12 months, which must be executed in accordance with the instructions of Löwenstein Medical.
- every 3 years, at the latest every 10,000 operating hours, 10,000 hour servicing must be carried out, which must be executed in accordance with the manufacturer's instructions.
- every 6 years, at the latest every 20,000 operating hours, 20,000 hour servicing must be carried out, which must be executed in accordance with the manufacturer's instructions.
- the servicing may only be carried out by Löwenstein Medical-trained specialist staff, who have at their disposal suitable measuring methods and testing devices.

We recommend that you take out a service and repairs contract with a Löwenstein Medical-authorized service technician.

Use only original parts by Heinen + Löwenstein for servicing.

- 💡 *Also observe (→ "Maintenance and servicing" p. 262).*
- 💡 *Definition of servicing in accordance with DIN 31051:*
  - *Inspection: Establishing of actual state*
  - *Servicing: Methods for retaining the desired state*
  - *Repairs: Methods for restoring the desired state*
  - *Maintenance: Inspection, servicing and repairs*

## 4. Device overview

### Intended use

- The *leon plus* is an anaesthesia workstation for adults, children, infants and premature babies.
- It enables controlled, manual ventilation as well as spontaneous breathing.

### Operating requirements

---

**It is recommended that the *leon plus* is operated only as described below:**

- with VSF
- with AGSS
- in well-ventilated spaces
- with reserve gas bottles

**Only the following volatile anaesthetics may be used:**

- halothane
- enflurane
- isoflurane
- sevoflurane
- desflurane



*If you have any questions, contact the manufacturer!*

### Forms of ventilation

---

**The *leon plus* provides the following forms of ventilation:**

- intermittent mandatory ventilation (IMV)
- pressure-controlled ventilation (PCV)
- synchronised intermittent mandatory ventilation (S-IMV)
- synchronised pressure-controlled ventilation (S-PCV)
- pressure-supported ventilation (PSV)
- ventilation mode using a heart-lung machine (HLM)
- manual ventilation (MAN)
- spontaneous ventilation (SPONT)
- monitoring (MON)

## Anaesthesia systems

---

The *leon plus* supports the following systems:

- inhalation anaesthetics in the rebreathing system
- inhalation anaesthetics in semi-closed systems
  - in the low flow area
  - in the minimal flow area
- inhalation anaesthetics with non-rebreathing systems via fresh gas outlet e.g.
  - Bain
  - Magill
  - Jackson Rees
  - Kuhn

## Contraindications

---

Never use the *leon plus* as follows:

- on the MRT
- at temperatures and under ambient pressure outside of the permissible area
- Do not perform longer-term low-flow anaesthesia in patients with ketoacidosis or in alcoholised patients. This may pose a risk of acetone accumulation in the patient.
- If malignant hyperthermia is suspected: Do not use volatile anaesthetics or the *leon plus* with residual concentrations of these gases.
- Among other things, oxygen, nitrous oxide, volatile anaesthetics or medication are applied. Follow the instructions for use of the applied products carefully.
- Do not use soda lime based on potassium hydroxide. This may pose the risk of CO formation.

The user is responsible for adjusting the gas dosage and ventilation in accordance with the patient's condition. The patient's condition must be monitored continuously.

(→ "*Technical data*" p. 320)

## Guidelines and manufacturer's declaration – Electromagnetic emissions

The *leon plus* is intended for operation in the electromagnetic environment given below. The customer or user of the *leon plus* must ensure that the *leon plus* is used in such an environment.

Table 3: Guidelines and manufacturer's declaration – Electromagnetic emissions

Transmission measurements	Compliance	Electromagnetic environment - Guidance
HF transmissions in accordance with CISPR 11	Group 1	The <i>leon plus</i> only uses HF energy for its internal function. Its HF transmission is therefore very small and it is unlikely that neighbouring devices are disturbed.
HF transmissions in accordance with CISPR 11	Class B	The <i>leon plus</i> is intended for use in facilities other than residential environments. In addition, the device is suitable for use in facilities that are directly connected to a public mains network, which also supplies buildings that are used for residential purposes.
Harmonics in accordance with IEC 61000-3-2	Class A	
Voltage variations / flickers in accordance with IEC 61000-3-3	Fulfilled	

## Guidelines and manufacturer's declaration – Electromagnetic immunity

The leon *plus* is intended for operation in the electromagnetic environment given below. The customer or user of the leon *plus* must ensure that the leon *plus* is used in such an environment.



*Only use the accessories from the list in the appendix: leon plus, leon and leon mri "Accessories and replacement parts", otherwise the requirements of the device for INTERFERENCE EMISSIONS and IMMUNITY may be negatively affected.*

Table 4: Guidelines and manufacturer's declaration – Electromagnetic immunity

Immunity test	IEC 60601-test level	Compliance level	Electromagnetic environment - Guidance
Discharge of static electricity in accordance with EIEC 61000-4-2	± 8 kV contact discharge ± 2 kV, ± 4 kV, ± 8 kV, ± 15 kV air discharge	± 8 kV contact discharge ± 2 kV, ± 4 kV, ± 8 kV, ± 15 kV air discharge	Floors should consist of wood or concrete or be covered in ceramic tiles. If the floor is covered with synthetic material, the relative air humidity must amount to at least 30%.
Quick transient electrical interference / bursts in accordance with IEC 61000-4-4	± 2 kV for mains ± 1 kV for inlet and outlet lines 100 kHz repetition rate	± 2 kV for mains ± 1 kV for inlet and outlet lines 100 kHz repetition rate	The quality of the supply voltage should correspond to that of a typical business or hospital environment.
Surges in accordance with IEC 61000-4-5	± 0.5 kV, ± 1 kV push-pull voltage ± 2 kV common mode	± 0.5 kV, ± 1 kV push-pull voltage ± 2 kV common mode	The quality of the supply voltage should correspond to that of a typical business or hospital environment.
Voltage dips, short interruptions and voltage variations in the supply voltage in accordance with IEC 61000-4-11	0 % U; 1/2 period 0.45,..315° 0 % U; 1 period 70 % U; 25 periods 0 % U; 250 periods	0 % U; 1/2 period 0.45,..315° 0 % U; 1 period 70 % U; 25 periods 0 % U; 250 periods	The quality of the supply voltage should correspond to that of a typical business or hospital environment. The battery life given in the documentation must be respected.
Magnetic field at supply frequency (50/60 Hz) in accordance with IEC 61000-4-8	30 A/m	30 A/m	Magnetic fields in the mains frequency must correspond to the typical values as found in a business or hospital environment.

## Electromagnetic environment – Guidelines

The leon *plus* is intended for operation in the electromagnetic environment given below. The customer or user of the leon *plus* must ensure that the leon *plus* is used in such an environment.

Table 5: Equivalence for protective distance depending on the transmitter frequency

Immunity test	IEC 60601-test level	Compliance level
Conducted HF-interference in accordance with IEC 61000-4-6	3 V <sub>eff</sub> 150 kHz – 80 MHz	3 V <sub>eff</sub> 150 kHz – 80 MHz
	6 V <sub>eff</sub> 150 kHz – 80 MHz within the ISM-bands*	6 V <sub>eff</sub> 150 kHz – 80 MHz within the ISM-bands*
Radiated HF-interference in accordance with IEC 61000-4-3	3 V/m 80 MHz to 2.7 GHz	3 V/m 80 MHz – 2.5 GHz

\*The ISM bands (Industrial, Scientific and Medical bands) between 0.15 MHz and 80 MHz are 6.765 Hz to 6.795 MHz, 13.553 MHz to 13.567 MHz, 26.957 MHz to 27.283 MHz and 40.66 MHz to 40.70 MHz.



The field strength of stationary radio transmitters is for all frequencies in accordance with an examination on site lower than the compliance level.

Interference is possible in the environment of devices that bear this icon.

The field strengths of stationary transmitters, such as the basic stations of radio telephones and mobile landline services, amateur stations, AM and FM radio broadcasting and television transmitters can theoretically not be predetermined precisely. To investigate the electromagnetic environment as a result of stationary HF transmitters, an examination of the site is recommended. If the investigated field strengths at the site of the leon *plus* exceed the compliance level given above, the leon *plus* must be observed with regard to its normal operation at each application location. If unusual performance characteristics are observed, it may be necessary to adopt additional measures, such as a change of direction or positioning the leon *plus* at another site.

Over a frequency area of 150 kHz to 80 MHz, the field strengths must be lower than 10 V/m.

**NOTE:** These guidelines may not apply to every situation. The distribution of electromagnetic variables is influenced by absorption and reflections from buildings, objects and human beings.



Table 6: Test specification for the immunity of coatings to high-frequency wireless communication equipment

Testing frequency MHz	Frequency band* MHz	Radio service <sup>a</sup>	Modulation <sup>b</sup>	Max. output W	Distance m	Immunity test level V/m
385	380 to 390	TETRA 400	Pulse modulation <sup>b</sup> 18 Hz	1.8	0.3	27
450	430 to 470	GMRS 460, FRS 460	FM <sup>c</sup> ± 5 kHz Hub 1 kHz Sinus	2	0.3	28
710	704 to 787	LTE Band 13, 17	Pulse modulation <sup>b</sup> 217 Hz	0.2	0.3	9
745						
780						
810	800 to 960	GSM 800/900, TETRA 800, iDEN 820, CDMA 850, LTE Band 5	Pulse modulation <sup>b</sup> 18 Hz	2	0.3	28
870						
930						
1720	1700 to 1990	GSM 1800; CDMA 1900; GSM 1900; DECT; LTE Band 1, 3, 4, 25; UMTS	Pulse modulation <sup>b</sup> 217 Hz	2	0.3	28
1845						
1970						
2450	2400 to 2570	Bluetooth, WLAN 802.11 b/g/n, RFID 2450, LTE Band 7	Pulse modulation <sup>b</sup> 217 Hz	2	0.3	28
5240	5100 to 5800	WLAN 802.11 a/n	Pulse modulation <sup>b</sup> 217 Hz	0.2	0.3	9
550						
5785						

**NOTE:** If necessary, the distance between the transmitting antenna and the device can be reduced to 1 m to achieve the immunity test level. The 1 m testing distance is approved according to IEC 61000-4-3.

<sup>a</sup> For some radio services, only the frequencies for the radio link from the mobile communication device to the base station have been included in the table.

<sup>b</sup> The carrier must be modulated with a square wave signal with a 50 % duty cycle.

<sup>c</sup> As an alternative to frequency modulation (FM), pulse modulation with a 50% duty cycle at 18 Hz can be used, as this would represent the worst case, if not the actual modulation.

Table 7: Restriction due to the presence of higher EM INTERFERENCES than specified in chapter "Guidelines and manufacturer's declaration - Electromagnetic immunity".

**Oxygen flow under all conditions except oxygen supply failure**

Limitation to be expected by the operator due to the presence of higher EM INTERFERENCES	Exceeding or falling below the values triggers an alarm
--	---

**Supply of a non-hypoxic gas mixture to the patient**

Limitation to be expected by the operator due to the presence of higher EM INTERFERENCES	Exceeding or falling below the set alarm limit triggers an alarm
--	--

**No supply of excessive concentrations of a volatile anaesthetic**

Limitation to be expected by the operator due to the presence of higher EM INTERFERENCES	Exceeding or falling below the set alarm limit triggers an alarm
--	--

**Monitoring the airway pressure**

Limitation to be expected by the operator due to the presence of higher EM INTERFERENCES	Exceeding or falling below the set alarm limit triggers an alarm
--	--

Device description

Overview

Front

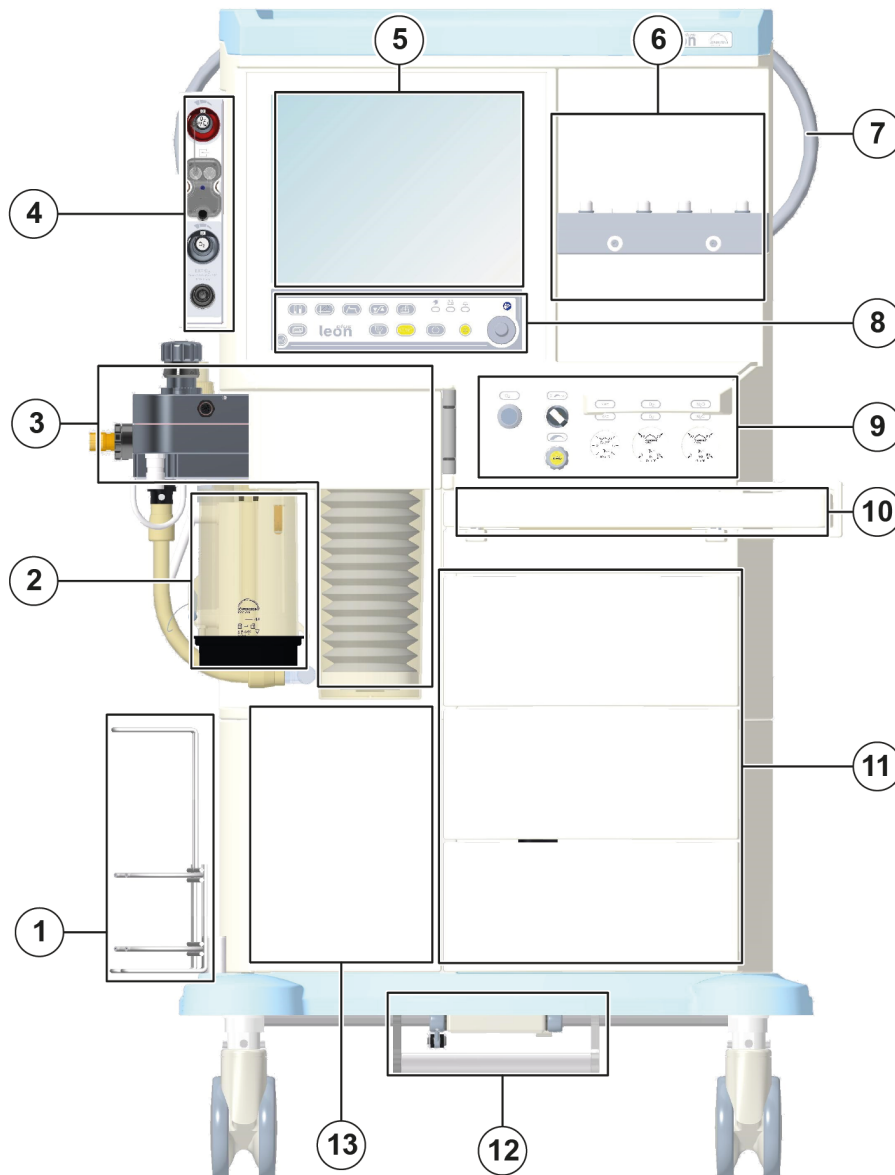

- |                                    |                                  |
|------------------------------------|----------------------------------|
| (1) bronchial aspiration mounting  | (8) keypad with encoder          |
| (2) CO <sub>2</sub> absorber       | (9) display and control elements |
| (3) patient module                 | (10) writing shelf               |
| (4) options board                  | (11) drawers                     |
| (5) 15" touchscreen display        | (12) brakes (optional)           |
| (6) anaesthetic vaporiser mounting | (13) cupboard with drawer        |
| (7) manoeuvring handle             |                                  |

001081

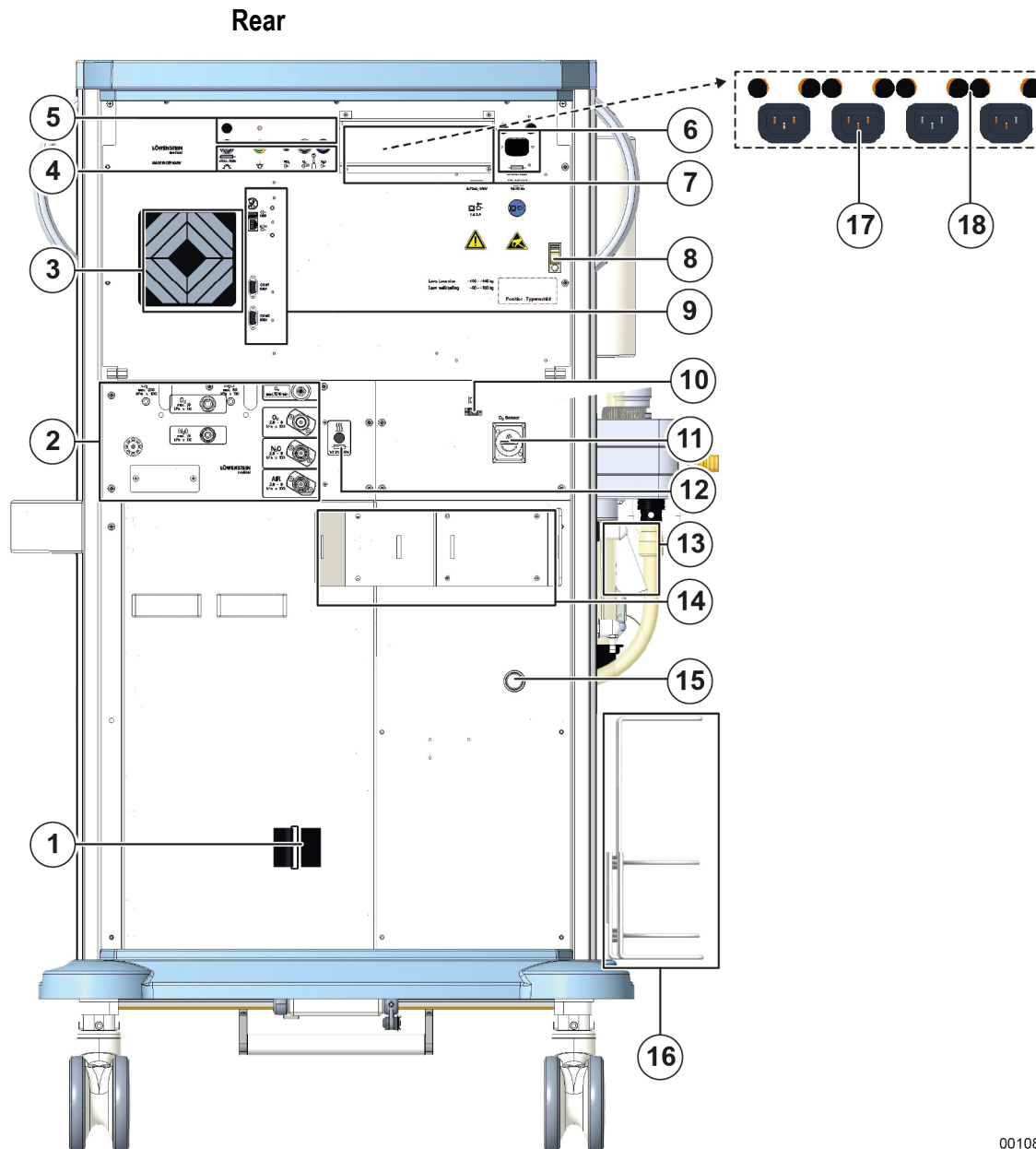

001082

- |  |  |
|--|--|
| <ul style="list-style-type: none"> <li>(1) pressure tube mounting (Velcro fastener)</li> <li>(2) pneumatic connections</li> <li>(3) fans</li> <li>(4) electrical connectors</li> <li>(5) connection for examination lamp with fuse</li> <li>(6) connection and fuse mains cable</li> <li>(7) cover for additional sockets</li> <li>(8) clip for mains cable for additional display</li> <li>(9) data connections</li> <li>(10) FO connection (optional)</li> </ul> | <ul style="list-style-type: none"> <li>(11) O<sub>2</sub> fuel cell (for watertrap variant LM Watertrap with O<sub>2</sub> fuel cell, the O<sub>2</sub> fuel cell is located here)<br/><i>In preparation</i></li> <li>(12) heating fuse</li> <li>(13) patient module locking mechanism</li> <li>(14) 10L cylinder mounting (optional)</li> <li>(15) AGSS connection</li> <li>(16) Bronchial aspiration mounting</li> <li>(17) additional sockets</li> <li>(18) fuses for additional sockets</li> </ul> |
|--|--|

## Patient module

---

- decoupled fresh gas
- brought to the right temperature to avoid the build-up of condensation and to prevent the ventilation gases warming up
- decoupled APL during mechanical ventilation
- one inspiratory and one expiratory flow sensor
- absorber, which can be changed during operation
- fully sterilisable

## Anaesthetic vaporiser mounting

---

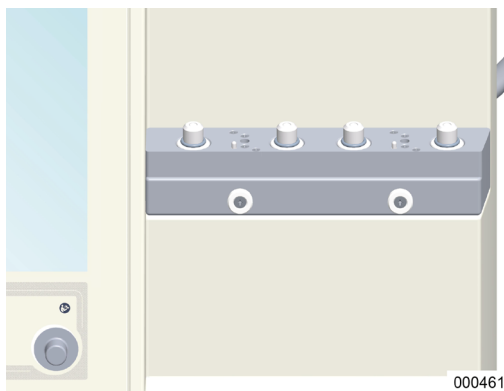

💡 Please also refer to the anaesthetic vaporiser user manual.

(→ "Setting up the anaesthetic vaporiser" p. 90)

## Ventilator

---

- pneumatic drive (O<sub>2</sub> or medical air)
- hanging bellows
- compliance-compensated
- pressure-limited

## Railing system

---

The leon *plus* has a railing system on the right and on the left that can be adapted using accessories, e.g.:

### Device rails

- Max. load: 5 kg
- available in different lengths

### Support arms

- tube support arm
- monitor support arm
- adapter



*Please also refer to the individual user manuals of the adapted systems.*

**!**  
**ATTENTION**

Mounting of over-heavy monitors on the support arms!

#### **Damage to the device through overloading**

- For stability reasons, the total weight of the monitors mounted on the support arm (maximum length: 500 mm) may not exceed 15 kg.

### Lighting

- Workstation light (is switched off when the battery is on)
- Workstation light over writing shelf (is not switched off when the battery is on)

### Shelving

(→ "Mounting additional monitors" p. 288)



*You should also observe the maximum installation height of < 1.80 m (clearance height of doors).*

**!**  
**ATTENTION**

Mounting of over-heavy monitors on the shelving!

#### **Damage to the device through overloading**

- For stability reasons, the total weight of the monitors on the shelving may not exceed 15 kg. The monitors must be secured so that they cannot fall.

## Writing shelf, drawers, storage compartment

---

- storage compartment 31 cm x 20 cm x 28 cm with door
  - pull-out writing shelf (W x D) 43 cm x 30 cm
  - three drawers (H x W x D) 14 cm x 27 cm x 30 cm
- 

Improper loading of the writing shelf!

### **Damage to the device itself and to the writing shelf**

- The total weight to be placed on the writing shelf may not exceed 15 kg.
- 

Improper loading of the drawers!

### **Damage to the device itself and to the drawers**

- The total load in the drawers may not exceed 5 kg.
- 



**ATTENTION**



**ATTENTION**

## Tube and cable guides

### Tube and cable openings

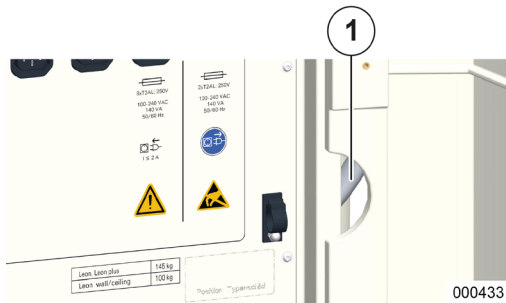

On both sides and on the back there are openings available at the top and bottom through which the cables or tubes can be led outside to the supply connections.

(1) Cable opening, side

### Guide mains table additional monitors

The mains cable of the additional monitors, which are supplied with power from the four auxiliary outlets, can be guided over two clips (right and left in the upper third of the rear wall) through the cable openings out of the device to the monitors.

Before the auxiliary sockets can be used, the socket cover above them must be removed.

💡 *The clip can be jimmied on the upper side with a screwdriver.*

(→ "Rear" p. 30)

(→ "Connection of auxiliary devices" p. 92)

### Tube holder

The Velcro fastener on the lower third of the rear wall of the device allows the pressure tubes to be brought together towards the CGS and guided backwards away from the device. Opening of the rear wall doors by pulling the tubes is prevented.

(→ "Rear wall" p. 63)



## Delivery contents

---

Transportation may only be carried out professionally by a specialist courier or by Löwenstein Medical themselves. Patient part and vapours must be removed from the device before transport and transported separately. The angle of inclination of the device may not exceed 10°.

**The delivery contents (basic equipment) of the leon *plus* include the following items:**

- anaesthesia workstation leon *plus*
  - gas measurement
  - integrated vacuum connector for bronchial aspiration
  - external O<sub>2</sub> outlet
- integrated battery buffering
- rear wall doors, drawers, writing shelf, storage compartment with door
- mains cable

**The following items are not included in the basic equipment:**

- pressure tubes (NIST adapter) in accordance with ISO 32 including supply plug for
  - O<sub>2</sub>
  - N<sub>2</sub>O
  - AIR
- waste hose with coupling and AGSS adapter
- potential equalisation cable
- patient tube system
- bronchial aspiration
- anaesthetic vaporiser

## Operating instructions

<b>Permissible operating staff</b>	<p>The device is operated by a doctor or, on his/her instruction, by a person who is specifically trained and qualified for this task, whereby every user must be introduced to the device and familiar with the user manual and the operation of the device.</p> <p>The user should always stand in front of the device so that all displays are easy to read and all control elements are within easy reach.</p>
<b>Further information</b>	<p>Further information and training is provided for the user. Please contact your Löwenstein Medical sales partner or visit <a href="http://www.loewensteinmedical.de">www.loewensteinmedical.de</a> for more information.</p>
<b>Patient monitoring</b>	<p>The device is equipped with a gas measurement (FiO<sub>2</sub> or O<sub>2</sub>, CO<sub>2</sub>, N<sub>2</sub>O, volatile anaesthetics) as standard. If this measurement is not available or is faulty, the following concentrations at least must be monitored by an external monitor.</p> <ul style="list-style-type: none"><li>▪ O<sub>2</sub> concentration</li><li>▪ anaesthetic gas concentration</li><li>▪ CO<sub>2</sub> concentration</li></ul> <p>Upper and lower alarm limits must be adjustable and in the event of an upper/lower deviation from these limits, an audible alarm must sound.</p> <p>The gas measurement must fulfil the requirements of DIN EN ISO 80601-2-55.</p>
<b>Proper condition</b>	<p>If a fault is established during the self check or the device check, which could jeopardise the patient's safety, the anaesthesia device must not be attached to a patient under any circumstances!</p>
<b>Operating and environmental conditions</b>	<p>The leon <i>plus</i> is only intended for stationary operation.</p> <p>The leon <i>plus</i> can be used near the active equipment of HF SURGICAL DEVICES.</p> <p>The leon <i>plus</i> cannot be used in HF shielded rooms used for magnetic resonance imaging in which high intensity EM INTERFERENCES occur.</p>

## 5. Operating concept

### Function levels

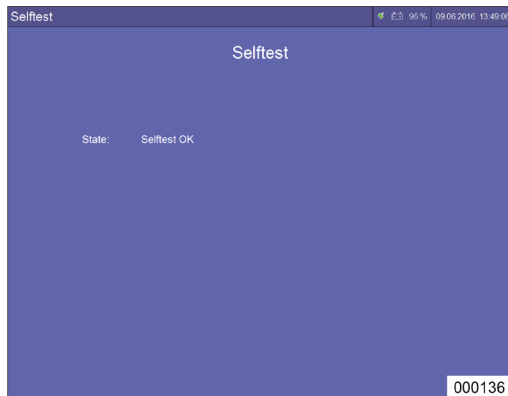

Every time the device is turned on, the boot process of the *leon plus* runs a self test.

💡 *The selftest (starts when the device is turned on) must be carried out once a day.*

The operating concept of the *leon plus* is built on three main levels, which are further divided into sub-levels within which the actual functions ultimately start.

<b>System test</b>	<p>Start of complete system test</p> <p>Start of individual system test blocks</p> <p>incl. FiO<sub>2</sub> calibration (for option "external O<sub>2</sub> fuel cells" only)</p> <p>skip the system test (not recommended)</p> <p>--&gt; Quick start</p>	
<b>Standby</b>	<p>Selection of patient category</p> <p>Selection of tab</p> <p>Selection of a form of ventilation with the corresponding ventilation parameters</p> <p>Display of alarm limits and gas supply pressures</p> <p>Stopwatch</p> <p>Reset to default settings</p> <p>System test</p>	<p>Child Adult IBW</p> <p>Standby Trend charts Tabular trend Event log Extras</p> <p>Config Volume System time Option</p>
<b>Ventilation level</b>	<p>Selection of tab</p> <p>Selection of a form of ventilation with the corresponding ventilation parameters</p> <p>Fresh gas settings</p> <p>Selection of monitoring values page 1/2</p> <p>Display of gas measurement measured values</p> <p>Display of alarm limits and gas supply pressures</p> <p>Stopwatch</p>	<p>Real-time curves Trend curves Tabular trend Alarm log Extras</p> <p>Config Volume Option</p>

Icons

Table 8: Icons/Labels













	Warning of a danger point
	Warning of electrical voltage
	Electrostatically endangered components
	Charging of mobile phones, Smartphones, tablets prohibited
	Pushing or leaning on the device is prohibited
	Device may only be moved in the transport position.
	Follow the instructions
	Unplug from mains before opening
	Type B applied part (applied part for use on the body, but not on an open heart)
	Non-ionised electromagnetic radiation
	Icon for the separated collection of electrical and electronic devices
	CE with ID number of the notified body – confirmation of fulfilment of EU requirements

Table 8: Icons/Labels





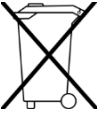







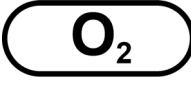

	Date of manufacture
	Heating
	Equipotential
	Fuse
	Manometer for O <sub>2</sub> reserve gas cylinder pressure
	Manometer for N <sub>2</sub> O reserve gas cylinder pressure
	Manometer for vacuum pressure
	Suction switch – adjustable to: <ul style="list-style-type: none"> <li>▪ 0 = Off</li> <li>▪ adjustable</li> <li>▪ max</li> </ul>
	Change a value by turning
	Change a value in stages by turning
	Button for O <sub>2</sub> flush (on the front)
	Outlet (pneumatic)
	Inlet (pneumatic)
	Outlet (for energy and signals)

Table 8: Icons/Labels



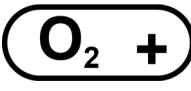





	Inlet (for energy and signals)	
	Inlet/outlet (for energy and signals)	
	Block, general	
	Unblock, general	
<b>EXT O<sub>2</sub></b>	External O <sub>2</sub> outlet	
<b>EXT FG</b> P <sub>max</sub> = 1,2 kPa x 100	External fresh gas outlet giving maximum P <sub>max</sub> pressure	
	Ethernet port	
COM 1  O O	COM 2  O O	1st and 2nd Serial port
	FO outlet (additional monitor)	
USB 	USB port	
	Lamp; light; lighting	
	Auxiliary sockets charge with max. 2 A	
	Connection for high-pressure sensors	
<b>O<sub>2</sub> Sensor</b>	O <sub>2</sub> fuel cell LM Watertrap ( <i>in preparation</i> )	

Table 9: Icons/buttons





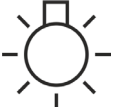





	ON/OFF button																																																	
	Selection button fresh gas blender window																																																	
	Selection button real-time charts window																																																	
	Selection button form of ventilation, ventilation parameters window																																																	
	Selection button MAN/SPONT (manual ventilation/spontaneous breathing) form of ventilation																																																	
	Selection button open forward/focus loops window																																																	
	Selection button alarm limits window																																																	
	<p>Button for switching between the following windows</p> <table border="0"> <thead> <tr> <th colspan="4"><b>on standby</b></th> <th colspan="3"><b>during a ventilation procedure</b></th> </tr> </thead> <tbody> <tr> <td>Standby</td> <td></td> <td></td> <td></td> <td>Real-time curves</td> <td></td> <td></td> </tr> <tr> <td>Trend curves</td> <td></td> <td></td> <td></td> <td>Trend curves</td> <td></td> <td></td> </tr> <tr> <td>Tabular trend</td> <td></td> <td></td> <td></td> <td>Tabular trend</td> <td></td> <td></td> </tr> <tr> <td>Event log</td> <td></td> <td></td> <td></td> <td>Alarm log</td> <td></td> <td></td> </tr> <tr> <td>Extras</td> <td></td> <td></td> <td></td> <td>Extras</td> <td></td> <td></td> </tr> <tr> <td>Config</td> <td>Volume</td> <td>System time</td> <td>Option</td> <td>Config</td> <td>Volume</td> <td>Option</td> </tr> </tbody> </table>	<b>on standby</b>				<b>during a ventilation procedure</b>			Standby				Real-time curves			Trend curves				Trend curves			Tabular trend				Tabular trend			Event log				Alarm log			Extras				Extras			Config	Volume	System time	Option	Config	Volume	Option
<b>on standby</b>				<b>during a ventilation procedure</b>																																														
Standby				Real-time curves																																														
Trend curves				Trend curves																																														
Tabular trend				Tabular trend																																														
Event log				Alarm log																																														
Extras				Extras																																														
Config	Volume	System time	Option	Config	Volume	Option																																												
	Button to start ventilation																																																	
	Standby button (stop ventilation and change to standby)																																																	
	Mute alarm for two or ten minutes button (10 minutes only in MAN/SPONT)																																																	



Table 10: Icons/LEDs



	LED mains voltage available (green light)
	LED battery operation (yellow light)
	LED visual alarm display (red light)

Table 11: Icons/screen (display only)











 <b>50 min.</b>	Screen icon/display: Remaining battery life
 <b>70 %</b>	Screen icon/display: Battery charging control display
 <b>10 min.</b>	Screen icon/display: Battery low
 <b>0 min.</b>	Screen icon/display: Battery failure
	Screen icon/display: No batteries available
	Screen icon/display: Mains voltage available
	Screen icon/display: Mains voltage not available
	Screen icon/display: Upper and lower alarm limits
	Screen icon/display: CGS pressures
	Screen icon/display: 10 L bottle pressures

Table 12: Icons/screen (control elements)







	Screen icon/control element of real-time charts <ul style="list-style-type: none"> <li>▪ 0 point shift</li> <li>▪ Zoom in Y direction</li> <li>▪ Autoscale ON/OFF</li> </ul>
	Screen icon/control element: Number of real-time charts that should be displayed
	Screen icon/control element: Scaling of X-axis
	Screen icon/control element: Selection of which measured value should be displayed as the real-time curve
	Screen icon/control element: Display loop window in full screen
	Screen icon/control element: Set limit values (alarm limits)
	Screen icon/control element: Determine monitor value

Table 13: Icons/screen (buttons)

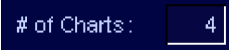

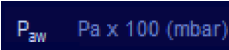



	Button Zoom loop in X direction
	Button Shift 0 point in X direction
	Button Zoom loop in Y direction
	Button Shift 0 point in Y direction
	Button Autoscale loops ON
	Button Autoscale loops OFF
	Close window button

Table 13: Icons/screen (buttons)













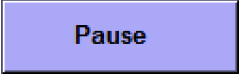
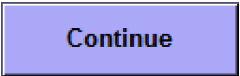
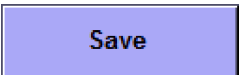
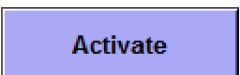
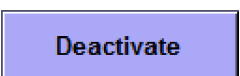

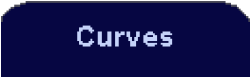
	Button Scroll list
	Button Scroll list (fast)
	Adapt alarm button automatically
	Freeze loop
	Start loop
	Save loop as reference loop
	Display reference loop and start current loop (activate comparison mode)
	Delete reference loop and start current loop (deactivate comparison mode)

Table 14: Icons/screen (tabs)

	on standby				during a ventilation procedure		
	Standby window (dark blue when active)				Real-time curve window (dark blue when active)		
							
	Trend curve window						
	Tabular trend window						
	Event Log				Alarm Log		
							
	Extras						
	Config	Volume	System time	Option	Config	Volume	Option
							
							
							
	Monitoring values page 1 or 2						
	Tab with further pages						

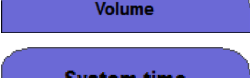
## User interface

The user interface of the *leon plus* consists of three components:

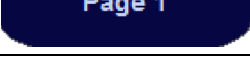
- screen (TFT) with touchscreen (touch)
- keypad
- rotary switch (encoder)

The main control element is the touchscreen, but the device can also be fully operated by the keypad and rotary switch.

## Concepts

---

### Safety concept

#### Modules

In the *leon plus* the ventilation unit, user interface and monitoring system are separate, independent modules. If the ventilation unit fails, this does not lead to a limitation in the functioning of other modules. Manual ventilation with full monitoring scope is then possible.

If the user interface and the monitoring system fail, the ventilation procedure continues to run using the last fresh gas settings and ventilation parameters set.

#### User interface

One function only is allocated to each control element. Any device function can also be accessed and carried out using the keypad buttons and the rotary switch. A faulty touchscreen does not lead to functionality limitations.

### Colour concept

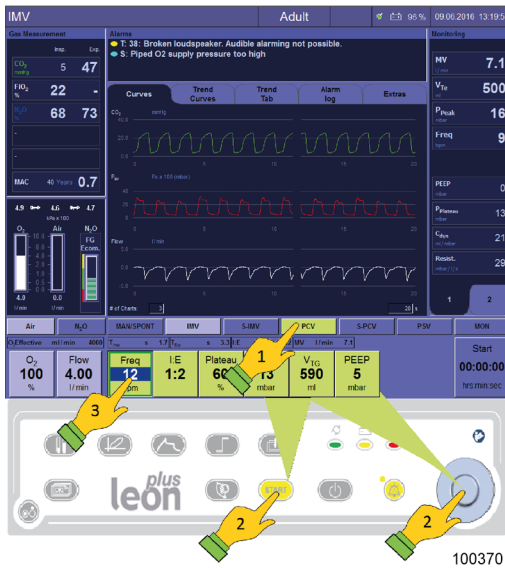

The outline of an active window is pale blue; the outline of an inactive window is dark blue.

(→ "Touchscreen" p. 49)

The button of the active form of ventilation (IMV here) is displayed in pale blue. A newly selected breathing type (PCV here) and its buttons for setting the ventilation parameters are yellow (1).

When selecting a new form of ventilation, its buttons for presetting the ventilation parameters are shown above the buttons of the active form of ventilation. The newly selected form of ventilation can be started by the yellow "START" button on the keypad or by the rotary switch (2).

If a ventilation parameter unlocks, the button is outlined in green and the value to be entered is highlighted in dark blue (3).

If not confirmed, the form of ventilation presets (yellow) are closed again after 10 seconds and the previous active form of ventilation and its parameters are retained.

(→ "Control element functions" p. 50)

### Keypad

#### Operation of keypad



Various functions are carried out using the keypad (→ "Table 9: Icons/buttons" p. 42)

Operating states are visualised through LEDs.

(→ "Table 10: Icons/LEDs" p. 43)

## Touchscreen

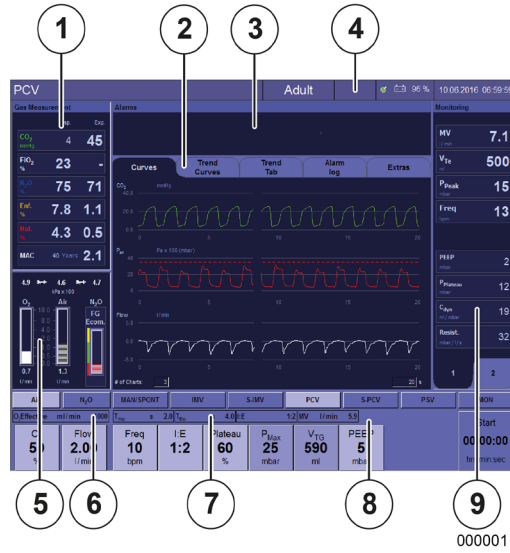

### Basic screen

The basic information and control elements are displayed on the screen with a title bar and eight windows.

- (1) Display of gas measurement measured values
- (2) Tab system
- (3) Display of current alarms  
(→ "Display of current alarms" p. 200)
- (4) Title bar
- (5) Operation and display of the fresh gas blender
- (6) Display of effective O<sub>2</sub> shortage
- (7) display T<sub>insp.</sub>, T<sub>exp.</sub>, I:E
- (8) Setting and display of ventilation types and ventilation parameters
- (9) Display of ventilation measured value



### Extended monitor

If desired, two further windows can be shown.

- (1) Show window for loops with the **loop window** button
- (2) Show window for limit values (alarm limits) with the **alarm limits window** button
- (3) Show display pressures CGS and 10 L bottles with the **alarm limits window** button













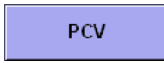

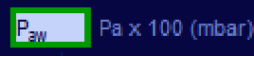
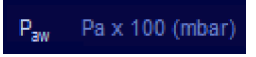

## Touchscreen operation

The device functions are operated primarily via the touch screen. The following functions, however, can be carried out via the keypad only:

- ON/OFF button
- Show loop window button
- Show alarm limits, display pressures CGS, 10 L bottles window
- Button for switching between screens
- Start ventilation button
- Standby button, stop ventilation and change to standby
- Mute alarm for two or ten minutes button (10 minutes only in MAN/SPONT)

💡 (→ "Table 9: Icons/buttons" p. 42)

Table 15: Control element functions (touchscreen)

control element			
<b>preset</b>	<b>selected</b>	<b>active</b>	By touching a <b>button with a function</b> (e.g. selection of a form of ventilation), it unlocks independently and is outlined in green.
			
			A <b>setting value</b> (e.g. ventilation parameter) is unlocked, outlined in green and the value to be entered is highlighted in blue (change is possible only with the rotary switch).
			An <b>icon with a function</b> (e.g. control element of real-time charts) is outlined in green in a window and highlighted in pale blue.
			
		 	A tab is highlighted in dark blue.
			Scrolling data in the window slow/fast close open window



## Rotary switch

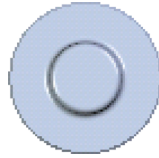

The button is turned for selection; press the rotary switch for confirmation:

- The rotary switch enables you to move to a button or a window
- The rotary switch confirms a **button with a function**
- This **setting value** is changed and confirmed via the rotary switch or by pressing the button again.
- The rotary switch confirms an **icon with a function**
- **A form of ventilation can be started** via the rotary switch

### Operation using the keypad exclusively



Without using the touchscreen, a button must be first of all focused on the relevant window through the keypad.

(→ "Operation of keypad" p. 48)

The shifting of the input focus to a button is carried out inside a window by turning the rotary switch.

A ventilation parameter is unlocked by pressing the rotary switch, changed by turning and confirmed by pressing once more.

000373

## Tab system

The centrally arranged window in the centre of the user interface consists of five tabs, which are partially assigned to different functions when on standby and during an ongoing ventilation procedure. The active tab is highlighted in dark blue.

### Tab bar during ventilation



### Tab bar in standby



### Tab bar extras during ventilation



### Tab bar extras in standby



## Title bar

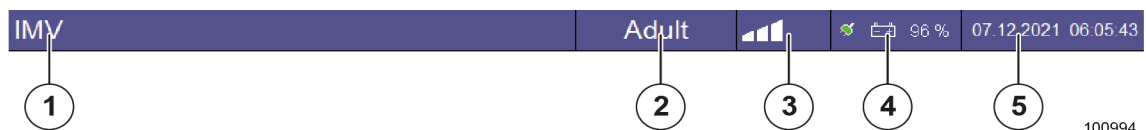

- (1) active form of ventilation
- (2) patient category or "weight" lettering if selected
- (3) alarm mute state or display of alarm setting according to environment volume (quiet, medium, loud) if no alarm suppressed
- (4) state of electricity supply and rechargeable batteries
- (5) date, time

## HLM form of ventilation

---



The HLM form of ventilation is re-displayed explicitly in red in the title bar during ventilation, as the monitoring of all limit values (outside of CPAP) is turned off.



**WARNING**

Alarms switched off!

### **Risk of oxygen deficiency**

- Be extra vigilant during the ventilation.

## MON form of ventilation

---



The MON form of ventilation is re-displayed explicitly in red in the title bar during ventilation, as the monitoring of all limit values (outside of CPAP) is turned off.



**WARNING**

Alarms switched off!

### **Risk of oxygen deficiency**

- Be extra vigilant during the ventilation.



*In the MON form of ventilation, fresh gas administration is switched off.*

## Monitoring of muting of alarm

---

### Mute 2 min.



The **Mute** button is positioned on the bottom right of the keypad. By pressing **Mute**, the audible alarm for all currently pending alarms is muted for two minutes.



A minute counter appears in the title bar in mm:ss format, which displays the remaining mute time.

(→ "Alarm muting 2 minutes" p. 204)

### Mute 10 min.



In the **MAN/SPONT** form of ventilation, a screen dialogue appears if the **Mute** button is pressed for longer than 2 seconds.

(→ "10 minute alarm muting" p. 205).

If the dialogue is confirmed with **Yes**, all alarms are muted for 10 minutes. A minute counter appears in the title bar in mm:ss format, highlighted in red, which displays the remaining mute time.

 *The **Mute 10 min.** function is only available in the **MAN/SPONT** form of ventilation.*



### WARNING

---

Alarms muted!

#### Risk of oxygen deficiency

Any alarms that occur are only displayed visually.

- Watch the ventilation, while the alarms are muted.

---

 *This function should only be used when patients are disconnected from the device.*

## Screensaver

---

A screensaver can be set up in the configuration menu.

 *It should only be set up by trained specialist staff or by Löwenstein Medical-authorised service technicians.*

## Control elements and displays

### Front

#### O<sub>2</sub>, flush, vacuum, manometers

Display and control elements are displayed on the right above the drawer block on the front:

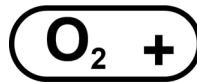
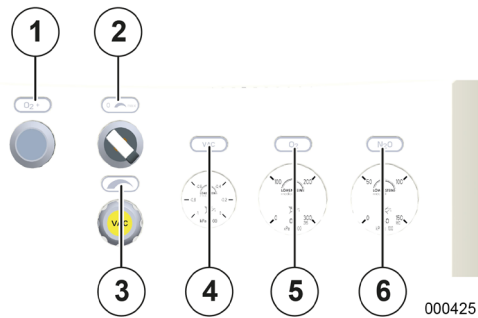

(1) Button for O<sub>2</sub> flush (≥ 35 l/min)



(2) Switch for aspiration – adjustable to:  
– 0 = Off  
– adjustable  
– max



(3) Rotary switch for vacuum dosage (turn anticlockwise to increase the vacuum)



(4) Manometer for vacuum pressure

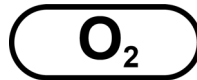

(5) Manometer for O<sub>2</sub> bottle pressure



(6) Manometer for N<sub>2</sub>O bottle pressure

**Variants**



Display and control elements on the front, O<sub>2</sub> reserve gas bottle operation only

000426



Display and control elements on the front, without reserve gas bottle operation

000427



Display and control elements on the front, without reserve gas bottle operation without integrated bronchial aspirator

000120

**Production and dosage of the vacuum**

The vacuum can be turned on and off via a switch. The strength can be regulated between 0 and -0.7 bar.



The switch has three settings:

- off
- regulated value
- max

If the max setting is selected, it switches immediately to maximum aspiration performance, without the regulating valve having to be fully turned on.

There are two variants for producing the vacuum for the bronchial aspirator:



- injector principle



- vacuum (wall connection)



## Options board

The options board is situated on the top of the left side wall of the device.

### Option panel for variant LM Watertrap



- (1) O<sub>2</sub> emergency dosing (red ring)
- (2) Watertrap
- (3) Flowmeter for external O<sub>2</sub> outlet
- (4) External O<sub>2</sub> outlet; ISO cone 22 mm outside, 15 mm inside

The “LM Watertrap” variant consists of a container with a permanently connected gas measurement tube.

### Option panel for variant DRYLINE™ watertrap

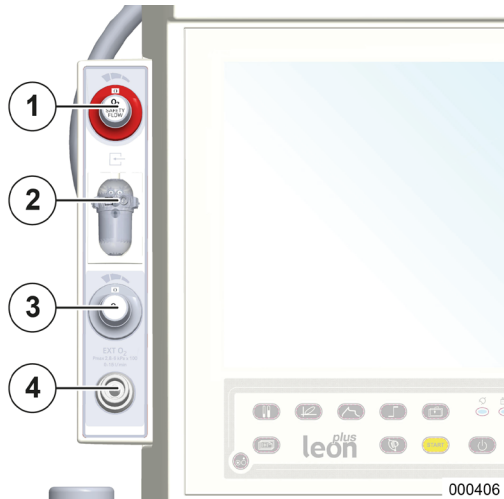

- (1) O<sub>2</sub> emergency dosing (red ring)
- (2) Watertrap
- (3) Flowmeter for external O<sub>2</sub> outlet
- (4) External O<sub>2</sub> outlet; ISO cone 22 mm outside, 15 mm inside

The “DRYLINE™ watertrap” variant consists of a container with a removable lid and removable gas measurement tube.

**External fresh gas outlet options board version**

- (1) Switch for external fresh gas outlet 1/0 (On/Off); displayed setting is 0 → Off
- (2) External fresh gas outlet; ISO cone 22 mm outside, 15 mm inside

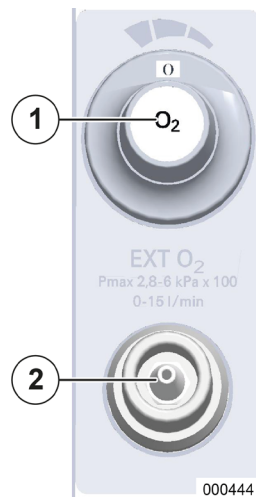
**External O<sub>2</sub> outlet options board version**

- (1) Flowmeter for external O<sub>2</sub> outlet
- (2) External O<sub>2</sub> outlet; ISO cone 22 mm outside, 15 mm inside



## Device connections

### Description of device connections

#### External O<sub>2</sub> outlet



- (1) flowmeter for external O<sub>2</sub> outlet
- (2) external O<sub>2</sub> outlet: ISO cone, 22 mm outside, 15 mm inside

The dosage and closing (OFF) of the external O<sub>2</sub> outlet is carried out by the flowmeter.

**💡** The gas from the O<sub>2</sub> fresh gas outlet consists of 100% O<sub>2</sub>.

#### External fresh gas outlet

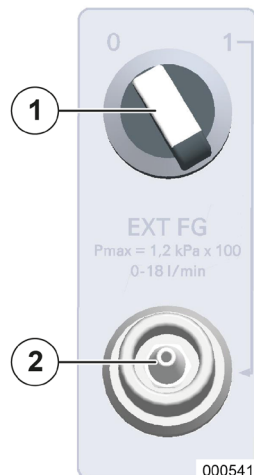

- (1) Switch for fresh gas outlet 1/0; displayed setting is 0 → OFF
- (2) Fresh gas outlet: ISO cone, 22 mm outside, 15 mm inside

The maximum pressure on the external fresh gas outlet is given with  $P_{\max} = 1,2 \text{ kPa} \times 100$ .

The external fresh gas outlet serves as the connection to semi-opened systems e.g.

- Bain
- Jackson Rees systems

**💡** The concentrations of gases from the fresh gas outlet are set as follows: Narcotic gases on the anaesthetic vaporiser; O<sub>2</sub>, N<sub>2</sub>O, AIR on the fresh gas blender

## Operation of the device connections

### External O<sub>2</sub> outlet

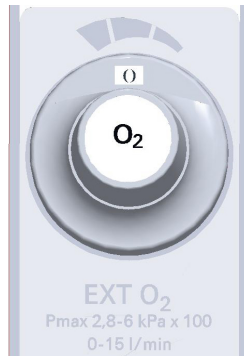

The flowmeter for the external O<sub>2</sub> outlet has a setting range of 0 (OFF) – 15 l/min. Setting values are: 0, 1, 2, 3, 4, 5, 6, 9, 12, 15 l/min.

The external O<sub>2</sub> outlet can be used for O<sub>2</sub> insufflation during local anaesthesia, for example.

*Take care that the set flow can be seen in the display window of the flowmeter and the switch is not in an intermediate position.*

💡 *Depending on the version of the flow meter, no gas flows in the intermediate position, or less than 50 % of the adjacent higher setting.*

### External fresh gas outlet



The fresh gas outlet has two switch positions; the position shown is 0 → OFF.

#### Switch positions:

1 → ON → fresh gas flows towards the external outlet

0 → OFF → fresh gas flows into the patient module

### Operation of emergency O<sub>2</sub> dosing

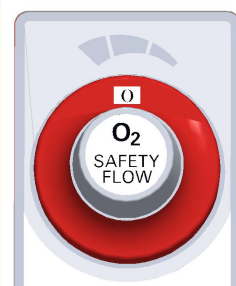

The O<sub>2</sub> emergency dosing is located on top in the option panel. It is marked by a red ring. It is a flowmeter with a setting range of 0 (OFF) – 15 l/min. Setting values are: 0, 4, 5, 6, 7, 8, 9, 10, 12, 15 l/min.

The O<sub>2</sub> emergency dosing is only released during the ongoing system test and not released during an ongoing ventilation.

💡 *Take care that the set flow can be seen in the display window of the flowmeter and the switch is not in an intermediate position.*

💡 *Depending on the version of the flowmeter, no gas flows in the intermediate position, or less than 50 % of the adjacent higher setting.*

## Gas measurement

The *leon plus* is equipped with a sidestream measurement as standard. An  $\text{FiO}_2$  meter is optional. The corresponding configuration occurs in servicing and may only be carried out by Löwenstein Medical-authorized service technicians.

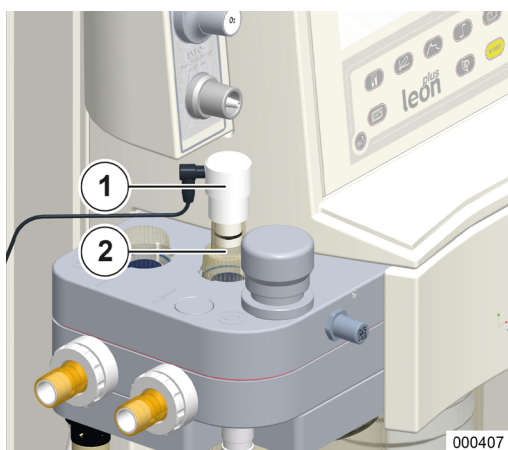

### **FiO<sub>2</sub> meter**

(only possible for the "external O<sub>2</sub> fuel cells" option)

The  $\text{FiO}_2$  meter sensor is situated in an adapter, which replaces the inspiratory inspection glass from the patient module. Only the inspiratory O<sub>2</sub> concentrations are measured.

- (1)  $\text{FiO}_2$  sensor
- (2) adapter

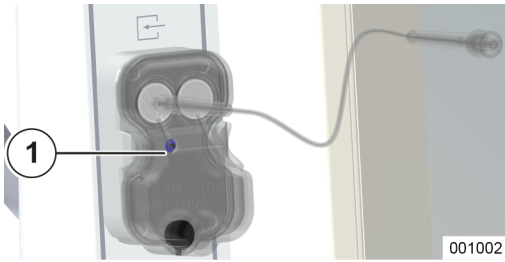
**Sidestream measurement (LM Watertrap)**

The variant "LM Watertrap" with permanently connected gas measurement tube is situated in the option panel.

(1) LM Watertrap

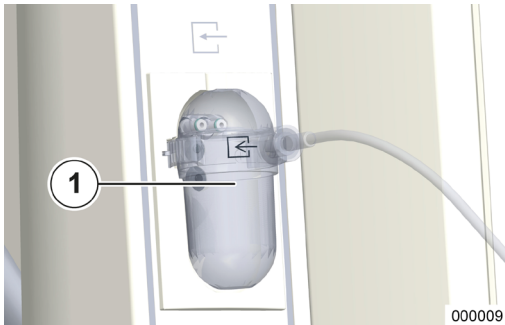
**Sidestream measurement (DRYLINE™ watertrap)**

The variant DRYLINE™ watertrap with a luer lock for the sample line is situated on the option panel.

(1) DRYLINE™ watertrap

(→ "Gas measurement maintenance (sidestream measurement)" p. 263)

- 💡 *If the leon plus is on standby, the gas measurement runs independently of the screensaver configuration for another 20 to 90 minutes. After this, it too switches to standby. If a button or the touchscreen is used, the gas measurement goes back into operation. The display is then delayed briefly.*
- 💡 *The device may only be operated with one of the two watertrap variants.*

## Rear wall

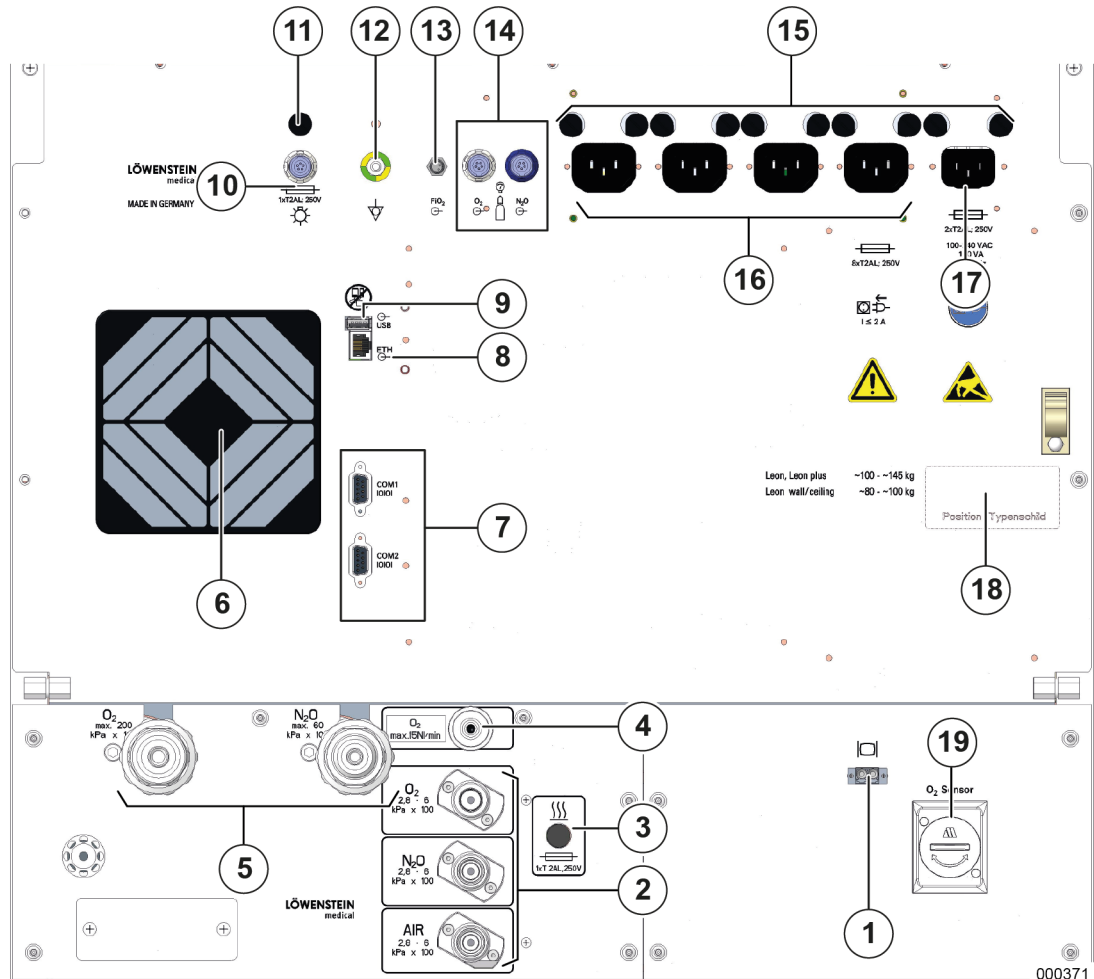

- |   |   |
|---|---|
| <ul style="list-style-type: none"> <li>(1) FO connection (LC socket) optional</li> <li>(2) Connections for CGS</li> <li>(3) Patient module heating fuse</li> <li>(4) Vacuum or O<sub>2</sub> high-pressure outlet</li> <li>(5) Reserve gas cylinder connection</li> <li>(6) Fans</li> <li>(7) 2 x D-sub, 9-pin socket, serial connection</li> <li>(8) 1 x RJ 45 Ethernet connection</li> <li>(9) 1 x USB connection (covered, for service purposes only)</li> <li>(10) Workstation illumination connection</li> <li>(11) Workstation light connection fuse</li> <li>(12) Connection for potential equalisation</li> </ul> | <ul style="list-style-type: none"> <li>(13) Socket for FiO<sub>2</sub> meter (for "external O<sub>2</sub> fuel cells" option only)</li> <li>(14) Pressure sensor inlets for 10 l cylinders: socket coded with white ring: O<sub>2</sub> pressure sensor; socket coded with black or blue ring: AIR or N<sub>2</sub>O pressure sensor</li> <li>(15) Mains connection and auxiliary power point fuses</li> <li>(16) four auxiliary sockets (here without socket cover)</li> <li>(17) Mains: 100–240 VAC</li> <li>(18) Type plate</li> <li>(19) O<sub>2</sub> Sensor gas measurement LM Watertrap (<i>in preparation</i>)</li> </ul> |
|---|---|

## Patient module



Improper loading of the patient module!

### Damage to the device itself and to the patient module

Do not load the patient module improperly on the docking station:

- do not lean on it
- do not use the APL valve as a manoeuvring handle
- do not handle the device with the docking station open
- avoid loading by moving the operating table up and down

## Removing the patient module

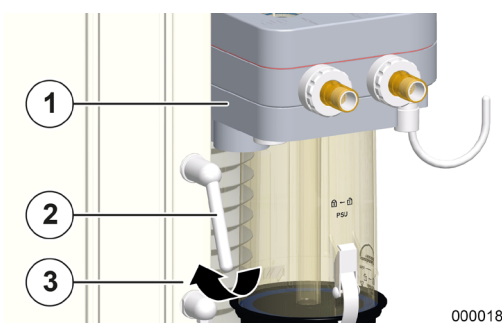

To remove the patient module from the device, the docking station must first be unlocked by turning the lever towards anticlockwise (or back).

- (1) Docking station
- (2) Lever for locking the docking station to the patient module on the device
- (3) Open in the direction of the arrow

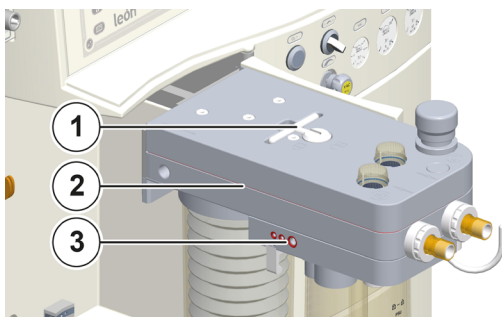

After unlocking, the docking station can be swivelled forwards to the side. The illustration shows the catch in locked position (lying at an angle to the longitudinal axis of the patient module).

- (1) Fold-out handle of the catch
- (2) Patient module in folded-out position
- (3) O rings
- (4) Handle in vertical position

*The patient module cannot be lifted off the docking station without removing the CO<sub>2</sub> absorber.*

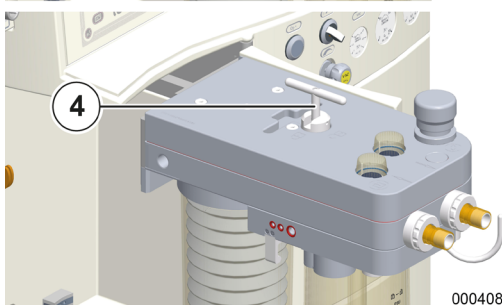

1. Turn the handle of the catch up into vertical position. Turning anticlockwise releases the link, while pressing down and turning clockwise closes the link to the docking station.
2. Lift off the patient module vertically upwards.



Docking station locked incorrectly!

### Damage to the device itself and to the patient module

- Before locking the docking station, it is vital to ensure that the docking station and the patient module are swivelled in fully.

**!**  
**ATTENTION**

Patient module inserted incorrectly!

**Damage to the device itself and to the patient module**

- The housing can be damaged if the handle of the catch is not shut when the patient module is shut.

**Connection for ventilation tubes, anaesthesia gas scavenging system and ventilation bag**

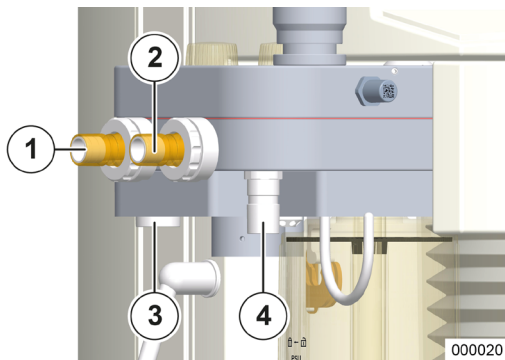

- (1) Patient expiration connection cone (Ø 22 mm)
- (2) Patient expiration connection cone (Ø 22 mm)
- (3) AGSS connection cone (Ø 30 mm)
- (4) AGSS connection cone (Ø 22 mm)

**Connection of the AGSS on the rear of the device**

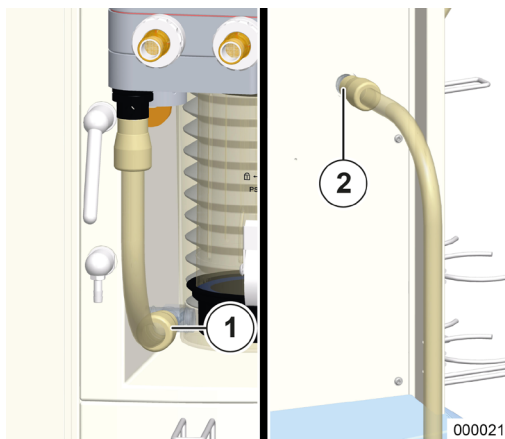

- (1) AGSS connection on the front of the casing (Ø 22 mm)
- (2) AGSS connection on the front of the casing (Ø 22 mm)

**💡** Please also refer to the AGSS user manual.

**Connection for respiratory bellows, dome and CO<sub>2</sub> absorber, PEEP valve diaphragm cover, flow sensors**

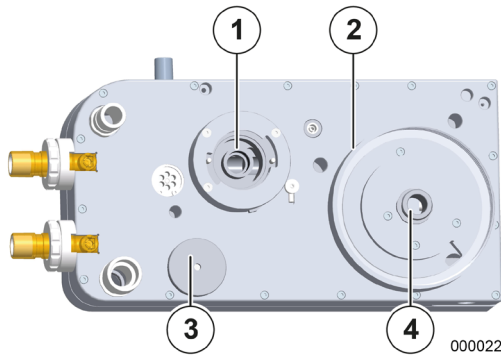

- (1) Carrier CO<sub>2</sub> absorber
- (2) Carrier dome
- (3) PEEP valve diaphragm cover
- (4) Respiratory bellows connection

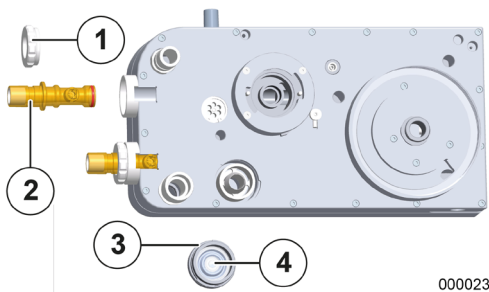

- (1) Lock nut
- (2) Flow sensor
- (3) PEEP valve diaphragm cover
- (4) PEEP valve diaphragm

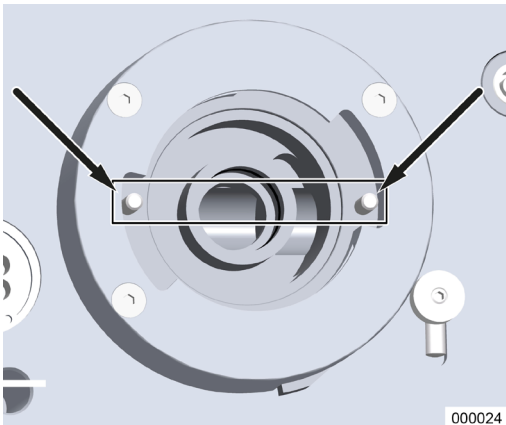

Without the CO<sub>2</sub> absorber, the two pins must be in place as shown in the illustration.



### APL valve

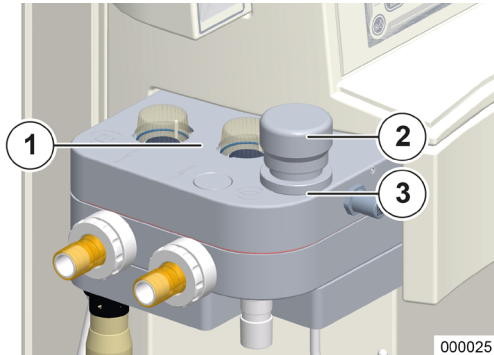

The ventilation pressure during the MAN/SPONT, HLM and MON forms of ventilation is limited by the APL valve (adjustable pressure limitation), which can be set manually between the two end positions SP (spontaneous breathing fully opened) and a maximum setting.

The pressure limit is increased by turning the valve head to the right and decreased by turning it to the left, whereby engagement is noticeable from 40 Pa × 100 (mbar). The marked settings are SP (spontaneous), 10, 20, 30, 50, 70, max. setting.



APL with quick exhaust  
(Lifting the valve head)

There are 2 APL variants:

- APL without quick exhaust
  - max. setting 90 Pa × 100 (mbar)
- APL with quick exhaust
  - max. setting 80 Pa × 100 (mbar)
  - the ventilation system is vented by lifting the valve head

- (1) Inspiratory and expiratory valve diaphragm of sight glasses
- (2) APL with valve head
- (3) APL locking mechanism (bayonet catch)

### Bronchial aspiration

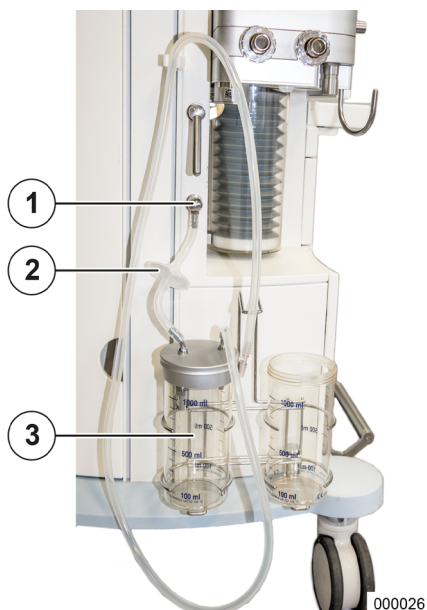

There are two variants for producing the vacuum:

- injector principal
- vacuum wall connection

💡 *Please also refer to the bronchial aspiration user manual.*

- (1) Vacuum connection for bronchial aspiration
- (2) filter
- (3) Bronchial aspiration glass

## 6. Preparations

### First installation

-  *You should refer to a service technician authorised by Löwenstein Medical for this first installation.*

### Adaptation to ambient conditions

If the *leon plus* is subject to extreme ambient conditions (temperature, moisture) during transport or storage, give the device, while switched off, the opportunity to adapt to the conditions at the installation site. Connect the device as soon as possible to the mains supply.

-  *Before the first start-up, the *leon plus*, should be cleaned as described in the "Work instructions for hygienic preparation".*

## Customer requirements at the application site (leon *plus* – Standard configuration)

**WARNING**

Class I device!

**Risk of injury through electrocution.**

- The mains to which the device is connected must be earthed.

Table 16: Requirements at the application site (leon *plus* default configuration)

Voltage	Supply	100-240 V <sub>AC</sub> , 50/60 Hz The maximum internal resistance may not lead to an upper/lower deviation of the supply voltage of 240 V <sub>AC</sub> + 10 % or 100 V <sub>AC</sub> - 10 % at the mains socket.
	Wall connection	in accordance with EN 60601-1 for earthed devices (Schuko plug)
Potential equalisation	Wall connection	for POAG-KBT6DIN socket in accordance with DIN42801
CGS	Pressure	2.8–6.0 kPa × 100 (bar)
	Wall connection	for supply plug DIN 13260–2 shape-coded with Ø 7.5 mm connecting nipple
	Gas quality	dry, oil and particle-free (medical)
Waste disposal system (AGSS)	Aspiration performance	55–60 l/min
	Wall connection	in accordance with EN 737
Climatic conditions		Temperature, humidity, ambient pressure (→ "Technical data" p. 320) sufficient ventilation
Additional monitors		Observe max. current consumption (inrush current) (→ "Connection of auxiliary devices" p. 92) and weight (→ "Mounting additional monitors" p. 288)

## Emergency power supply

---

 *When selecting the installation site, take care that access to the mains plug is always guaranteed. The device must be able to be separated from the mains easily and at any time.*

The leon *plus* has an uninterrupted power supply, which in the event of voltage variations in the mains current or total power failure maintains the operational readiness or operation of the device. Independent of the setting of the ventilation parameters, battery operation of at least 100 minutes is guaranteed.

## Charging batteries

---

The leon *plus* has two emergency power batteries. Connect the leon *plus* to a suitable mains socket via a mains cable. The device recognises the voltage 100–240 V<sub>AC</sub>, 50/60 Hz automatically. A manual switch-over is not necessary. For the batteries to fully charge before first operation and after replacement, the device must be connected to the mains for at least 8 hours. If the mains plug is plugged in, the batteries charge automatically. The batteries charge even if the device is turned off.

## Out-of-operation for a longer period

---



If the leon *plus* is not used for a longer period, it should remain plugged into the mains to avoid the batteries discharging.

The green LED below the plug icon on the keypad shows that mains voltage is available.

## Preparation for start-up

**Gas connections****WARNING**

Bottle valves, high pressure regulator and connected fittings!

**Explosion risk**

- Use the correct pressure reducer  
(CGS = 2.8–6.0 kPa × 100 (bar), Reserve = 1.8–2.0 kPa × 100 (bar))
- Do not use any kind of tool to open the bottle valves.
- Oil and fats can react violently with some gases under pressure (O<sub>2</sub>, N<sub>2</sub>O (laughing gas), compressed air and their mixtures).
  - Do not grease or oil the connections for reserve gas bottles and 10 L bottles.
  - Avoid contact between hand cream and the fittings.

**Operation with reserve gas bottles and/or 10 L bottles****Starting up reserve gas cylinders and 10 L gas cylinders**

1. Open the valve of the gas cylinder slowly.

 *Ensure proper use with the patient in mind. If no gas is removed, close the valve of the gas cylinder.*

**Decommissioning reserve gas cylinders and 10 L gas cylinders****When changing the gas cylinder or the high pressure regulator:**

1. Open the valve of the gas cylinder.
2. Use up or bleed the remaining gas in the high pressure regulator and in the tube pipe.

**ATTENTION**

Do not unscrew the high pressure regulator while it is under pressure. The seals can be damaged.

3. Release the screw fixing between the gas cylinder and the high pressure regulator.
4. Put the protective cap on the connections. Store the device in dry and clean conditions.

### Connection to the central gas supply (CGS)

💡 Please also refer to the CGS user manual.

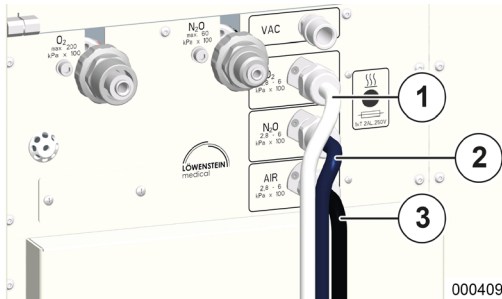

The connections (the standard is NIST) for the central gas supply are situated on the rear left of the device. The supply pressure on the device connection must be between 2.8 and 6,0 kPa × 100 (bar).

💡 Use ISO 32-compliant colour-coded pressure tubes:

- (1) O<sub>2</sub>: white
  - (2) N<sub>2</sub>O: blue
  - (3) AIR: black-and-white
- Vacuum: yellow (not illustrated)

#### Short CGS check

1. Check the CGS pressures.
2. Check the seals on the connections.

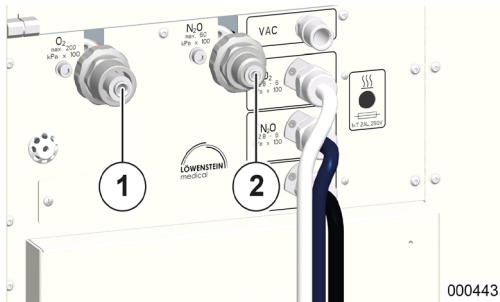
**Reserve gas bottle connection (2l or 3l)**

The connections (the standard is DIN) for the reserve gas bottles are situated on the rear of the device. The connections are shape-coded so they cannot be confused.

- (1) O<sub>2</sub>
- (2) N<sub>2</sub>O

The bottle pressure is displayed on the pressure manometers on the front.

 *Connecting and checking the reserve gas bottles (→ "Replacing the reserve gas bottles and 10 L bottles" p. 270).*

 *Reserve gas bottles should also be connected to the device for gas supply through the CGS.*

**Short check of reserve gas bottles**

1. Make sure that the bottles are filled. Pressure
  - O<sub>2</sub>, AIR > 120 kPa × 100 (bar)
  - N<sub>2</sub>O > 40 kPa × 100 (bar)
2. Check the seals on the connections.
3. Make sure that the bottle valves are closed.

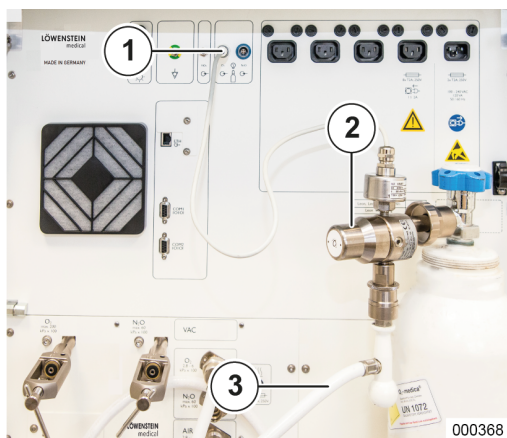
**10 L bottle connection instead of CGS**

Instead of the central gas supply, the *leon plus* can also be supplied with fresh gas from two 10 L bottles. The gases available are O<sub>2</sub> and optionally either AIR or N<sub>2</sub>O. If N<sub>2</sub>O is selected, AIR is replaced by O<sub>2</sub> as a drive gas. The supply pressures on the device connection must be between 2.8 and 6,0 kPa × 100 (bar).

1. Screw the high pressure regulator onto the particular bottle connection.
2. Place the bottle(s) on the right next to each other at the back inside the device in the holder provided.
3. Turn the bottle(s) until the high pressure regulators show towards the front slightly towards the left (it must be possible to close the rear wall doors).
4. Secure the bottle(s) with the lashing straps.
5. Connect the outlets of the high pressure regulator with the appropriate connections (the standard is NIST) via pressure tubes on the device.
6. Plug the high-pressure sensors into the ISO 32-compliant (coloured ring) coded sockets in the rear wall of the device.
  - O<sub>2</sub>: white ring
  - AIR: black ring
  - N<sub>2</sub>O: blue ring

The bottle pressures are displayed in the limit values window.

(→ "Pressure display when supply from 10 L bottles" p. 196)

- (1) pressure sensor connection
- (2) pressure regulator
- (3) pressure tube

- 💡 Use the 4 kPa × 100 (bar) pressure regulator prescribed by Löwenstein Medical.
- 💡 The type of gas contained in the 10 L bottles must be configured in the service. O<sub>2</sub> is always available, while AIR and N<sub>2</sub>O are optional.
- 💡 Connection and checking of 10 L reserve gas bottles (→ "Replacing the reserve gas bottles and 10 L bottles" p. 270).



**Short check of 10 L bottles:**

1. Make sure that the bottles are filled (O<sub>2</sub> pressure, AIR > 120 kPa × 100 (bar)  
N<sub>2</sub>O > 40 kPa × 100 (bar)).
2. Check the seals on the connections.
3. Make sure that the bottle valves are opened (does **not** apply to AIR and CGS 10 L bottle connection). (→ "AIR and CGS 10 L bottle connection" p. 76)
4. Check that the bottles are secure in the holder.
5. Make sure that the high pressure sensors are plugged into the sockets in the rear wall of the device.

**10 L bottle connection as reserve bottles**

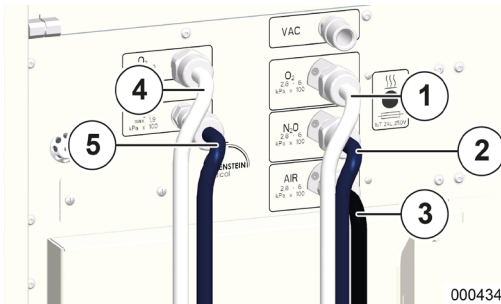

Two 10 L bottles can also be attached to the leon *plus* as reserve gas bottles.

The two device connections are situated vertically one on top of the other on the rear left of the device instead of the device attachments for the 2 L or 3 L reserve gas bottles.

The supply pressures on the device connection must be between 1.8 and 2.0 kPa × 100 (bar).

The procedure for attaching the bottles and the short check are carried out as described above (→ "10 L bottle connection instead of CGS" p. 74).

💡 *Use colour-coded pressure tubes in accordance with ISO 32:*

- (1) O<sub>2</sub> (CGS): white
- (2) N<sub>2</sub>O (CGS): blue
- (3) AIR (CGS): black-and-white
- Vacuum: yellow (not illustrated)
- (4) O<sub>2</sub> (10 L reserve)
- (5) N<sub>2</sub>O (10 L reserve)

**Short CGS check**

1. Check the CGS pressures.
2. Check the seals on the connections (→ "Short check of 10 L bottles" p. 75).

💡 *Use the 1.9 kPa × 100 (bar) pressure reducer prescribed by Löwenstein Medical.*

## AIR and CGS 10 L bottle connection

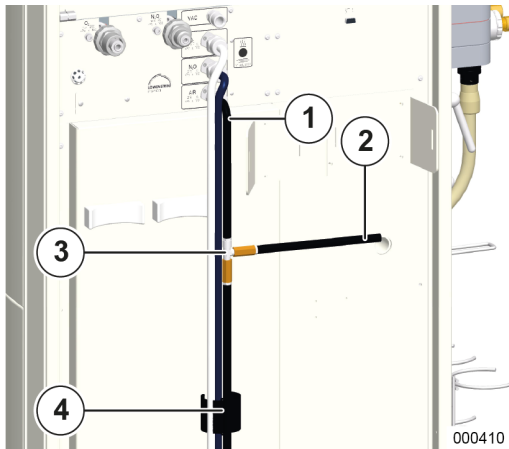

For AIR there is the option of parallel connection to a 10 L cylinder and the CGS. This requires a pressure tube with a T-connector.

(→ *leon plus*, *leon and leon mri List of accessories and replacement parts*)

1. Screw the pressure tube with the NIST fitting to the T-connector on the device's NIST connector.
2. Join one exit (long pressure tube) of the T-connector to the CGS and the other, shorter one to the high-pressure reducer on the 10 L cylinder.
3. Plug the high-pressure sensor into the ISO 32-compliant (black) coded sockets on the rear wall of the device.

💡 *The cylinder pressure is displayed in the Limit value frame (→ "Pressure display when supply from 10 L bottles" p. 196) .*

- (1) Tube with NIST fitting
- (2) to the cylinder
- (3) AIR pressure tube with T-connector
- (4) to the CGS

**Short CGS check**

1. Check the CGS pressures.
2. Check connections for leak-tightness (→ "Short check of 10 L bottles" p. 75).

**!**  
**ATTENTION**

Connection to the AGSS!

**Connection to the rear wall not possible**

- The connection must be made directly to the patient module
- The intake system must be hung on the side of the device.

💡 *It is recommended that the AIR 10 L bottle is closed if the *leon plus* is supplied via the CGS.*

*It is recommended that the pressure tubes are guided through the Velcro fastener in the lower third of the rear wall of the device.*

(→ "Tube holder" p. 34)

### Vacuum and external high-pressure gas outlet connection

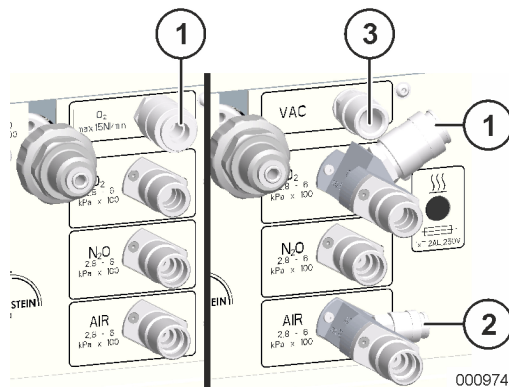

There is either a connection for vacuum (alternative to compressed air) to drive the internal bronchial aspiration or an O<sub>2</sub> high-pressure outlet to connect to an additional O<sub>2</sub> flow meter via the connections to the CGS.

An AGSS can be connected to the CGS connection for AIR via an AIR high-pressure outlet.

- (1) O<sub>2</sub> high-pressure outlet
- (2) AIR high-pressure outlet
- (3) Vacuum

 *The decrease at the O<sub>2</sub> high-pressure outlet may not exceed 15 NI/min, and on the AIR high-pressure outlet 75 NI/min.*

### Electrical connections

#### Connection to the mains

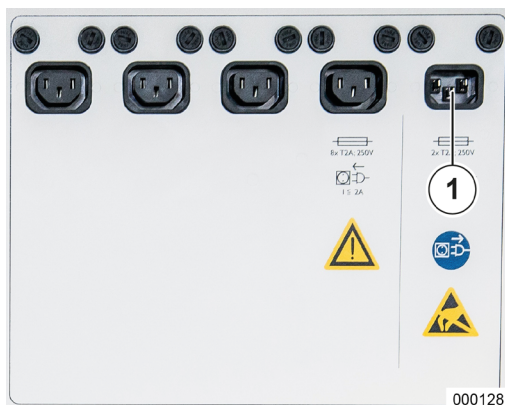

The connection for the voltage supply is situated on the top right on the rear of the device.

This is an IEC socket.

- (1) Voltage supply

 *When the IEC device is unplugged, the device is cut off from the mains completely.*

 *Do not use power supply cables longer than 5 metres.*

Possible voltage supplies at the following frequencies are:

- 100–240 V<sub>AC</sub>, 50/60 Hz

The green LED below the plug icon on the keypad shows that mains voltage is available.



The plug icon appears in green in the title bar on the right if mains voltage is available. The battery icon appears in white with the display of the charging state shown as a percentage.

### Connection of the equipotential bonding



To produce potential equalisation, join a connection provided for this purpose at the installation site via a suitable conductor (potential equalisation conductor HuL item number 0170501) to the potential equalisation provided on the device.

*The additional potential equalisation has the task of balancing potential differences between different simultaneously exposed metal components to protect the patient, user and third parties from contact voltages.*

- (1) Potential equalisation

### Mains connection fuses

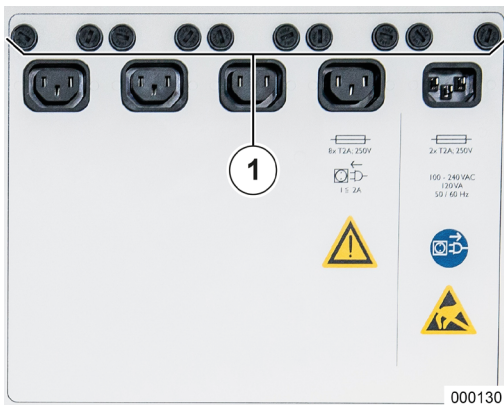

If the device reports “**Mains failure. Device running on battery**”, the fuses on the IEC socket of the *leon plus* may be faulty.

- (1) Fuses

### Connection of the workstation light

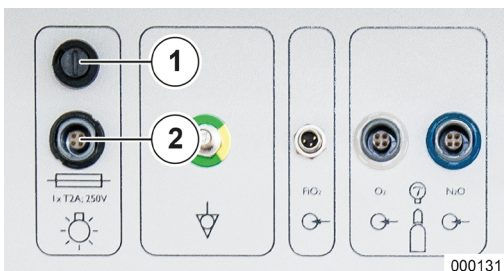

The voltage supply cable of the light is pulled through the left upper cable opening and plugged into the socket provided (coded by shape and black ring). The light fuse is situated above the socket.

- (1) Workstation light fuse
- (2) Workstation light socket

*These are inert 2AL fuses. The attachments for the fuses are released with a size 1.2 x 6.5 slot screwdriver.*

*The lamp is turned off during battery operation.*

### Connection of the respiratory bellows and the dome

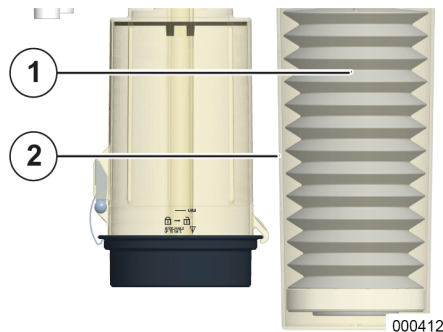

1. To fix the respiratory bellows and the dome, take off the patient module and place it upside down on a firm base.
2. Pull the respiratory bellows onto the joining supports.
3. Turn the dome into the carrier on the patient module (anticlockwise).

(→ "Connection for respiratory bellows, dome and CO<sub>2</sub> absorber, PEEP valve diaphragm cover, flow sensors" p. 66)

- (1) Respiratory bellows  
(2) Dome

### Removing and installing the CO<sub>2</sub> absorber

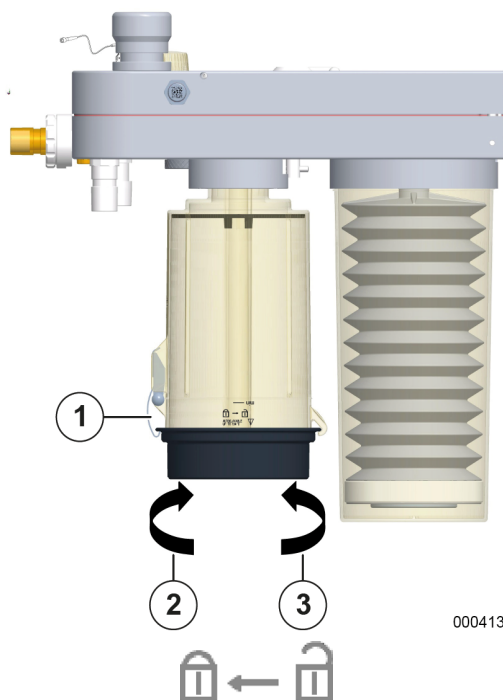

A filled CO<sub>2</sub> absorber can only be removed or installed if the patient module is situated on the docking station.

Unlock the CO<sub>2</sub> absorber by turning in a clockwise direction and take it out of the carrier.

- (1) clamp  
(2) close  
(3) open

**💡** The CO<sub>2</sub> absorber can also be changed when the device is in operation, as in the removed state the outlet and inlet of the CO<sub>2</sub> absorber are short-circuited. The alarm notification "CO<sub>2</sub> absorber removed. Circle system short-circuited" appears on the screen.

To reinstall the CO<sub>2</sub> absorber in the carrier, the clamp must be visible on the front of the absorber jar. The CO<sub>2</sub> absorber is locked by rotating it to the left.



#### WARNING

Changing the CO<sub>2</sub> absorber!

#### Risk of CO<sub>2</sub> rebreathing

- If the CO<sub>2</sub> absorber is changed during ventilation, it should be done rapidly, as CO<sub>2</sub> rebreathing could occur due to the short circuit when the CO<sub>2</sub> absorber is removed.

## Changing, emptying, filling the CO<sub>2</sub> absorber



**CAUTION**

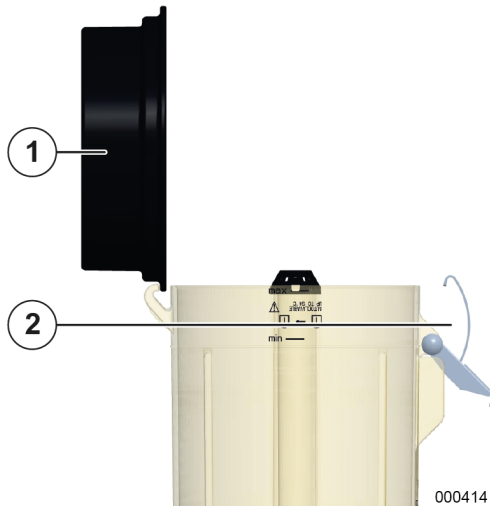

Discolouration of the soda lime!

### Risk of oxygen deficiency

- Discolouration of the soda lime or an increased inspired CO<sub>2</sub> measured value indicates inadequate CO<sub>2</sub> absorption capacity.
- The lime should be changed.

### Opening the CO<sub>2</sub> absorber

1. Turn the CO<sub>2</sub> absorber with the lid upwards.
2. Open the lid by pulling the clamp on the absorber jar outwards.
3. First lift up the lid in the guide into a vertical position, then take it out.
4. Empty the CO<sub>2</sub> absorber jar and have the CO<sub>2</sub> absorber hygienically prepared.

(1) lid

(2) clamp



**WARNING**

Eye contact with soda lime!

### Risk of serious eye injury

- Avoid soda lime contact with the eyes.
- Get medical help immediately.
- Rinse thoroughly with water (for at least 30 minutes).



**WARNING**

Skin contact with soda lime!

### Risk of skin irritation

- Avoid soda lime contact with the skin or clothing.
- Get medical help immediately.
- Rinse thoroughly with water for at least 15 minutes.
- Take off, remove and clean clothing and shoes to avoid further exposure.



**WARNING**

Inhalation or swallowing of soda lime!

### Risk of poisoning and irritation of the skin and respiratory tract

- Get medical help immediately.
- After swallowing, do not induce vomiting; drink plenty of water.
- After inhalation, get into fresh air immediately.



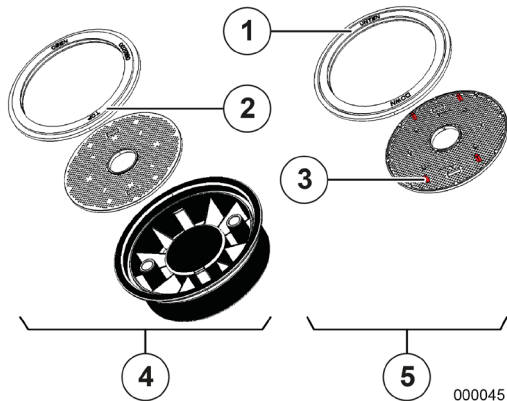

### Assembling the CO<sub>2</sub> absorber lid

1. Take the lid of an hygienically reprocessed CO<sub>2</sub> absorber.
2. Ensure that the sieve and seal in the lid are present and installed correctly. The top side must show upwards.

- (1) Seal with **UNTEN/DOWN** labelling
- (2) Seal with **OBEN/TOP** labelling
- (3) Underside of sieve with distance pieces
- (4) Top sides (correct)
- (5) Bottom sides (wrong)

💡 The top side of the seal is labelled **OBEN/TOP**, while the bottom side of the sieve can be recognised by the missing distant pieces. Ensure that the seal is fitted cleanly and correctly.

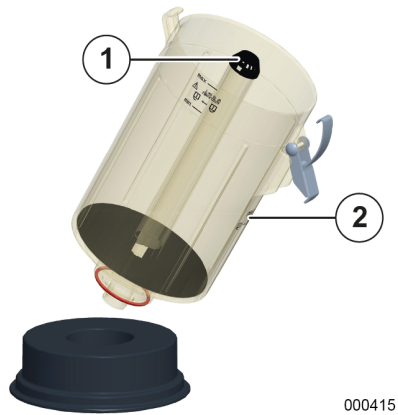

### Preparing the CO<sub>2</sub> absorber jar for filling

1. Place the lid with the inner side down on a firm, disinfected base.
2. Place the CO<sub>2</sub> absorber jar in the hollow provided in the lid.

💡 Ensure that the lid is exactly in line with the CO<sub>2</sub> absorber jar and is not offset to the side or twisted when suspended in the guide.

3. Make sure that the protective cap is on the gas feed.

- (1) protective cap
- (2) gas feed

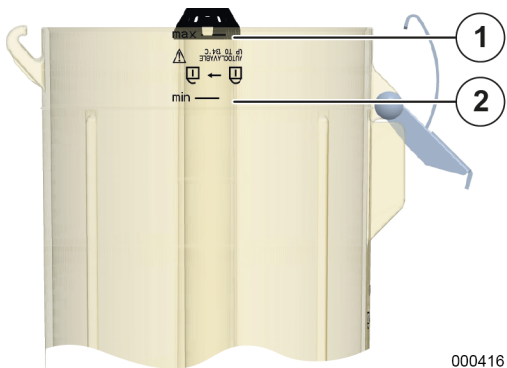

### Filling the CO<sub>2</sub> absorber jar

1. Fill the absorber jar up to at least the **min** filling mark and to the **max** filling mark at most.

- (1) max
- (2) min

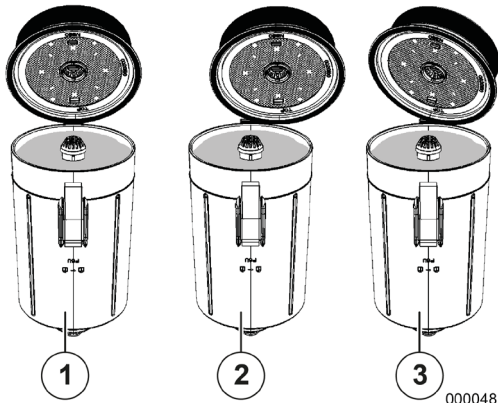

### Closing the CO<sub>2</sub> absorber jar

1. Take the CO<sub>2</sub> absorber jar out of the hollow provided in the lid.
2. Close the CO<sub>2</sub> absorber jar by hanging the lid vertically in the guide, turning it downwards and closing with the help of the clamp.

- (1) correct  
(2) wrong  
(3) wrong

 Ensure that the lid is exactly in line with the CO<sub>2</sub> absorber jar and is not offset to the side or twisted when suspended in the guide.

### Connection of the ventilation tubes

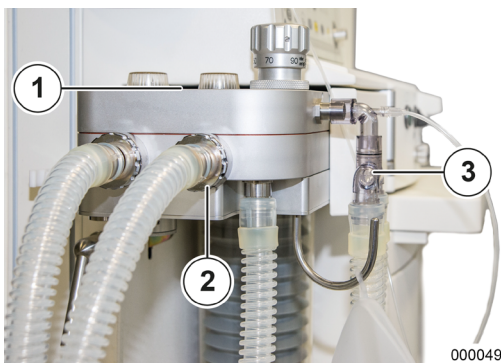

1. Put the ventilation tubes onto the two cones (Ø 22 mm) on the front of the patient module.
2. Connect the ventilation tubes on the other end (the patient's side) using a y-piece.

- (1) insp./exp. labelling  
(2) cones Ø 22 mm  
(3) y-piece

 Avoid using "tube-in-tube" systems. When using "tube-in-tube" systems, a leak in the internal lumen is not detected in the system test.



**WARNING**

Use of antistatic or conductive tubes and high-frequency electrosurgical devices!

#### Risk of burning

- Do not use any antistatic or conductive tubes.



**WARNING**

No unauthorised auxiliary parts!

#### Electrical risk to the patient

- Use authorised accessories only.



## Gas measurement

---

### FiO<sub>2</sub> measurement

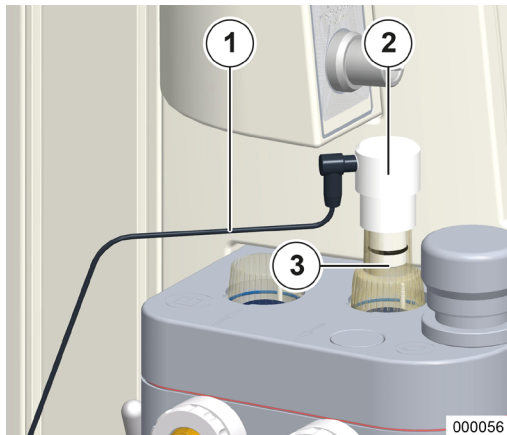

**1.** Use an adapter instead of the inspiratory sight glass to place the FiO<sub>2</sub> sensor on the patient module.

**2.** Connect the sensor via a cable on the rear wall.  
(→ "Rear wall" p. 63)

(1) Cable

(2) FiO<sub>2</sub> sensor

(3) Adapter

### Sidestream measurement

The connector for the sidestream measurement is situated on the option board or option panel.

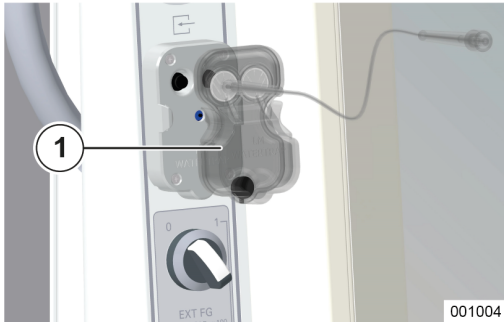

#### Connecting the watertrap (LM Watertrap)

1. Put the Variant LM Watertrap in the mounting provided on the option panel by pressing the mounting from the front until it noticeably locks into place.

(1) LM Watertrap

*The LM Watertrap is used in adults, children and neonates. The sample line is permanently connected to the watertrap.*

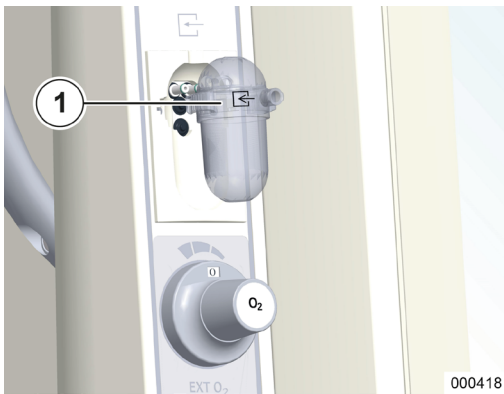

#### Connecting the watertrap (DRYLINE™ watertrap)

1. Place the variant DRYLINE™ watertrap in the mounting provided on the option panel by pressing the mounting from the front until it noticeably locks into place.

(1) DRYLINE™ watertrap

*Regularly check the fill state. When emptying or replacing the watertrap, please note (→ "Gas measurement maintenance (sidestream measurement)" p. 263).*

*The watertrap should be changed once per month.*

*The device may only be operated with one of the two watertrap variants.*

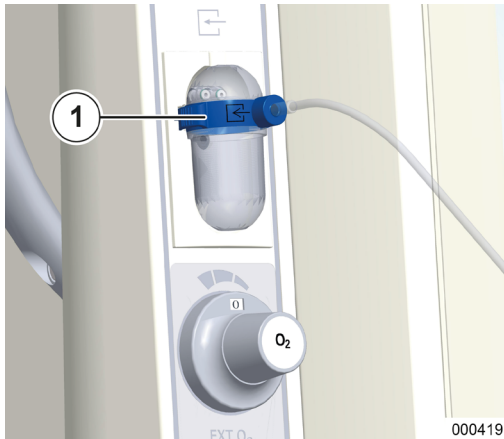

**Connecting the sample line (only for variant DRYLINE™ watertrap)**

2. Connect the sample line to the connection provided (luer lock) on the watertrap.

(1) watertrap and sample line with blue coding

💡 *When ventilating neonates, please use the watertrap and the sample line for neonates (blue coding). For children and adults, use the watertrap and sample line for adults (without blue coding). If there is a requirement to use only one type of watertrap (e.g. for logistical reasons), the type with blue coding is to be used.*

💡 *Use authorised accessories only.*

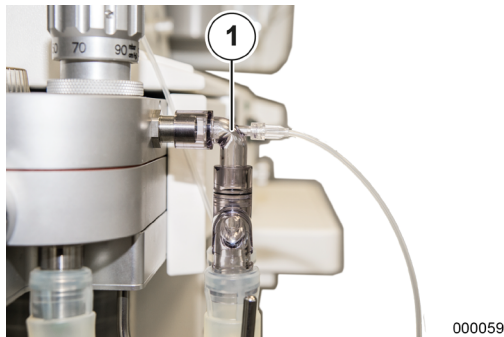

**Connecting the patient adapter**

3. Connect the sample line to the connection provided (luer lock) on the patient adapter.

4. Place the patient adapter on the patient's side onto the Y-piece.

(1) Patient adapter (angled)

💡 *Insert suitable VSF (on the patient's side on the patient adapter).*

💡 *Use patient adapters and Y-piece as listed in leon plus, leon and leon mri List of accessories and replacement parts, as otherwise measured CO<sub>2</sub> values may be falsified.*

### Connection of the ventilation bag

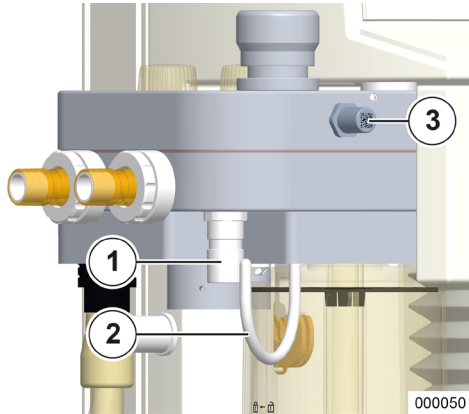

**1.** Connect a ventilation tube to the cone (Ø 22 mm) on the underside of the patient module.

- (1) cone Ø 22 mm
- (2) suspension bracket for the ventilation bag
- (3) test adapter

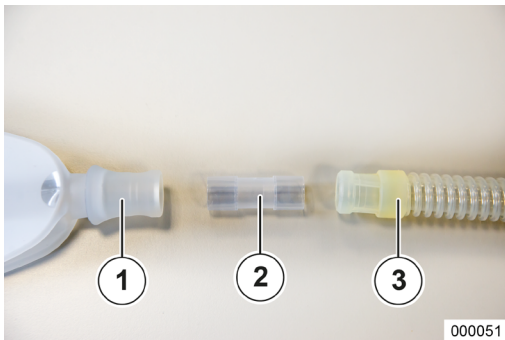

**2.** Join the ventilation bag via an adapter to the ventilation tube.

**3.** Hang the ventilation bag to the suspension bracket provided.

- (1) ventilation bag
- (2) disposable tube connector
- (3) tube

## Connection to the anaesthesia gas scavenging system

### Connection of the AGSS directly to the patient module

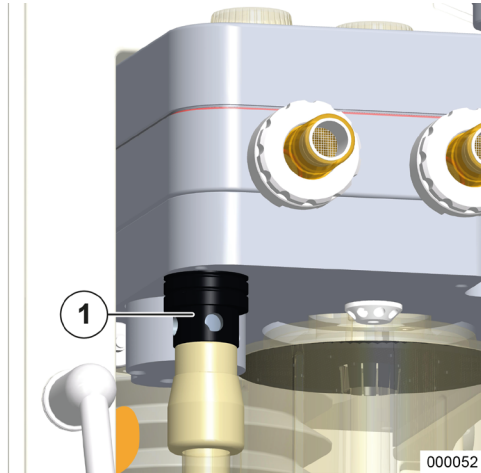

1. Join the waste hose to the cone ( $\varnothing$  30 mm) on the underside of the patient module via the adapter.
2. Join the other end of the waste hose to the waste disposal system via an appropriate coupling.

(1) AGSS adapter

💡 *The AGSS must comply with ISO 80601-2-13.*

💡 *Please also refer to the waste disposal system user manual.*

**!**  
**ATTENTION**

If an intake system is not used, it is imperative that this adapter (with four drill-holes as additional air intake) is used.

The aspiration performance of the waste removal system must be between 55 and 66 l/min.

### Connecting the AGSS via the rear of the device

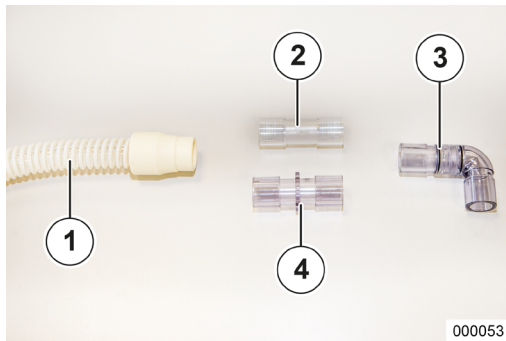

1. Assemble the tube connector following the adjacent illustration.
2. Join the AGSS tube to the cone (Ø 30 mm) on the underside of the patient module via the AGSS adapter.

(→ "Connection of the AGSS on the rear of the device" p. 65)

3. Place the adapter at an angle on the AGSS connector at the front of the housing.

(→ "Connection of the AGSS on the rear of the device" p. 65)

4. Join the waste hose to the AGSS connector on the rear of the device via the disposable tube connector.

(→ "Connection of the AGSS on the rear of the device" p. 65)

5. Join the other end of the waste hose to the waste disposal system via an appropriate coupling.

(1) AGSS tube

(2) disposable tube connector

(3) angled adapter

(4) ISO 22/22 plug adapter

(→ *leon plus*, *leon and leon mri List of accessories and replacement parts*)

## Suspension bracket of the intake system on the rear of the device

---

The intake system is suspended on a standard rail on the rear of the *leon plus*. To connect, use the construction described in (→ "Connection of the AGSS on the rear of the device" p. 65).

---



### ATTENTION

The AGFS adapter described in (→ "Connection of the AGSS directly to the patient module" p. 87) must not have any holes drilled (additional air inlet is ensured via the mounting system).

---

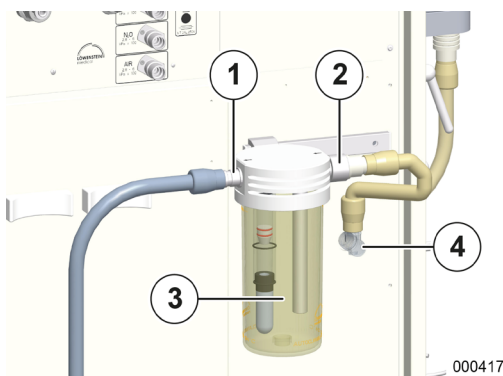

1. Join the inlet of the intake system to the AGSS connection on the rear of the *leon plus* with the help of a disposable tube connector and an AGSS tube.
2. Join the outlet of the intake system to the waste disposal system via a waste hose and an appropriate coupling.

- (1) outlet  
(2) inlet  
(3) intake system  
(4) AGSS connection

 Please also refer to the intake system user manual.



### ATTENTION

If using an intake system, it is imperative to use the "white" adapter (without drill-holes).

---

## APL valve

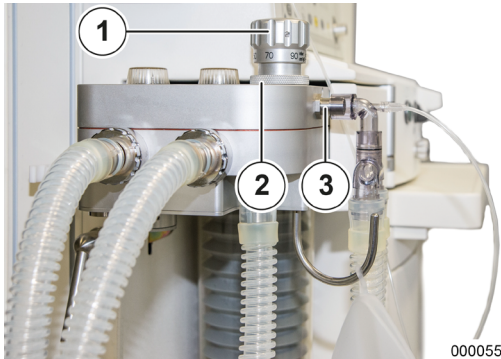

1. Lock the APL valve with a bayonet catch on to the patient module

- (1) APL
- (2) APL bayonet catch
- (3) test adapter

## Setting up the anaesthetic vaporiser

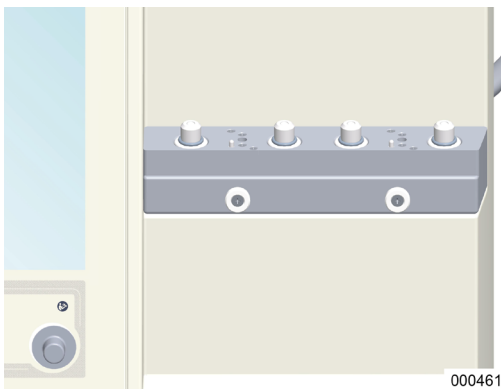

The *leon plus* provides a mounting for two anaesthetic vaporisers.

The anaesthetic vaporisers have a transportation safety catch, which must be removed before start-up (the arrow on the adjusting ring must lie over the arrow on the housing).

The anaesthetic vaporisers are interlocked so that just one of them can be operated if desired.

💡 *Desflurane anaesthetic vaporisers can be supplied with power via the auxiliary outlets (→ "Rear wall" p. 63). Before the auxiliary sockets can be used, the socket cover above them must be removed. (only in 3rd edition devices)*

*In the event of plugs not fitting, please contact a Löwenstein Medical representative.*

💡 *Adapt, fill and operate the anaesthetic vaporisers in accordance with their user manual.*



### ATTENTION

The auxiliary outlets are switched off during battery operation!

#### No power supply to the desflurane anaesthetic vaporiser

- supply via an external socket
- connect the anaesthesia device to mains power



## Connection of the bronchial aspiration

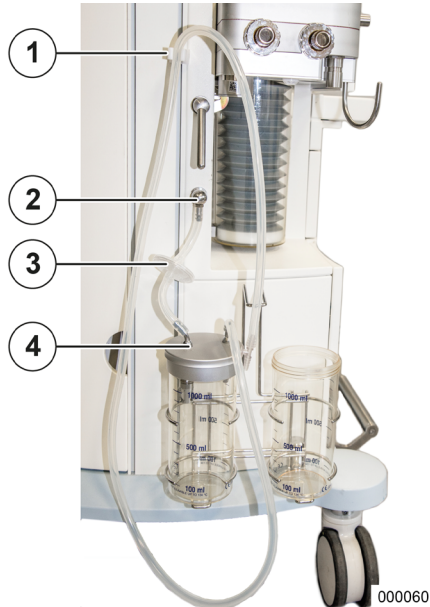

The connection of the bronchial aspiration is suitable for vacuum-driven modes only and is designed for  $\varnothing_{\text{inside}}$  6 mm tubes.

1. Use a filter (follow the flow direction) to join the connection on the device to the connection on the lid of the absorber glass, which has a one-way valve on the inside.
2. Join the other connection on the lid of the absorber glass to the suctioning tube and the spout to the connection of the aspiration catheter.
3. Hang the tube in the provided bracket.

(1) aspiration tube holder

(2) bronchial aspiration connection

(3) filter

(4) lid connection

💡 *For connection and checking, refer to the bronchial aspiration manual.*

💡 *Observe correct connections on the lid of the absorber glass.*

## Connection of auxiliary devices

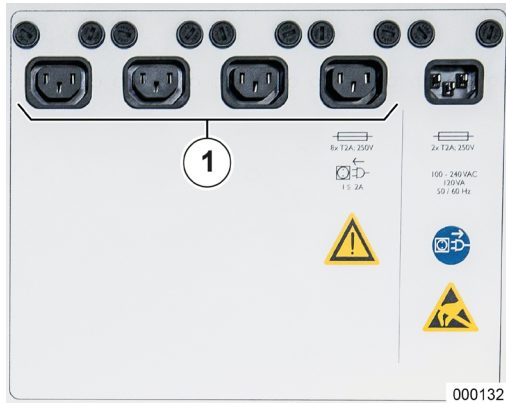

A maximum of four auxiliary devices can be connected to the socket board at the back. The socket cover must be removed before connecting an auxiliary device (only in 3rd edition devices). This is attached with 4 screws (Phillips). Reattach the cover after connecting the auxiliary devices.

### (1) auxiliary outlets

- 💡 *The connection of electrical devices to the multiplug socket leads to the formation of an ME system.*
- 💡 *The auxiliary outlets are switched off during battery operation.*
- 💡 *If an auxiliary device reports no mains voltage, also check the correct position of the plug and then the fuses on the low-heat device socket on the leon plus.*
- 💡 *Please note that the switch-on surge can be higher than the current consumption shown on the auxiliary device.*
- 💡 *The workplace may not contain more than these four auxiliary outlets.*
- 💡 *In the event of a faulty earth wire, the values of the patient leakage currents can increase to values which exceed the permissible values when connecting devices. Measuring is recommended.*



### WARNING

Higher total earth leakage current!

#### Risk of electric shock for the user

The total earth leakage current may not exceed 5 mA for connected auxiliary devices.

- Measure the total earth leakage current of the combination.



### ATTENTION

Overloading of auxiliary outlets!

#### Fuses blow

The total power consumption of the device including the 4 auxiliary outlets may not exceed 9 A.

- Follow the instructions of the accessory when installing.

## Connection of data communication

### General information

More detailed information on the connections is contained in the instruction manual “GA\_Ba-Interfaces” or from a Löwenstein Medical representative.

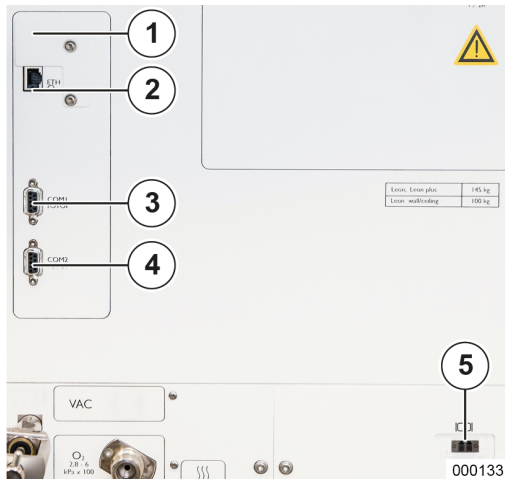

The Leon *plus* provides the following interfaces:

- (1) USB (for service purposes only)
- (2) Ethernet: RJ-45
- (3) Serial (COM 1): D-sub, 9-pin
- (4) Serial (COM 2): D-sub, 9-pin
- (5) LWL: LC socket

Only data output is provided via the LWL interface.

The two serial ports are separated galvanically. (3 kV).

The USB connection is covered (3rd Edition devices only) and is for service purposes only.



### CAUTION

Mobile phones, Smartphones, tablets, Smartwatches or other devices may not be connected to/charged using the USB connection.

The USB connection is intended only for updates and reading log files.

## 7. Start-up

Ensure that you have correctly checked the leon *plus* as described in the "Short checklist before start-up" (→ "leon plus Short checklist before start-up" p. 319).



*The execution of a system test is strongly recommended.*

*It is also strongly recommended that a "circuit system" system test block is executed after changing the patient tube system.*

*It is strongly recommended to perform the "flow measurement" system test block even after changing the patient tubing system and during ventilation with a small trigger threshold and small volumes.*

*The device is not operable during the system test. However, the test can be interrupted (not recommended).*

*If the system test is skipped, low or minimal flow may not be operated.*

*If the system test is not carried out, it must be executed at the next opportunity.*

**Short check (recommended by DGAI)**

Irrespective of the short check list on the device, the DGAI recommends a short check before a patient is connected to an anaesthesia device. The device's short check is an additional safety measure during operation or in emergency situations; this is absolutely necessary, but does not replace the thorough function check of the devices including accessories during the morning's start-up.

**Basically, this always applies when there are problems with ventilation:**

- quickly reach for the breathing bag which, as a fallback option, must be placed at every anaesthesia workplace and, if necessary, remove the artificial airway.

This short check encompasses three parts:

1. Check the ventilation system for
  - gas flow function ("PaF test" pressure and flow)
  - correct installation
  - larger leakages or obstructions

Select the ventilation mode "Man/Spont." on the anaesthesia device and set the APL to 30 mbar. Close the patient connection (Y-connector). Fill the ventilation system and manual breathing bag with the O<sub>2</sub> flush. With manual compression, the manual breathing bag must not empty ("pressure"). When the patient connection is reopened, a clearly noticeable gas flow must escape ("flow").

In addition, at least a few manual/assisted breaths are always given before starting mechanical ventilation.

2. The FiO<sub>2</sub> or O<sub>2</sub> measurement serves to verify that the colourless and odourless gas mixture supplied to the patient contains enough oxygen.
3. Capnometry serves to verify that the lungs are ventilated.

In the event of any abnormalities, the connection between the patient and the anaesthesia device is disconnected again and systematic troubleshooting is initiated. Meanwhile, ventilated patients are ventilated with the obligatory separate manual breathing bag.

## Configuration (in standby)

### Config tab

#### General information



To call up the **Config** tab, proceed as follows:

1. Activate the tab in the **Extras** tab in the 1st row.
2. Activate the corresponding tab of the tab in the 2nd row.

The following settings are available:

- settings
  - brightness (TFT)
  - illumination (is only shown if configured in the service)
- service

(1) **Config** tab

(2) **Extras** tab

### Illumination of the writing shelf

On the **Config** tab you can switch the light ON and OFF (only if configured in the service).

- Lighting: ON/OFF



1. Select the **Lighting** button.

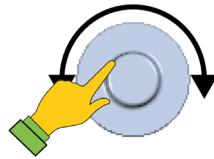

2. Unlock the function.
3. Select a value for the lighting.
4. Confirm the value.

### Brightness of the screen (TFT)

The brightness of the TFT can be set on the **Config** tab.

- brightness: 0 – 100
- increment: 5



1. Select the **Display Brightness** button.

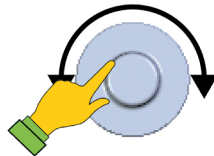

2. Unlock the function.
3. Select a value for the brightness of the screen (TFT).
4. Confirm the value.

## Volume tab



The volume can be changed on the **Volume** tab.

- volume: 50-100
- increment: 5

- (1) **Extras** tab
- (2) **Volume** tab

💡 *Only the volume of medium-priority alarms can be changed. The fact that the volume of high-priority alarms may not be changed by the user is a normative requirement, in accordance with DIN EN ISO 60601-1-8 (→ "Adjusting the max. alarm volume" p. 114).*

1. In **Settings**, select the **Volume** tab.
2. Select the numeric keypad on the right adjacent to the **medium-priority alarms**.

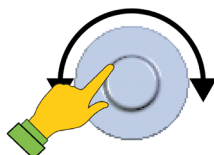
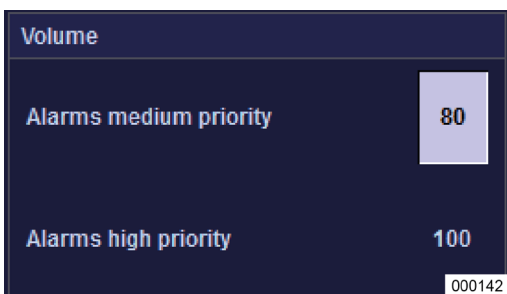

3. Unlock the function.
4. Select a value for the volume.
5. Confirm the value.

💡 *If a red alarm is active, the alarm value cannot be changed (numeric keypad "medium-priority alarms" is inactive).*



## System Time tab

### General information



To call up the **System Time** tab, proceed as follows:

1. Activate the tab in the **Extras** tab in the 1st row.
2. Activate the corresponding tab of the tab in the 2nd row.

The following settings are available:

- settings
  - date
  - time

- (1) **System Time** tab
- (2) **Extras** tab

### Date, time

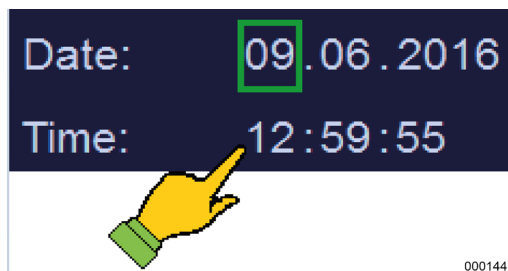

1. Select the entry to be changed in the **Date** or **Time** fields (day, month, year, or hour, minute, second).

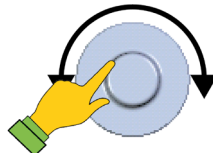

2. Unlock (day, month, year, or hour, minute, second), set and confirm.

### Option tab



To call up the **Option** tab, proceed as follows:

1. Activate the tab in the **Extras** tab in the 1st row.
2. Activate the corresponding tab of the tab in the 2nd row.

The following information and settings are available:

- Information
  - System test result

- (1) **Extras** tab
- (2) **Option** tab

### Configuration (during ventilation)

### Config tab



The following settings are available:

- settings
  - brightness (TFT)
  - Lighting (is only shown if configured in the service)

- (1) **Config** tab
- (2) **Extras** tab

## Volume tab

---

(→ "Volume tab" p. 98)

## Option tab

---

(→ "Option tab" p. 100)

## System configuration of the user interface

---

### General information

The following changes to the configuration can also be carried out while the device is in operation. However, they continue to apply only until the device is turned off.

The following setting can be reset by the **Reset To Default Settings** button, if desired.

- Alarms, ventilation parameters and fresh gas blenders
- Curves, trend curves, tabular trend
- All settings (1st and 2nd)



*Only the settings of the currently selected patient category are reset.*

(→ "Load default settings" p. 143)

**Real-time and trend curves**



**Configuration of real time**

Real-time and trend curves can be configured as follows:

- Selection of which measured value is displayed
- Shifting of 0 point in the window
- Scaling of the Y-axis
- ON/OFF autoscaling
- Number (minimum 1, maximum 4) of the displayed real-time curves
- Scaling of the X-axis (4–30 seconds)

(→ "Table 12: Icons/screen (control elements)" p. 44)

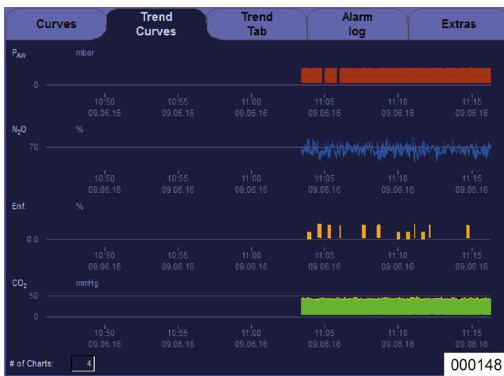

**Configuration of trend curves**

- Selection of which measured value is displayed
- Shifting of 0 point in the window
- Scaling of the Y-axis
- ON/OFF autoscaling
- Number (minimum 1, maximum 4) of the displayed trend curves
- Scaling of the X-axis (10 min - 72 hours)

**Configuration fresh gas blender**

**Option with N<sub>2</sub>O**

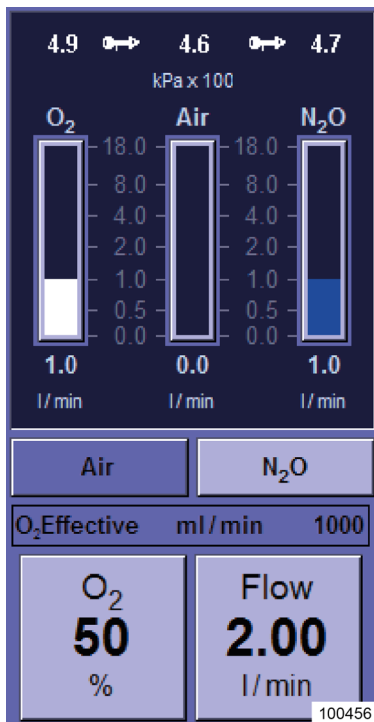

**Option without N<sub>2</sub>O**

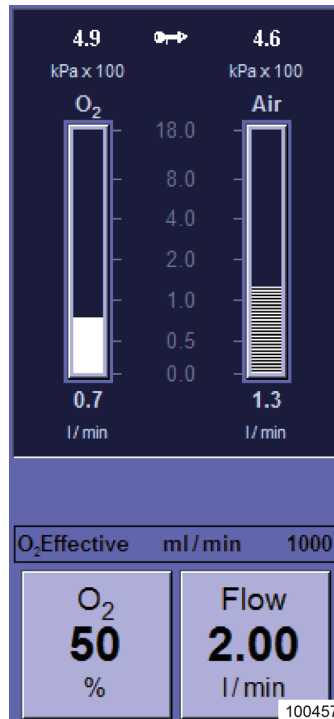

**Option without AIR and N<sub>2</sub>O**

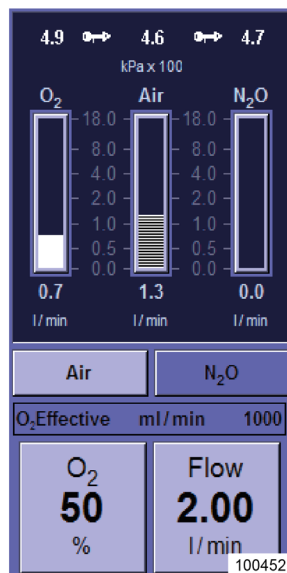
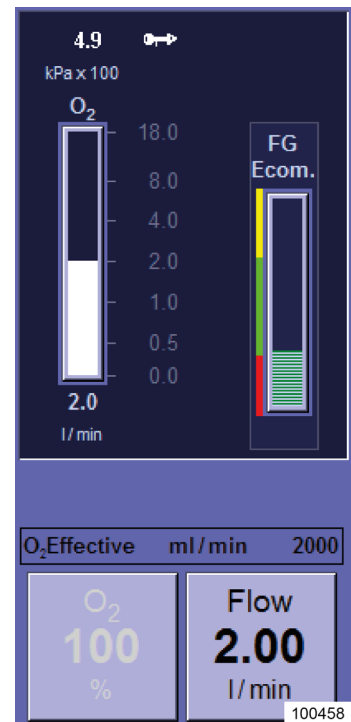

The gas quantities of the fresh gas are displayed as bar graphs. The following start values of the fresh gas blender can be configured:

- Carrier gas (N<sub>2</sub>O or AIR )
- O<sub>2</sub> concentration
- Fresh gas flow

(→ "Fresh gas setting" p. 145)

### Limit values configuration

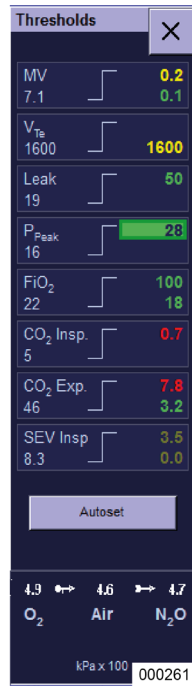

You can configure the upper and lower alarm limits manually.

(→ "Setting patient alarm limits manually" p. 207)

**Monitoring ventilation measured value configuration, calculated value I**

8 values are displayed on each of two pages, if desired (configurable). 4 values in the upper section of the monitoring window are displayed larger. This is where the important measured values should be positioned. These 4 measured values are the same on both pages.

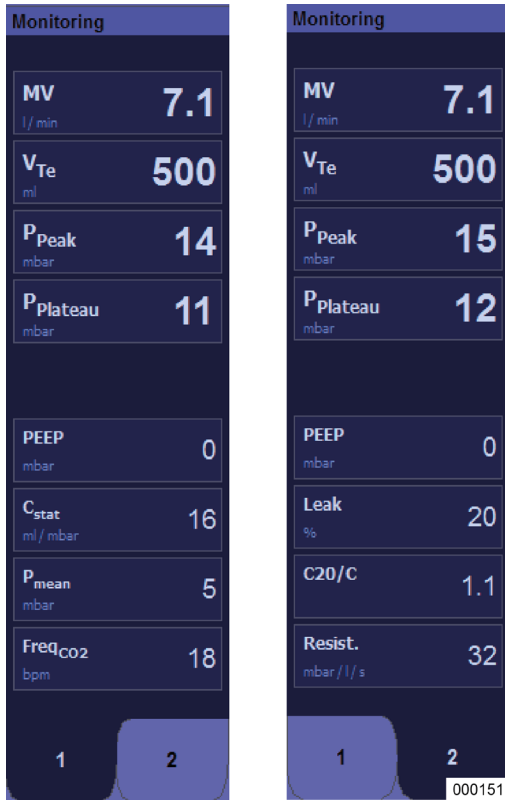

(→ "Monitoring ventilation measured values and calculated values I" p. 184)

**Configuration of form of ventilation**

The following ventilation parameters can be configured as starting values per form of ventilation:

(→ "Buttons for setting ventilation parameters" p. 158)

## Service



To call up the Service screen:

1. Change to the **Extras** tab.



2. Then change to the **Config** tab.

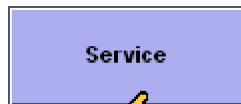

3. Activate the **Service** button on the touchscreen.

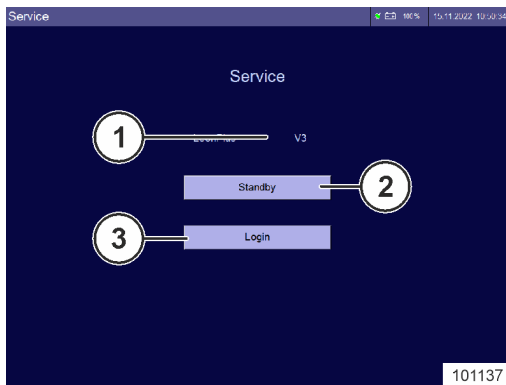
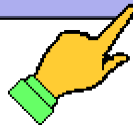

4. The **Standby** button takes you back to the standby screen.

*This screen can only be called up from standby.*

Information:

(1) First digit of the software version (for full versions, see (→ "Service information" p. 109))

Selection buttons:

(2) Standby

(3) Login

### Information

### Software version

The first digit of the current software version is displayed in the line **Version:** (for full versions, see (→ "Service information" p. 109)). This information is useful when seeking telephone support from a Löwenstein Medical representative.



## Login

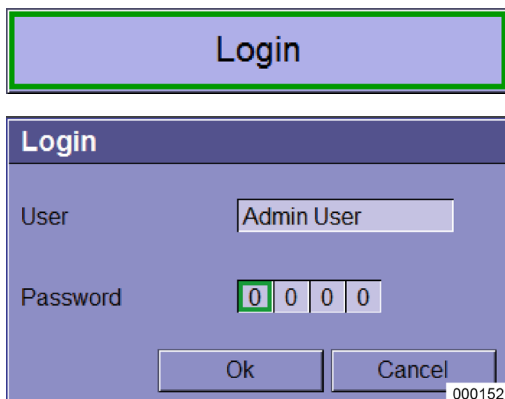

Certain functions in the service are only available to service technicians or trained staff authorised by Löwenstein Medical. Access is only possible via a login with password.

There are two password-protected user names, which differentiate between the scope of your system rights:

- Administrator
- Service technician



### WARNING

Changing settings!

#### Death or permanent injury of the patient

Depending on the scope of your rights, changes to settings and calibration data can mean that the life-sustaining device functions are no longer guaranteed.

- Contact a Löwenstein Medical service technician for information.



1. Select the **Login** button.

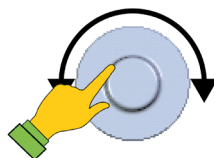

2. Unlock.  
3. Select a field.  
4. With the help of the rotary button, enter one figure of your 4-character password per field (a clockwise turn increases the figure, an anticlockwise turn lowers the figure).

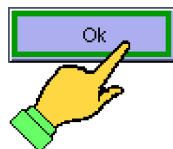

5. Confirm.  
6. Confirm the whole password.



*Do not leave the device in a logged-in state, as unauthorised persons could change settings and calibration data.*

*Restart the device if you were logged in.*



As long as you are logged into the service, a red line under the title bar with the message **Service Mode** makes you aware of this.

## Service tab

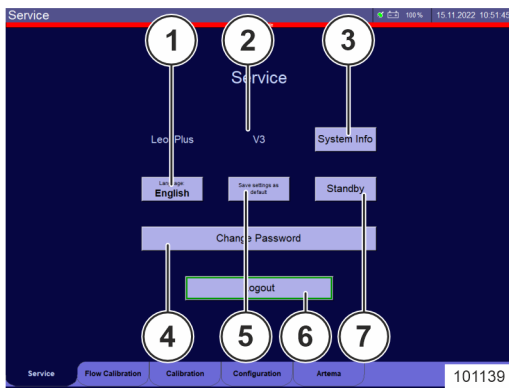

The following configuration can be carried out when you are logged in:

Settings

(1) Language

Information

(2) First digit of the software version (for complete versions, see (→ "Service information" p. 109))

(3) System information

Selection buttons

(4) Change password

(5) Save settings as default

(6) Logout

(7) Standby



*You will find a more detailed explanation of individual points in the service manual of the leon plus.*

### Service information

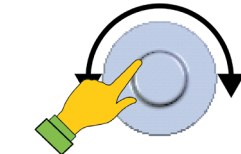
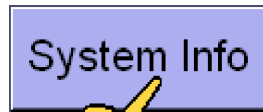

#### System Information

1. Select the **System Information** button.
2. Confirm the entry.

System Information			
System Version:	3.9.4		
Firmware Version:	3.9.4		
Conductor PIC Version:	5.4.5		
Monitor PIC Version:	6.4.1		
Power PIC Version:	0.3.6		
Kernel Version:	1.42.0	Kernel Date:	16.7.2007
NetDCU Version:	5.2.0	Bootloader Version:	1.18.0
Adapter Board Rev.:	V3 (0.3)	Controller Board Rev.:	V3 (0.3)
Version Check State:	OK		

The full versions of the software components are in the left-hand column. The versions of the hardware components are in the right-hand column. If the system discovers an unknown component or incompatibilities between hardware and software versions, this is displayed.

*This information is useful when seeking telephone support from a Löwenstein Medical representative.*

### Service settings

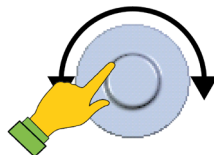

#### Language

1. Select the **Select Language** button.
2. Unlock.
3. Select a language.
4. Confirm.

### Saving the current system configuration

In the service menu, the current changed system configuration can be saved as the default via the **Save Settings As Default** button. The basic settings are designated as default (standard) settings, which the device shows when it is switched on.

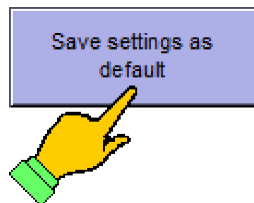

1. Select the **Save Settings As Default** button.

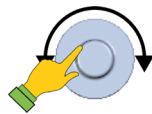

2. Confirm.

 Access to this Service feature is only possible via a login with password.

 You should refer to a service technician authorised by Löwenstein Medical for these settings.

### Change password

1. Select the User field.

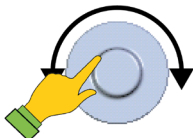

2. Select the User.



3. Confirm.

4. Select the New Password field.



5. Select a password.



6. Confirm.

7. Confirm with OK.

## Configuration tab/page 1

### Measuring unit of the measured CO<sub>2</sub> value

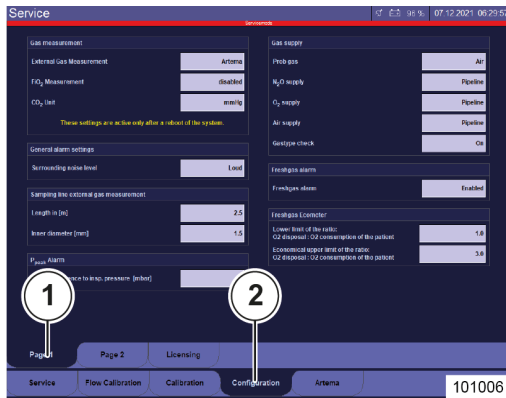

In the service menu, the unit of the measured end-expiratory CO<sub>2</sub> value can be selected under **Configuration/Page 1**.

The following are available:

- %
- mmHg
- hPa
- kPa

Access to this Service feature is only possible via a login with password.

(1) Tab **page 1**

(2) **Configuration** tab

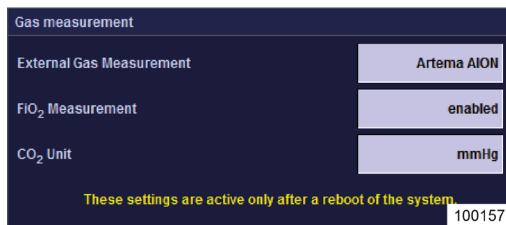

 *These changes are only visible when the device is turned OFF and then ON again. You should consult a Löwenstein Medical-authorized service technician for these settings.*

### Gas supply

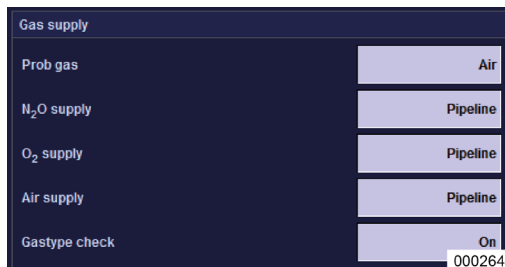

In the service menu, the gas supply for the device can be set under **Configuration/Page 1**.

(1) Tab **Page 1**

(2) **Configuration** tab

The following parameters are available for selection:

Drive gas

- air
- O<sub>2</sub>

N<sub>2</sub>O

- CGS
- bottle (10 L)
- not available

O<sub>2</sub>

- CGS
- bottle (10 L)

AIR

- CGS
- bottle (10 L)
- not available

Gas type check (in the system test)

- ON
- OFF



*The AIR selection not available is available only if O<sub>2</sub> was selected as the drive gas.*

### Limits for the econometer

Freshgas Ecometer	
Ecometer available	On
Lower limit of the ratio: O <sub>2</sub> disposal : O <sub>2</sub> consumption of the patient	1.0
Economical upper limit of the ratio: O <sub>2</sub> disposal : O <sub>2</sub> consumption of the patient	3.0

000155

In the service menu the limits x<sub>1</sub> and x<sub>2</sub> for the econometer can be set under **Configuration/Page 1**.

x <sub>1</sub>	Minimum lower level of the ratio: O <sub>2</sub> consumption Pat. + O <sub>2</sub> leak closed O <sub>2</sub> fresh gas flow.
1..2.9	
x <sub>2</sub>	Economic upper limit of the ratio: O <sub>2</sub> consumption Pat. + O <sub>2</sub> leak closed O <sub>2</sub> fresh gas flow
1.1 .. 3	

Access to this feature of the service is only possible via a login with password.



*You should refer to a service technician authorised by Löwenstein Medical for these settings.*

Table 17: Example for the setting of the limit between pressure gas shortage and economic consumption factor  $x_1$ 

$x_1$	Ratio O <sub>2</sub> consumption + O <sub>2</sub> leak to O <sub>2</sub> fresh gas flow	Ecometer turns red if	Ecometer turns green if
1	1:1	the set O <sub>2</sub> fresh gas flow is lower than the O <sub>2</sub> consumption + O <sub>2</sub> leak. (Patient undersupplied)	the set O <sub>2</sub> fresh gas flow is equal to or higher than the O <sub>2</sub> consumption + O <sub>2</sub> leak. (Maximum is limit to yellow)
2	2:1	the set O <sub>2</sub> fresh gas flow is lower than double the O <sub>2</sub> consumption	the set O <sub>2</sub> fresh gas flow is equal to or higher than double the O <sub>2</sub> consumption (maximum is limit to yellow)

Table 18: Example for the setting of the limit between economic consumption and uneconomic consumption factor  $x_2$ 

$x_2$	Ratio O <sub>2</sub> consumption + O <sub>2</sub> leak to O <sub>2</sub> fresh gas flow	Ecometer turns green if	Ecometer turns yellow if
1.1	1.1:1	the set O <sub>2</sub> fresh gas flow is lower than 1.1 times O <sub>2</sub> consumption + O <sub>2</sub> leak (minimum is limit to red).	the set O <sub>2</sub> fresh gas flow is equal to or higher than the 1.1 times O <sub>2</sub> consumption + O <sub>2</sub> leak.
2	2:1	the set O <sub>2</sub> fresh gas flow is lower than double the O <sub>2</sub> consumption + O <sub>2</sub> leak (minimum is limit to red).	the set O <sub>2</sub> fresh gas flow is equal to or higher than double the O <sub>2</sub> consumption + O <sub>2</sub> leak.

### Adjusting the max. alarm volume



In the service menu, the general max. alarm volume for the device can be set under Configuration/Page 1.

- (1) Tab **Page 1**
- (2) **Configuration** tab

### Display of title bar:



The following settings are available for selection:

- Loud (at least approx. 50dBA, max. approx. 70 dBA)
- Medium (at least approx. 50 dBA, max. approx. 64 dBA)
- Quiet (at least approx. 50 dBA, max. approx. 58 dBA)



*from software version 3.11.12.*



*Decibel is a logarithmic measure to indicate the ratio of two physical quantities of the same kind to each other.*

*A doubling of the perceived volume is therefore assigned 10 dB, a quadrupling then corresponds to 20 dB and an eightfold increase to 30 dB.*



## Configuration tab/page 2

### Configuration tab/page 2

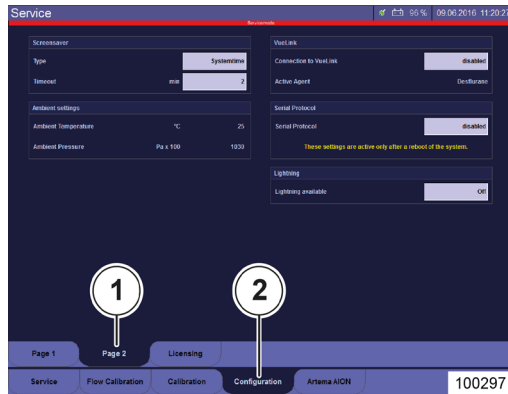

In the service menu, the lighting of the writing shelf can be configured to available or not available under **configuration/page 2**. A corresponding **Lighting** button appears in standby on the **Config** tab.

Access to this Service feature is only possible via a login with password.

 You should refer to a service technician authorised by Löwenstein Medical for these settings.

### Lighting



## Procedure for saving the system configuration

---

1. Turn on the leon *plus* as follows:
2. Switch to Service.
3. Log in.

### General settings

1. Set the language.
2. Set the brightness, volume, date and time.
3. Change to Configuration (tab).
4. Set the measurement unit of the measured CO<sub>2</sub> value.
5. Switch to standby (do not log out).
6. Start MAN/SPONT.
7. Configure the real-time charts.

### Setting dependent on the patient category

1. Switch to standby.
2. Select a patient category (adult, child or weight).
3. Start MAN/SPONT.
4. Configure monitoring and alarms.
5. Switch to standby.



---

Different default alarm settings!

#### **Danger of harm to patients**

Any alarms that occur are only displayed visually.

- Check the default alarm settings.

(→ "Load default settings" p. 143)

---

### Settings dependent on patient category and form of ventilation

Carry out the following for each form of ventilation in this patient category:

1. Start the form of ventilation.
2. Configure the presets of the ventilation parameters (only for **adult** and **child**; presets are calculated if **weight** is entered).



*Always switch back to MAN/SPONT before you configure the presets of the next form of ventilation.*

After configuring the presets of all of the forms of ventilation in this patient category:

3. Select the form of ventilation that should be active at system start-up when this patient category is selected.

### Store configuration

1. Switch to Service.
2. Save the current settings as default (button).
3. Change to Standby and restart with Item ... (→ "Setting dependent on the patient category" p. 116) to configure the other patient category.

### Active configuration after system start-up

1. Switch to standby.
2. Select the patient category that should be active at system start-up.
3. Select the form of ventilation that should be active at system start-up.
4. Save the current settings as default (button).
5. Restart the system.

## Device check

- 💡 *Run the selftest and the system test in **all** of the following situations:*
  - *Once a day*
  - *Before the first start-up*
  - *After every servicing and/or repair*
  - *After the device has been moved to a different location*
  - *After work on the central gas supply*
- 💡 *Make sure that you have carried out all work properly in accordance with (→ "Preparations" p. 68).*



**WARNING**

---

Device malfunction!

**Death or permanent injury of the patient**

- A device check must be run once a day.
- 



**WARNING**

---

Proper state of the device is not monitored, system test and self test not executed/skipped!

**Death or permanent injury of the patient**

- Run the self test and the system test:
- 



**WARNING**

---

Alarms at system start-up: Device malfunction!

**Death or permanent injury of the patient**

- Make sure no alarms are triggered at start-up.
- 

## Selftest

This test is executed automatically when the device is turned on.

(→ "Turn on" p. 120)

- 💡 *Make sure the environment is quiet.*
- 💡 *The selftest (starts when the device is turned on) and the associated hardware check must be run once a day.*

## System test

---

After the device has passed the selftest, the system test screen appears.

---



**WARNING**

System test not passed!

### **Death or permanent injury of the patient**

- Fix errors
  - Rerun the system test
- 



*If the system test is not passed, the operational readiness of the device is limited and may be operated only in the event of an emergency and not in the low or minimal flow range.*

*The cause of the failed system test must be remedied at the earliest opportunity.*



*If the system test is skipped 15 times, a red alarm "System test skipped too often" will appear. In addition, a red bar with the inscription "System test skipped too often" is displayed below the title bar. Only a passed system test will mute the alarm and delete the red bar.*

## Short checklist before start-up

---

This list is chained to the right side of the *leon plus*, but is also available as a copyable text "Short checklist before start-up". You will find the text at the end of this document.

This list must be processed manually. A description of the alarm tests required in the short checklist are available here:

(→ "Test of alarm functions" p. 134)

The short check (recommended by DGAI) is described here:

(→ "Short check (recommended by DGAI)" p. 95)

## Limited start-up option

-  *The device can be put into limited operation:*
- *if only AIR or only O<sub>2</sub> are available.*
  - *a system test block is passed with yellow.*

You should not put the device into operation if the O<sub>2</sub> supply gas pressure is below 2,8 kPa × 100 (bar).

## Turn on



The green LED below the plug icon on the keypad shows that mains voltage is available.



*The emergency dosing of theleon plus is only **not** released during the ongoing system test and during an ongoing ventilation.*



1. Keep the ON/OFF button on the keypad pressed down until the device confirms the entry with a sound signal.

**LÖWENSTEIN**  
medical

This calls up the boot screen. A self check of the hardware is run and the software is loaded.

State: **Selftest OK**

After approx. one minute, the **Status** message appears: Shows **Self check OK**. If the self check is not passed, the relevant message follows:

-  *Please make a note of the error number and notify a service technician authorised by Löwenstein Medical.*

After a successfully completed self check, the system test screen appears and the device is ready for operation.

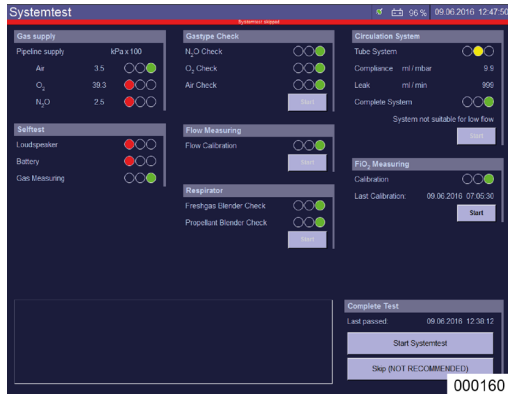

💡 *It is strongly recommended that the system test is executed.*

The system test screen appears with the following functions for selection:

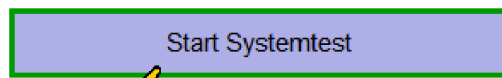

- Start of complete system test (→ "External fresh gas outlet before the system test" p. 125)



- Switch directly to standby (Skip system test Quick start (→ "Quick start" p. 149)



- Start individual system test block.

## System test

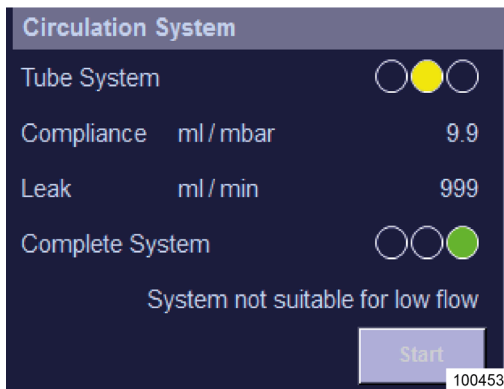
**General information****System test blocks**

The system test screen consists of six blocks.

The first block is produced in the selftest. The rerun of the test can only take place through a new selftest (device restart).

The **gas supply** block is continually renewed.

The remaining system test blocks can be started together or individually.

A system test block consists of:

- test name
- test content
- test result
  - traffic light display
  - alphanumeric value
- test start/stop button











*The system test blocks can be started individually only if the system test has been run completely once before.*



### Operating states of the system test block

Table 19: Operating states of the system test

Operating state	Traffic light	Button
Not run	 Traffic light fields empty	 Test can be started individually
Running	 Traffic light fields are alternately filled in white	 Test can be aborted   Test cannot be started
Result	 Completed, passed   Completed, operation possible   Completed, not passed	 Test can be started individually

## Results of the selftest

Table 20: Results of the selftest

	Test name	Description
<p>000163</p>	Gas supply (also updated in the system test)	<p>CGS pressures control: AIR, O<sub>2</sub>, N<sub>2</sub>O Traffic light: red, yellow or green possible</p> <p>10 L bottles control: O<sub>2</sub>, N<sub>2</sub>O or AIR Traffic light: red, yellow or green possible</p> <p> <i>Is only shown if configured in the service (→ "Gas supply" p. 111)</i></p>
<p>000164</p>	Selftest	<p>Check: Loudspeaker, battery, gas meter traffic light: red, yellow or green possible</p>

## O<sub>2</sub> emergency dosing during the system test

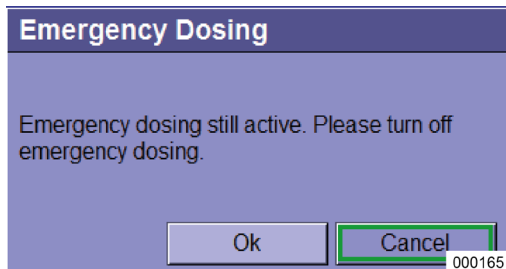

Before the complete system test is started, a check of whether the O<sub>2</sub> emergency dosing is switched off is carried out.

*During the ongoing system test the O<sub>2</sub> emergency dosing is switched off internally and cannot be activated*

## External fresh gas outlet before the system test

---

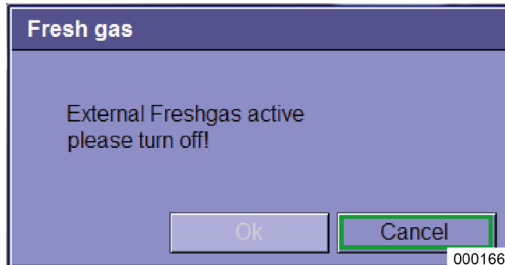

Before the full system test is started, a check verifies whether the external fresh gas outlet is active.

 *It is not possible to start the system test if the fresh gas outlet is open.*

## Start of the system test

---

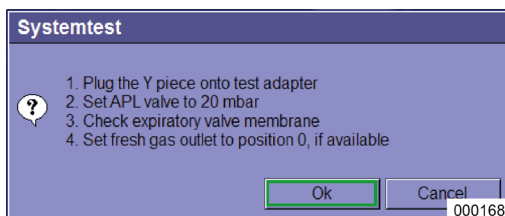

1. Activate the **Start** button on the bottom right of the system test screen and follow the prompts.

2. Put the y piece on the test adapter.

(→ "Connection of the ventilation bag" p. 86)

3. Set the APL valve to 20 mbar.

4. Check the expiratory valve membrane.

(→ "Change (dismantling) of the insp./exp. valve diaphragms" p. 267)

5. Set the fresh gas outlet to position 0, if available.

6. Confirm with **OK**.

The button label switches from **Start** to **Stop**. The system test can now be aborted by repressing the button.

## Skip/cancel system test (Quick start)

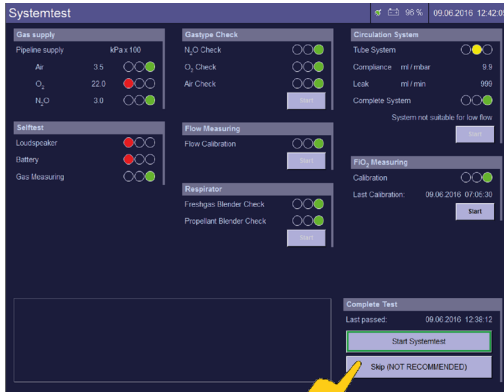

000170

### To skip:

1. Activate the **Skip** button (**NOT RECOMMENDED**) on the bottom right of the system test screen.

### Cancel:

1. Activate the **Stop** button on the bottom right of the system test screen while the system test is running.

The results of the last passed system test are reproduced.



If the system test is skipped or the system has switched into standby, despite the system test not having been passed, a red bar with the label **system test skipped** is displayed below the title bar.

- 💡 If the system test is skipped 15 times or has failed, a red alarm "System test skipped too often" will appear. In addition, a red bar with the inscription "System test skipped too often" is displayed below the title bar. Only a passed system test will mute the alarm and delete the red bar.

- 💡 It is strongly recommended that a system test is executed.

If the system test is not executed or is cancelled, it must be carried out at the next opportunity.



If no system test is carried out for 24 hours, a light blue bar under the title bar with the message **Last device restart > 24h. Please restart.** draws attention to the need to restart the device and conduct a system test.

## Back to the system test from standby

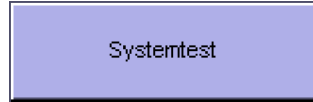

To get back to the system test from standby, use the **system test** button on the bottom left.

## Execution of the system test

Table 21: System test blocks

Execution	Test name	Description
	<p>Gastype check (is only active if N<sub>2</sub>O as carrier gas is activated in the service and the gastype check)</p> <p> This test can be switched off if configured correspondingly in Service (→ "Gas supply" p. 111).</p>	<p>Check of authenticity of AIR, O<sub>2</sub>, N<sub>2</sub>O gases</p> <ul style="list-style-type: none"> <li>Traffic light: red, yellow or green possible</li> </ul>
	<p>Flow measurement</p>	<p>Calibration of the flow sensors</p> <ul style="list-style-type: none"> <li>Traffic light: only red or green possible</li> </ul>
	<p>Respirator</p>	<p>Check of the fresh gas blender</p> <ul style="list-style-type: none"> <li>Traffic light: red, yellow or green possible</li> </ul> <p>Test of the drive gas generator:</p> <ul style="list-style-type: none"> <li>Traffic light: only red or green possible</li> </ul>
	<p>Circuit system</p>	<p>Determination of compliance</p> <ul style="list-style-type: none"> <li>Traffic light: red, yellow or green possible</li> </ul> <p>Determination of leakage</p> <ul style="list-style-type: none"> <li>Traffic light: red, yellow or green possible</li> </ul>

## Passed system test and display of values for compliance and leakage rate

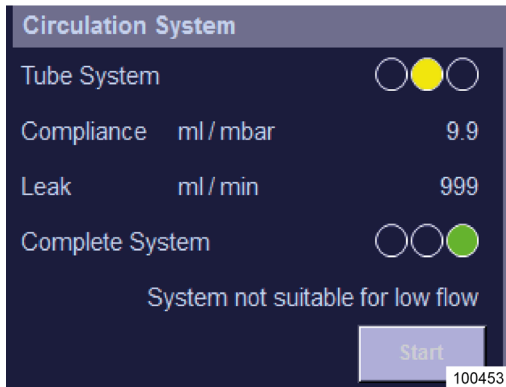

The time of the last passed test is displayed on the bottom right of the system test screen. Next to the values for compliance and leakage rates, the system test block for the circuit system displays whether the system is suitable for heavy, minimal or low flow.

1. Activate the **Continue (Standby)** button on the bottom right of the system test screen to switch the device to standby.

💡 *Even if the traffic light shows yellow (tube system leakage rate > 300 ml or circuit system leakage rate > 1000 ml), the system remains ready for operation. However, it is recommended that you remove the leak and repeat the test.*

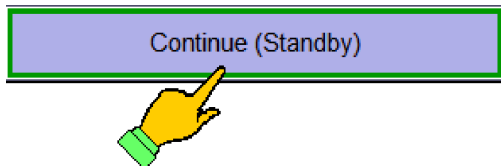

## System test not passed and detailed error display

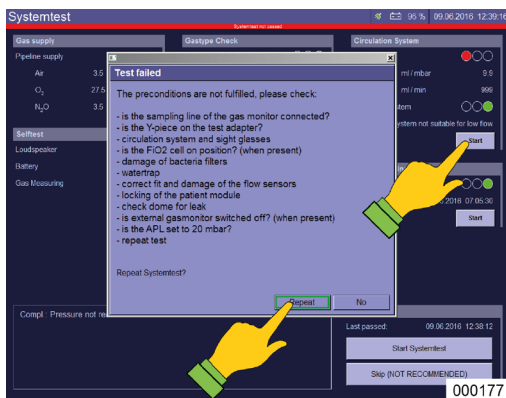

If a test fails, the description of the error that occurred in the test appears on the bottom left of the system test screen. Suggestions for troubleshooting the error are displayed in a window.

- The **Repeat** button in the error window repeats the full system test.
- The **Start** button in the failed system test block will only repeat the actual system test block.

💡 *If the system test is not passed, the cause must be fixed and the test repeated.*

💡 *If system test blocks are repeated individually, as they have not been passed, a system test that has not been passed with the subsequent passed system test blocks can be seen in the event log.*

## Display of values for compliance and leakage rate

Systemtest	
Last passed:	09.06.2016 07:13:11
Skipped:	0 / 15
Circulationsystem check	
Last performed:	09.06.2016 07:13:10
Tightness:	System not suitable for low flow
Compliance:	9.9 ml / mbar at 30 000178

The values for compliance and leakage rate with date and time can be seen at any time in standby.

The date of the last passed system test and the number of skipped system tests is always displayed.

In addition, the date and the results of the last system test executed is displayed.

If the system is not suitable for low or minimal flow, this is displayed stating the determined leakage rate.

## Repeating individual system test blocks

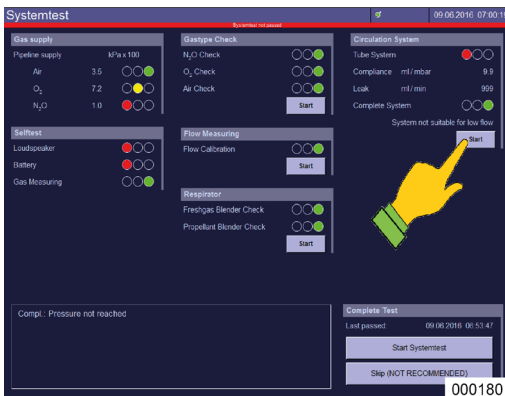

If the system test is not passed, the system test blocks that have not passed can be repeated in individual tests. If they are subsequently passed, the full system test counts as having passed. If a system test block does not pass, the red bar remains.

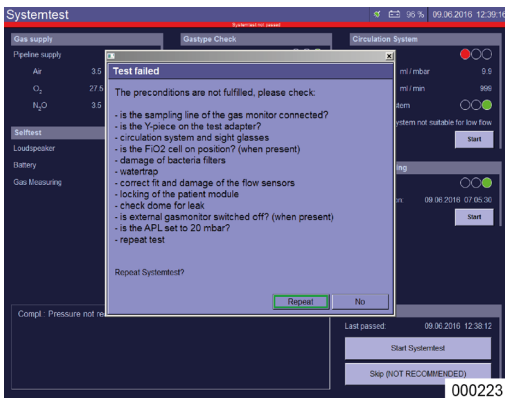

If a switch is made from standby to the system test screen (e.g. to redetermine compliance after changing the patient tube system), an individual test is started and not passed, a yellow bar with the label **“Individual Test Not Passed”** appears.

## Tightness of tube system and full system

Table 22: Tube system tightness

Value in ml/min	Status	Traffic light
<150	Tight	Green
≤300	Not suitable for minimal flow	Green
>300	Not suitable for low flow	Yellow

Table 23: Total system tightness

Value in ml/min	Status	Traffic light
<500	Tight	Green
≤1000	Not suitable for minimal flow	Green
>1000	Not suitable for low flow	Yellow







## FiO<sub>2</sub> calibration not passed

---

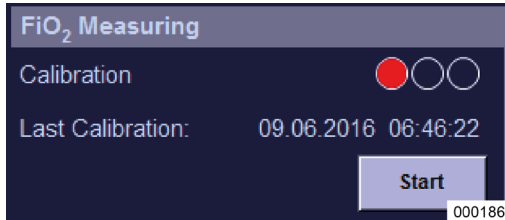

If the test is failed, the “traffic light” remains on red and the exact description of the error that occurred in the test appears on the bottom left of the system test screen.

💡 *FiO<sub>2</sub> calibration error messages*  
(→ "Error search FiO<sub>2</sub> calibration" p. 248)

## Alarm test

### General information

---

💡 *The manufacturer recommends a daily check for proper functioning.*

- *once a day for routine daily work*
- *for each planned operation in standby time*
- *if possible, also in an emergency and in the event of unplanned, fast deployment.*

**1.** Set the alarm limits of the monitored data in accordance with the following table.

**2.** Start the given test.

All of the triggered alarms are stored in the alarm log and can (→ "Alarm log" p. 206) be seen here.

## Test of alarm functions

The following description of the procedure for checking the alarm functions is based on the assumption that the tests are carried out completely without interruption.

If the test is interrupted, points I - VI should be observed at the start of individual tests and points VII and VIII or IX and X at the end.

Table 25: Checking the alarm functions



Alarm	Setting the alarm limits	Test
		<ol style="list-style-type: none"> <li>I. Ensure that the anaesthetic gas aspirator is connected and in operation.</li> <li>II. Disconnect the patient adapter of the gas measurement from the Y-connector and replace the Y-connector on the test adapter.</li> <li>III. Pull the ventilation tube off the ventilation bag connection cone (→ "Connection for ventilation tubes, anaesthesia gas scavenging system and ventilation bag" p. 65), plug the patient adapter of the gas measurement onto the connection cone and plug the ventilation tube with bag onto the patient adapter of the gas measurement.</li> <li>IV. Set the APL valve to SP.</li> <li>V. Select AIR as carrier gas.</li> <li>VI. Start the <b>MAN/SPONT</b> form of ventilation.</li> </ol>
insp. O <sub>2</sub> [%] low	>50 %	<ol style="list-style-type: none"> <li>1. Set a fresh gas flow of 10 L and 25 % O<sub>2</sub>.</li> <li>2. Set the alarm limit (low).</li> </ol>
FiO <sub>2</sub> [%] low	>50 %	<ol style="list-style-type: none"> <li>3. Squeeze the bag several times until the alarm is triggered.</li> </ol>
Volatile anaesthetics [%] low	largest possible value	<ol style="list-style-type: none"> <li>1. Set the anaesthetic vaporiser to approx. 2%.</li> <li>2. Set the alarm limit (low).</li> <li>3. Squeeze the bag several times until the alarm is triggered.</li> <li>4. Set the anaesthetic vaporiser to 0%.</li> </ol>

Table 25: Checking the alarm functions

O <sub>2</sub> insp. [%] high	<50 %	<ol style="list-style-type: none"> <li>1. Set a fresh gas flow of 10 L and 100 % O<sub>2</sub>.</li> <li>2. Set the alarm limit (high).</li> <li>3. Squeeze the bag several times until the alarm is triggered.</li> </ol>
FiO <sub>2</sub> [%] high	<50 %	
Volatile anaesthetics [%] low	smallest possible value	<ol style="list-style-type: none"> <li>1. Set the anaesthetic vaporiser to approx. 2%.</li> <li>2. Set the alarm limit (low).</li> <li>3. Squeeze the bag several times until the alarm is triggered.</li> <li>4. Set the anaesthetic vaporiser to 0%.</li> </ol>
<b>VII.</b> Switch to standby.		
<b>VIII.</b> Restore the test set-up for the system test.		
		<ol style="list-style-type: none"> <li>1. Remove the patient adapter of the gas measurement with Y-connector from the test adapter.</li> <li>2. Attach a ventilation filter to the patient adapter of the gas measurement.</li> </ol>
exp. CO <sub>2</sub> [%] low	>7.0 %	<ol style="list-style-type: none"> <li>1. Set the alarm limit (low).</li> <li>2. Breathe out into the filter several times.</li> <li>3. Wait until the alarm is triggered.</li> </ol>
insp. CO <sub>2</sub> [%] high	<0.5 %	<ol style="list-style-type: none"> <li>1. Set the alarm limit (high).</li> <li>2. Breathe out into the filter several times.</li> <li>3. Wait until the alarm is triggered.</li> </ol>
exp. CO <sub>2</sub> [%] high	<1.0 %	
Apnoea		After the test of the alarm limits (high), wait until the alarm is triggered.
		<ol style="list-style-type: none"> <li>1. Switch to standby.</li> <li>2. Activate the <b>Reset To Default Settings</b> button. (→ "Load default settings" p. 143)</li> <li>3. Connect a commercial artificial lung to the y-piece.</li> <li>4. Start volume-controlled ventilation with <math>f = 5/\text{min}</math>, <math>V_{Ti} = 500 \text{ ml}</math>.</li> </ol>
MV [l/min] low	>5 l/min	<ol style="list-style-type: none"> <li>5. Set the alarm limit (low).</li> <li>6. Wait until the alarms are triggered.</li> </ol>
VTe [ml] low	>1000 ml	
MV [l/min] high	<2 l/min	<ol style="list-style-type: none"> <li>7. Set the alarm limit (high).</li> <li>8. Wait until the alarms are triggered.</li> </ol>
PPeak [mbar]	<20 mbar	

Table 25: Checking the alarm functions

		<ol style="list-style-type: none"> <li>1. Switch to standby.</li> <li>2. Activate the <b>Reset To Default Settings</b> button. (→ "Load default settings" p. 143)</li> </ol>
Disconnection	/	<ol style="list-style-type: none"> <li>3. Connect a commercial artificial lung to the y-piece.</li> <li>4. Start mechanical ventilation and withdraw the artificial lung.</li> <li>5. Wait until the alarm is triggered.</li> </ol>
Decompression during expiration	/	<ol style="list-style-type: none"> <li>3. Connect a commercial artificial lung to the y-connector.</li> <li>4. Set a fresh gas flow of 5 L, close the connection to the AGSS on the patient module and start pressure-controlled ventilation.</li> <li>5. Wait until the alarm is triggered.</li> </ol>
CGS	/	<ol style="list-style-type: none"> <li>3. Pull the supply plug for AIR, O<sub>2</sub> and N<sub>2</sub>O from the supply couplings.</li> <li>4. Wait until the alarms are triggered.</li> </ol>
		Restore the test set-up for the system test.

-  **IX.** Irrigate the system thoroughly.
- X.** Activate the **Reset To Default Settings** button.  
(→ "Load default settings" p. 143)
-  **DO NOT FORGET:** Replace the patient adapter of the gas measurement on the Y-connector.

Irrespective of the short check list on the device, the DGAI recommends a short check before a patient is connected to an anaesthesia device. The device's short check is an additional safety measure during operation or in emergency situations; this is absolutely necessary, but does not replace the thorough function check of the devices including accessories during the morning's start-up.

**Basically, this always applies when there are problems with ventilation:**

- quickly reach for the breathing bag which, as a fallback option, must be placed at every anaesthesia workplace and, if necessary, remove the artificial airway.

This short check encompasses three parts:

1. Check the ventilation system for
  - gas flow function ("PaF test" pressure and flow)
  - correct installation
  - larger leakages or obstructions

Select the ventilation mode "Man/Spont." on the anaesthesia device and set the APL to 30 mbar. Close the patient connection (Y-connector). Fill the ventilation system and manual breathing bag with the O<sub>2</sub> flush. With manual compression, the manual breathing bag must not empty ("pressure"). When the patient connection is reopened, a clearly noticeable gas flow must escape ("flow").

In addition, at least a few manual/assisted breaths are always given before starting mechanical ventilation.

2. The FiO<sub>2</sub> or O<sub>2</sub> measurement serves to verify that the colourless and odourless gas mixture supplied to the patient contains enough oxygen.
3. Capnometry serves to verify that the lungs are ventilated.

In the event of any abnormalities, the connection between the patient and the anaesthesia device is disconnected again and systematic troubleshooting is initiated. Meanwhile, ventilated patients are ventilated with the obligatory separate manual breathing bag.

**Power off**



The device can only be turned off from standby.

1. Keep the **ON/OFF** button on the keypad pressed down until the device confirms the entry with a sound signal.

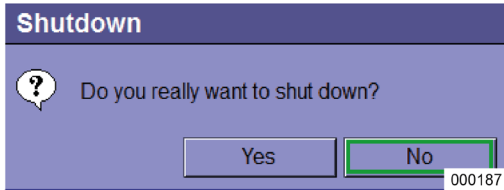

2. Confirm the screen dialogue on the touchscreen with **YES**.

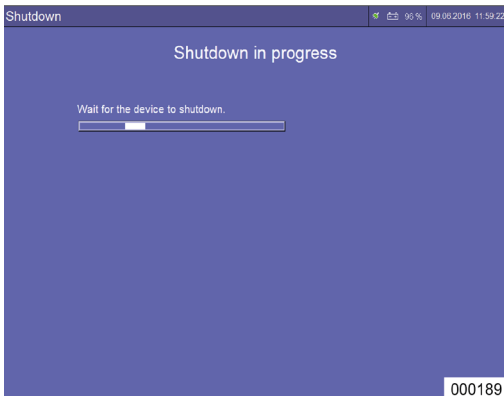
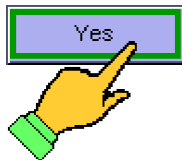

While system data are saved in the background, a running bar appears on the screen.

3. Wait until the device switches itself off.

4. Separate the device from the central gas supply (disconnect the supply plug from the wall connection or put it into park position) to prevent the possibility of the piping system becoming dirty.

 *If the **ON/OFF** button is pressed while ventilation is running, the (→ "To switch to standby (stop ventilation)" p. 161) standby dialogue appears. To completely separate from the mains power, pull the mains plug.*



## O<sub>2</sub> emergency dosing during shutdown of the device

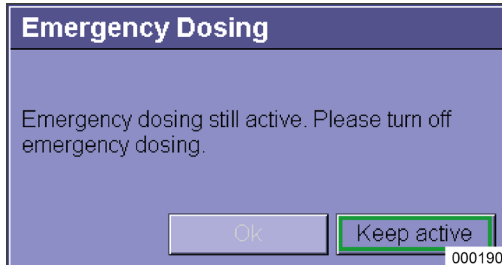

If the device shuts down and the emergency dosing is switched on the following dialogue appears:

**“Emergency dosing still active. Please turn off emergency dosing.”** The **OK** button is inactive.

1. If you wish to continue to ventilate the patient with the device switched off, confirmed the dialogue with the **keep active** button. Otherwise, close the emergency dosing.

The **OK** button becomes active.

2. Confirm the dialogue with the **OK** button.

In both cases the further shutdown process takes place.

## 8. Ventilation

### General information

#### Compliance compensation

Part of the tidal volume, called compliance volume, does not reach the patient due to compression in the patient module and into the patient tubes during inspiration. In volume-controlled ventilation, the *leon plus* therefore carries out a compliance compensation of the tidal volume by adding the compliance volume to the set tidal volume. The compliance volume in the patient tubes is taken into account during volume measurement. During pressure-controlled ventilation, the compliance volume during expiration is taken into account.

#### Patient categories



IBW  
30  
kg

You can choose between two patient categories:

- child
- adult

Different default settings are stored for particular categories. Some ventilation parameter setting options are limited, depending on the category.



*The lower the tidal volume, the bigger the constant share of the compliance volume becomes. Therefore, use child tube systems for children to lower the total gas volume of the system, if necessary.*

## Weight (IBW)

---



You can enter the ideal body weight [kg] of the patient. The presets for the following ventilation parameters are calculated according to the entry:

- Minute volume MV [l/min]
- Breath volume (insp.)  $V_{Ti}$ ,  $V_{TG}$  [ml]
- Frequency  $f$  [1/min]

💡 *The lower the tidal volume, the bigger the constant share of the compliance volume becomes. Therefore, use child tube systems for children to lower the total gas volume of the system, if necessary.*

Table 26: Setting range and increments of the weight entry

	Range	Increment
Weight	1-5	0.1
	5-50	1
	50-99	5

### Ventilation parameters with weight entry

If the ventilation parameters are preset by entering the weight, the restrictions of the setting options of the ventilation parameters through the patient categories are lifted.

Table 27: Setting range and increment of the ventilation parameters with weight entry

Ventilation parameters	Ventilation			
	volume-controlled		pressure-controlled	
	Range	Increment	Range	Increment
V <sub>Ti</sub> [ml] V <sub>TG</sub> [ml] (optional)	3-20 (optional)	1	OFF, 3-20 (optional)	1
	20-50	2	20-50	2
	50-100	5	50-100	5
	600-1000	10	600-1000	10
	1000-1600	50	1000-1600	50
P <sub>max</sub> [mbar]	10-80	1	5-60	1
P <sub>insp.</sub> [mbar]	5-60	1	5-60	1
Frequency [1/min]	4-80 (100)	1	4-80 (100)	1
I:E	1:4-4:1	0.1	1:4-4:1	0.1
T <sub>insp.</sub> [s]	0.2-10	0.1	0.2-10	0.1
PEEP [mbar]	OFF, 1-20	1	OFF, 1-20	1
Plateau [%]	OFF, 10-50	5	10-90	5
Trigger [l/min]	0.1-0.5	0.1	0.1-0.5	0.1
	0.6-5	0.5	0.6-5	0.5
	6-10	1	6-10	1
Backup [s]	4-10	2	4-10	2
	10-15	5	10-15	5
	15-45	15	15-45	15

Table 28: Calculation of the IBW

IBW	Size [cm]	IBW [kg] calculation formula
IBW children	50...171	$= 2.05 \times e^{(0.02 \times \text{size [cm]})}$
IBW adult male	152...250	$= 50 + 2.3 \times (\text{size [cm]} - 152.4) \div 2.54$
IBW adult female	152...250	$= 45.5 + 2.3 \times (\text{size [cm]} - 152.4) \div 2.54$

Calculation formulas according to:

- Traub SL, Comparison of methods of estimating creatine clearance in children
- Pai MP, The origin of the "ideal" body weight equations

## Load default settings

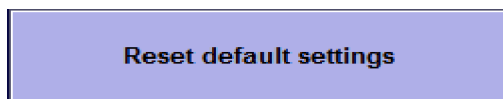

In standby, the **Reset to Default Settings** button is located on the bottom right of the screen.

The basic settings are designated as default settings, which the device shows when it is switched on.

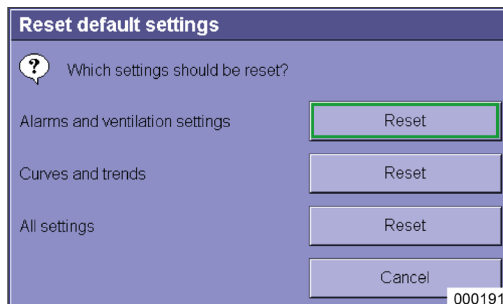

The following can be reset to default:

- Alarms, ventilation parameters and fresh gas blenders
- Curves, trend curves, tabular trend
- All settings

 *Only the settings of the currently selected patient category are reset.*

## Behaviour of the $P_{\text{insp}}$ . Setting upon change to the PEEP settings

Changing the PEEP setting does not influence the set  $P_{\text{insp}}$ . Setting (in the PCV form of ventilation). Minimum difference between PEEP and  $P_{\text{insp}}$ . is 5 mbar.

 *When increasing the PEEP settings, the  $P_{\text{insp}}$ . setting must also be increased correspondingly, as otherwise it would lead to a lowering of the  $V_{\text{Ti}}$  or MV.*

## Moisture in the ventilation system

If long anaesthesias are predominantly carried out in the minimal and low flow range, increased moisture from the patient gases and water freed during CO<sub>2</sub> absorption gathers in the ventilation system.

The excess moisture condenses at the coldest points in the ventilation system. As the patient module is heated, this is the tube to the ventilation bag and bellows. The water in the tube can also be removed during operation by briefly pulling it out and emptying it. The bellows can only be emptied when the patient module is folded down.

By interposing water traps in the ventilation tubes, some of the moisture can be trapped. The water traps must be suspended at the lowest point (between the y-piece, the patient and the patient module) of the ventilation tubes. To ensure this, use ventilation tubes of different lengths, if necessary.

 *Extreme moisture in the ventilation system can falsify the gas measurement.*

## Low flow and minimal flow

Table 29: Conditions for low or minimal flow suitability

Range	Settable fresh gas flow	Leakage rate of the tube system
Low flow	≤1000 l/min	≤300 ml/min
Minimal flow	≤500 ml/min	≤150 ml/min

A system is described as suitable for low or minimal flow if the following conditions are fulfilled:

If the sum of the gas intake of the patient and the leakage rate of the ventilation system is bigger than the fresh gas flow, the ventilation system empties itself. The fresh gas flow must then be adapted accordingly. A fresh gas flow that is too high escapes through the excess diaphragm in the AGSS. The fill state of the ventilation system corresponds to the fill state of the ventilation bag serving as a reservoir.

### Fresh gas setting

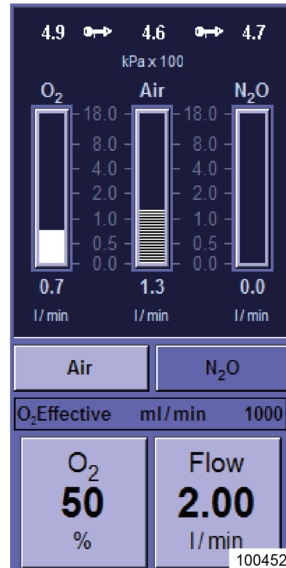

Here, the following occurs:

- the selection of the carrier gases AIR or N<sub>2</sub>O
- the setting of the percentage share of oxygen on the fresh gas flow
- the setting of the fresh gas flow
- econometer

Features:





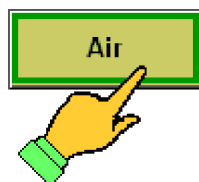

- the setting range is 0.2 l/min–18 l/min (except for HLM)
- AIR or N<sub>2</sub>O are available as carrier gas
- ensuring of an O<sub>2</sub> minimum flow of 0.2 l/min (except for HLM)
- ensuring of an O<sub>2</sub> concentration in the O<sub>2</sub>/N<sub>2</sub>O blend of at least 25% (ratio system)
- N<sub>2</sub>O block in the event of O<sub>2</sub> shortage
- automatic switch to 100% AIR with O<sub>2</sub> shortage with fresh gas flow remaining the same
- automatic switch to O<sub>2</sub> with AIR shortage with fresh gas flow remaining the same
- automatic switch to 100% O<sub>2</sub> with N<sub>2</sub>O shortage with fresh gas flow remaining the same
- audible and visual alarm in the event of O<sub>2</sub>, AIR or N<sub>2</sub>O shortage
- O<sub>2</sub> effective [ml/min] or [l/min] (quantity 100% oxygen in the set fresh gas)
- display of an economic fresh gas flow

The set gas amount is displayed under the relevant tube in l/min. There is a graphic display of the amount in the tube as a bar graph.

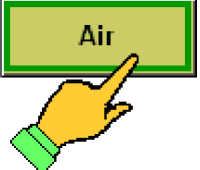
If not confirmed, presets (yellow) are closed again after 10 seconds

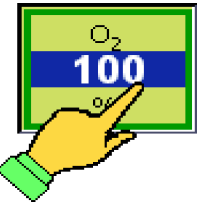
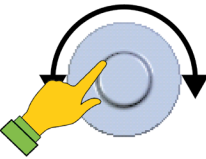

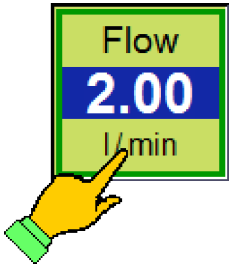
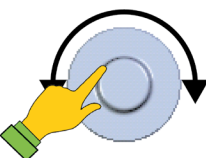
1. Select the fresh gas blender button in the window to implement the settings.

- 
- 
- 
- 
- 
- 
- 
- 
- 
1. Select the button for the **carrier gas** (AIR or N<sub>2</sub>O) in the fresh gas blender window.
  2. Confirm the entry.
  3. Select the **O<sub>2</sub>** button.
  4. Set the **percentage share of O<sub>2</sub>** to the fresh gas flow.
  5. Confirm the entry.
  6. Select the **flow** button.
  7. Set the **fresh gas flow**.
  8. Confirm the entry.

 *The fill state of the ventilation system corresponds to the fill state of the ventilation bag serving as a reservoir. If the ventilation bag empties, the fresh gas supply must be increased accordingly. Presetting the fresh gas is also possible in standby. If the fresh gas blender fails its control elements become inactive. Then ensure the fresh gas flow through the O<sub>2</sub> emergency supply*



## Fresh gas ecometer

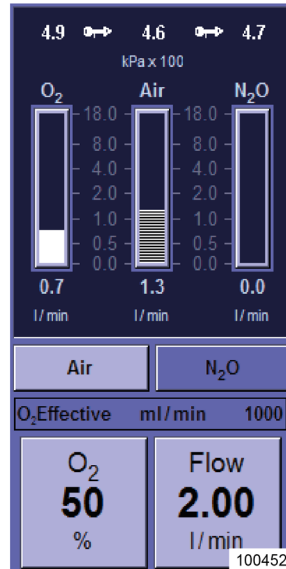

On the right of the fresh gas blender window there is a three-part tube. Depending on the height of the O<sub>2</sub> fresh gas flow, the tube is filled in red, green or yellow.

### Fresh gas shortage (red):

$$O_2\text{Effektiv} < \dot{V}_{O_2\text{eff}} \times X_1$$

The set O<sub>2</sub> fresh gas flow is lower than the total oxygen consumption in the system multiplied by a factor x<sub>1</sub>.

### Fresh gas economic (green):

$$O_2\text{Effektiv} \geq \dot{V}_{O_2\text{eff}} \times X_1$$

The set O<sub>2</sub> fresh gas flow is the same or higher than the total oxygen consumption in the system multiplied by a factor x<sub>1</sub>.

(Maximum is limit to yellow)

### Fresh gas uneconomic (yellow):

$$O_2\text{Effektiv} > \dot{V}_{O_2\text{eff}} \times X_2$$

The set O<sub>2</sub> fresh gas flow is higher than the total oxygen consumption in the system multiplied by a factor x<sub>2</sub>.

$\dot{V}_{O_2\text{eff}}$  = total oxygen consumption in the system (sum from O<sub>2</sub> uptake of the patient and leakage of the system)

x<sub>1</sub> and x<sub>2</sub> = factors that can be changed in the service to individually adjust the threshold from red to green and from green to yellow

## Borderline fresh gas settings

---

-  For **borderline settings** or in the event of a shortage of supply gases (CGS), consider:
- smallest flow that can be set is 0.2 l/min (except for HLM)
  - minimum O<sub>2</sub> flow in the fresh gas is 0.2 l/min (except for HLM)
  - for the reasons given above, the O<sub>2</sub> increases over the N<sub>2</sub>O concentration for a fresh gas flow under 0.8 l/min.
  - for the reasons given above, the dosing of 21% O<sub>2</sub> is not possible below 1 l/min
  - the O<sub>2</sub> concentration in the O<sub>2</sub>/N<sub>2</sub>O blend is ≥ 25 % (ratio system)
  - N<sub>2</sub>O block with O<sub>2</sub> shortage < 0.6-0.8 kPa × 100 (bar)
  - with O<sub>2</sub> shortage < 2.8 kPa × 100 (bar) automatic switch to AIR with the fresh gas flow remaining the same
  - with AIR shortage < 2.8 kPa × 100 (bar) automatic switch-over to O<sub>2</sub> (100 %) with the fresh gas flow remaining the same
  - with N<sub>2</sub>O shortage < 2.8 kPa × 100 (bar) automatic switch-over to O<sub>2</sub> (100 %) with the fresh gas flow remaining the same

## Setting of the anaesthetic vaporiser

-  Please operate the anaesthetic vaporiser in accordance with its user manual.

## Quick start

In the case of emergency, the device is ready for ventilation immediately without the execution of the system test.



**CAUTION**

Quick start, system test is not executed.

### Some functions not checked

Pay greater attention.

A red bar is shown in the title bar with the message "System test skipped"



**WARNING**

Quick start: System test is not executed

### Some functions not checked

Low or minimal flow are not allowed to run



*The O<sub>2</sub> emergency dosing of the leon plus is active in the turned-off state. If it is opened before the start and if the system test is skipped, it remains active until a ventilation is started.*

*The O<sub>2</sub> emergency dosing is **not** active during the ongoing system test.*

1. Turn on the leon plus as follows:

## Manual operation during the boot process and the selftest

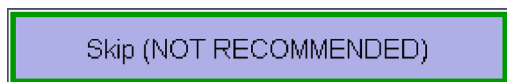
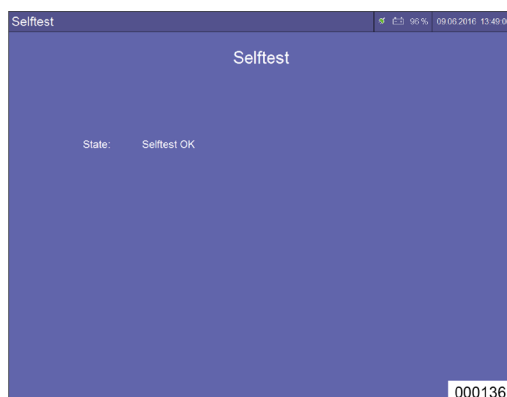

1. Set the APL valve to the maximum desired ventilation pressure.
2. Set the O<sub>2</sub> emergency dosing to the desired fresh gas flow.
3. Set the anaesthetic vaporiser to the desired concentration.
4. Ventilate the patient manually for a short time. After approx. 1 minute, monitoring and the controlled form of ventilation of the leon plus are available.

You can switch from the system test screen directly to standby (skip system test)



*Skipping the system test is not recommended.*



*Set the O<sub>2</sub> emergency dosing to 0.*

## Execute quick start

Child

Adult

IBW  
30  
kg

1. To **quick start mechanical ventilation**, first select the patient category:
  - Child
  - Adult
  - Weight

PCV



2. Carry out the fresh gas setting, as described in the chapter (→ "Fresh gas setting" p. 145).
3. Select the **Form Of Ventilation** button.



4. Confirm the selection.

Plateau  
20  
%

5. Select the **Ventilation Parameters** button.

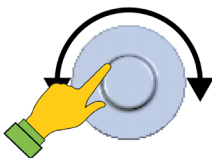

6. Set the parameter.
7. Confirm the entry.

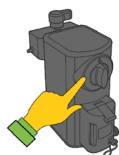

8. Set the anaesthetic vaporiser to the desired concentration.



9. Start ventilation.

## Forms of ventilation

**Manual ventilation****Start a MAN/SPONT manual/spontaneous ventilation**

Child

Adult

IBW  
30  
kg

1. To start a manual ventilation or spontaneous breathing, first select the patient category:
  - Child
  - Adult
  - Weight

2. Carry out the fresh gas setting, as described in the chapter (→ "Fresh gas setting" p. 145).

3. Select the **MAN/SPONT** button in the form of ventilation window.



4. Set the APL on the patient module to a value corresponding to the pressure limit (e.g. 20 Pa × 100 (mbar)).



5. Set the anaesthetic vaporiser to the desired concentration.

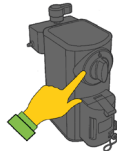

6. Start the monitoring and ventilate the patient with the ventilation bag.



7. Activate the O<sub>2</sub> flush on the front of the device to fill the system quickly.

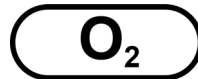

Table 30: Setting parameters, setting range and increment of the MAN/SPONT form of ventilation.

Ventilation parameters	Child		Adult	
	Range	Increment	Range	Increment
Fresh gas flow [l/min]	0.2-1	0.05	0.2-1	0.05
	1-18	0.1	1-18	0.1
Fresh gas O <sub>2</sub> [% from fresh gas flow]	25(21)-100	1	25(21)-100	1
V <sub>Ti</sub> [ml]	/	/	/	/
V <sub>TG</sub> [ml] (optional)	/	/	/	/
P <sub>max</sub> [mbar]	/	/	/	/
P <sub>insp.</sub> [mbar] (is set over APL)	0-90	free	0-90	free
Frequency [1/min]	/	/	/	/
I:E	/	/	/	/
T <sub>insp.</sub> [s]	/	/	/	/
PEEP [mbar]	/	/	/	/
Plateau [%]	/	/	/	/
Trigger [l/min]	/	/	/	/
Backup [s]	/	/	/	/

O<sub>2</sub> fresh gas parameters [% of fresh gas flow], minimal O<sub>2</sub> concentration fresh gas blender:

- with carrier gas AIR 21 %
- with carrier gas N<sub>2</sub>O 25 %

### HLM (ventilation using a heart-lung machine)

If the *leon plus* is operated together with a heart-lung machine, the HLM form of ventilation is available. The HLM form of ventilation is the equivalent of the MAN/SPONT form of ventilation, except that here the monitoring of all of the limit values (except for CPAP) is switched off. Along with the CPAP (continuous positive airway pressure) five further measured values are displayed:

- Minute volume MV
- Breath volume (exp.)  $V_{Te}$
- Ventilation pressure  $P_{Peak}$
- Plateau pressure  $P_{Plateau}$
- $Freq.CO_2$



**WARNING**

Alarms switched off!

#### Risk of oxygen deficiency

- Be extra vigilant during the ventilation.



 *If no breath can be detected for 30 seconds, change the monitoring value to --- (except for CPAP).*



1. Set the APL on the patient module to a value corresponding to the pressure limit (e.g.  $10 \text{ Pa} \times 100 \text{ (mbar)}$ ).
2. Carry out the fresh gas setting, as described in the chapter ( $\rightarrow$  "Fresh gas setting" p. 145) (0 L/min possible).



3. Select the **HLM** button in the form of ventilation window.



4. Start the monitoring.
-  *The CPAP sets itself.*



5. Set the CPAP alarm.

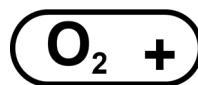

6. Activate the  $O_2$  flush on the front of the device to reach the CPAP quickly.

Table 31: Setting parameters, setting range and increment of the HLM form of ventilation.

Ventilation parameters	Child		Adult	
	Range	Increment	Range	Increment
Fresh gas flow [l/min]	OFF above 0.2-1	0.05	OFF above 0.2-1	0.05
	1-18	0.1	1-18	0.1
Fresh gas O <sub>2</sub> [% from fresh gas flow]	25(21)-100	1	25(21)-100	1
V <sub>Ti</sub> [ml]	/	/	/	/
V <sub>TG</sub> [ml]	/	/	/	/
P <sub>max</sub> [mbar]	/	/	/	/
P <sub>insp.</sub> [mbar] (is set over APL)	0-90	free	0-90	free
Frequency [1/min]	/	/	/	/
I:E	/	/	/	/
T <sub>insp.</sub> [s]	/	/	/	/
PEEP [mbar]	/	/	/	/
Plateau [%]	/	/	/	/
Trigger [l/min]	/	/	/	/
Backup [s]	/	/	/	/

O<sub>2</sub> fresh gas parameters [% of fresh gas flows], minimal O<sub>2</sub> concentration fresh gas blender:

- with carrier gas AIR 21%
- with carrier gas N<sub>2</sub>O 25%



### MON mode

For regional anaesthetics (with adequate spontaneous breathing) or when monitoring an awake patient, the *leon plus* provides the MON (monitoring) form of ventilation. The patient can be supplied with O<sub>2</sub> via a mask and the internal O<sub>2</sub> outlet or an external O<sub>2</sub> outlet. Fresh gas cannot be given via the blender. The monitoring of all of the limit values (except for CPAP, insp.O<sub>2</sub>, exp. CO<sub>2</sub> and Freq<sub>CO2</sub>) is switched off. Connecting the gas meter of the device to the ventilation mask is a prerequisite for monitoring and displaying the monitoring values (except CPAP).

Six measured values are displayed:

- Minute volume MV
- Breath volume (exp.) V<sub>Te</sub>
- Ventilation pressure P<sub>Peak</sub>
- Plateau pressure P<sub>Plateau</sub>
- Freq<sub>CO2</sub>
- CPAP



*In the MON form of ventilation it is not possible to set ventilation parameters.*

**WARNING**

Various patient alarms switched off!

**Risk of oxygen deficiency**

Be extra vigilant during the ventilation.

If CO<sub>2</sub> has not yet been measured, the monitoring values (except for CPAP) display --.-.



1. Select the **MON** button in the form of ventilation window.



2. Start the monitoring.

Fresh gas cannot be given via the fresh gas blender.

Not all alarm limits are monitored during MON Mode

Connect the gas measurement on the respiratory mask

Connect the respiratory mask with an O<sub>2</sub> output

Open the O<sub>2</sub> output

000192

3. Follow the prompts on the screen:

- Connect the multi gas analyser to the respiratory mask.
- Connect the respiratory mask to an O<sub>2</sub> outlet.
- Open the O<sub>2</sub> outlet.

## Mechanical ventilation

### Selection of a mechanical form of ventilation

The *leon plus* provides the following mechanical forms of ventilation:

- volume-controlled ventilation: IMV
- pressure-controlled ventilation: PCV
- synchronised intermittent mandatory ventilation: S-IMV
- pressure-controlled synchronised ventilation: S-PCV
- pressure-supported ventilation: PSV

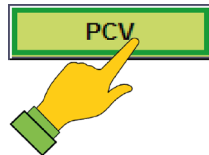

1. Select the **Form Of Ventilation** button.

### Ventilation parameters



#### Setting the ventilation parameters

1. Select the **Ventilation Parameters** button.

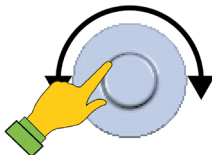

2. Set the parameters.
3. Confirm the entry.

## Buttons for setting ventilation parameters

## General IMV, PCV

Freq <b>10</b> bpm	I:E <b>1:2</b>	Plateau <b>10</b> %	PEEP <b>5</b> mbar	Freq.	Ventilation frequency
				I:E	Time ratio of inspiration to expiration
				Plateau	Percentage share of inspiration time in which the ventilation pressure in the patient's lungs is kept constant
				PEEP	Positive pressure that is maintained in the patient tube system during expiration

## IMV (additional)

$V_{Ti}$ <b>180</b> ml	$P_{Max}$ <b>25</b> mbar	$V_{Ti}$	inspiratory ventilation volume that should be reached per breath
		$P_{max}$	Pressure limit from which the plateau is developed

## PCV (additional)

$P_{Insp}$ <b>14</b> mbar	$V_{TG}$ <b>Off</b> mL	$P_{Insp.}$	inspiratory pressure that should be reached per breath
		$V_{TG}$	Tidal volume guarantee (optional)
$P_{Max}$ <b>21</b> mbar	$V_{TG}$ <b>500</b> mL	$P_{max}$	Pressure limit from which the plateau is developed (optional)

## General S-IMV, S-PCV, PSV

PEEP <b>5</b> mbar	Trigger <b>1.5</b> l/min	Trigger	flow produced by the patient from which a mechanical breath is triggered
		PEEP	Positive pressure that is maintained in the patient tube system during expiration

## S-IMV (additional)

Freq <b>12</b> bpm	$T_{Insp}$ <b>1.7</b> s	Plateau <b>10</b> %	$V_{Ti}$ <b>500</b> ml	$P_{Max}$ <b>35</b> mbar	Freq.	Ventilation frequency
					$T_{insp.}$	Time for the inspiration
					Plateau	Percentage share of inspiration time in which the ventilation pressure in the patient's lungs is kept constant
					$V_{Ti}$	inspiratory ventilation volume that should be reached per breath
					$P_{max}$	Pressure limit from which the plateau is developed

## Buttons for setting ventilation parameters

## S-PCV (additional)

Freq <b>10</b> bpm	T <sub>Insp</sub> <b>2.0</b> s	Plateau <b>40</b> %	P <sub>Insp</sub> <b>12</b> mbar	Freq.	Ventilation frequency
				T <sub>insp.</sub>	Time for the inspiration
				P <sub>insp.</sub>	inspiratory pressure that should be reached per breath
				Plateau	percentage share of inspiration time in which the ventilation pressure in the patient's lungs is kept constant

## PSV (additional)

P <sub>Insp</sub> <b>10</b> mbar	Backup <b>15</b> s	Manual Breath	P <sub>insp.</sub>	inspiratory pressure that should be reached per breath
			Backup	Length of apnoea period until the <i>leon plus</i> triggers a mechanical breath independently
			Manual breath	the user can trigger a mechanical breath him/herself

## Start of a mechanical ventilation

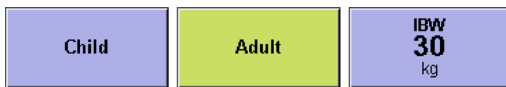

1. To start a mechanical ventilation, first select the patient category:
  - Child
  - Adult
  - Weight

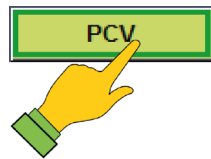

2. Carry out the fresh gas setting, as described in the chapter (→ "Fresh gas setting" p. 145).
3. Select the **Form Of Ventilation** button.



4. Confirm the selection.



5. Select the **Ventilation Parameters** button in the form of ventilation/parameters window.

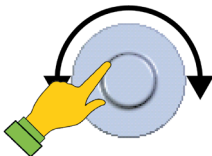

6. Set the parameter.



7. Confirm the entry.

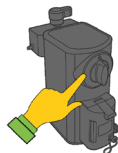

8. Set the anaesthetic vaporiser to the desired concentration.



9. Start ventilation.

### To change a form of ventilation

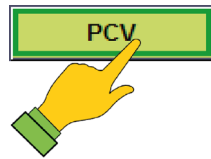

Select the button of the new form of ventilation (highlighted in yellow).



Start the new form of ventilation with the unchanged parameter settings.

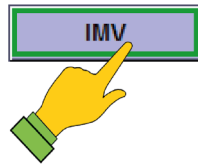

 Alternatively, you can keep the active form of ventilation (pale blue)

### To change a ventilation parameter



1. Select the **Ventilation Parameters** button (highlighted in pale blue for active or in yellow for a new form of ventilation).

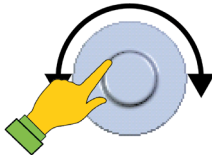

2. Set the parameter.  
3. Confirm the entry.



4. If a parameter was changed to a new form of ventilation, start this new form of ventilation with the changed ventilation parameter settings (yellow).

 If not confirmed, the form of ventilation presets are closed again after 45 seconds and the previous active parameters are retained.

### To switch to standby (stop ventilation)



1. Activate the **Standby** button on the keyboard.

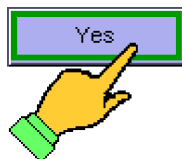

2. Confirm the screen dialogue on the touchscreen with **Yes**.

## Description of the forms of ventilation

### IMV

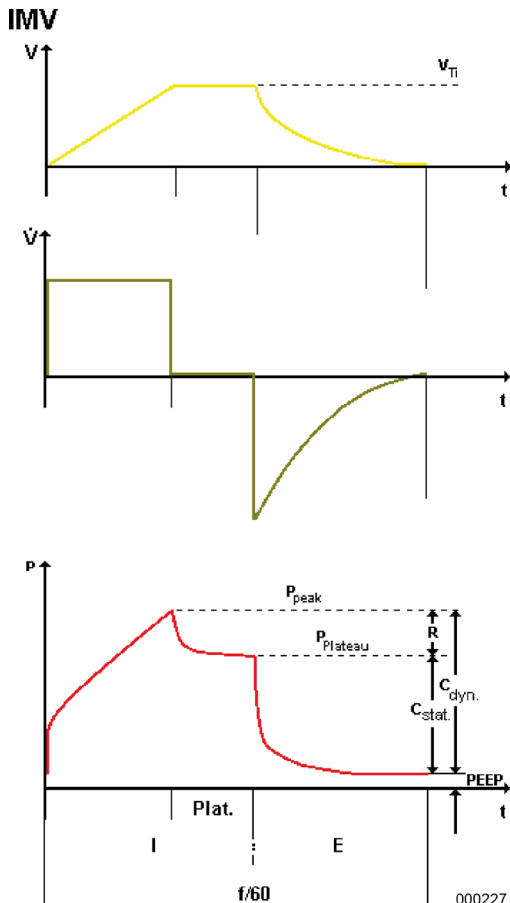

The IMV (intermittent mandatory ventilation) is a volume-controlled ventilation. A constant volume is sought.

In this form of ventilation, the respirator setting of the *leon plus* establishes the  $V_{Ti}$  breath volume and the I:E ratio timing and ventilation frequency. The setting of a PEEP and a plateau phase as a percentage share of the inspiration time is available.

If the pressure reaches the  $P_{Peak}$  alarm limit, the mechanical breath breaks off.

💡 If the alarm message " **$P_{max}$  reached too early**" appears, the  $V_{Ti}$  selected is so big that the ventilation pressure  $P_{aw}$  exceeds the set  $P_{max}$  limit. As the mechanical breath is not completely executed (in exceeding  $P_{ma}$  the plateau is developed) the set  $V_{Ti}$  and the MV resulting from it is not reached. This could possibly lead to volume alarms that cannot be fixed by increasing  $V_{Ti}$ , but through a raising of the  $P_{max}$  limit and/or the ventilation frequency and/or changing the I:E ratio.

$P_{Max}$   
50  
mbar

#### $P_{max}$ pressure limit in the IMV

In the IMV form of ventilation a maximum  $P_{max}$  limit can be set for safety. If this maximum desired  $P_{max}$  pressure limit is exceeded, the plateau phase is started too early and **the set tidal volume is not completely administered**. It then becomes a volume-controlled, pressure-limited form of ventilation.



Table 32: Setting parameters, setting range and increment of the IMV form of ventilation.

Ventilation parameters	Child		Adult	
	Range	Increment	Range	Increment
Fresh gas flow [l/min]	0.2-1	0.05	0.2-1	0.05
	1-18	0.1	1-18	0.1
Fresh gas O <sub>2</sub> [% from fresh gas flow]	25(21)-100	1	25(21)-100	1
V <sub>Ti</sub> [ml]	3-20 (optional)	1	300-1000	10
	20-50	2		
	50-100	5	1000-1600	50
	100-600	10		
V <sub>TG</sub> [ml] (optional)	/	/	/	/
P <sub>max</sub> [mbar]	10-80	1	10-80	1
P <sub>insp.</sub> [mbar]	/	/	/	/
Frequency [1/min]	14-80 (100)	1	4-40	1
I:E	1:4-4:1	0.1	1:4-4:1	0.1
T <sub>insp.</sub> [s]	/	/	/	/
PEEP [mbar]	OFF, 1-15	1	OFF, 1-20	1
Plateau [%]	OFF, 10-50	10	OFF, 10-50	10
Trigger [l/min]	/	/	/	/
Backup [s]	/	/	/	/

O<sub>2</sub> fresh gas parameters [% of fresh gas flow], minimal O<sub>2</sub> concentration fresh gas blender:

- with carrier gas AIR 21 %
- with carrier gas N<sub>2</sub>O 25 %

## PCV

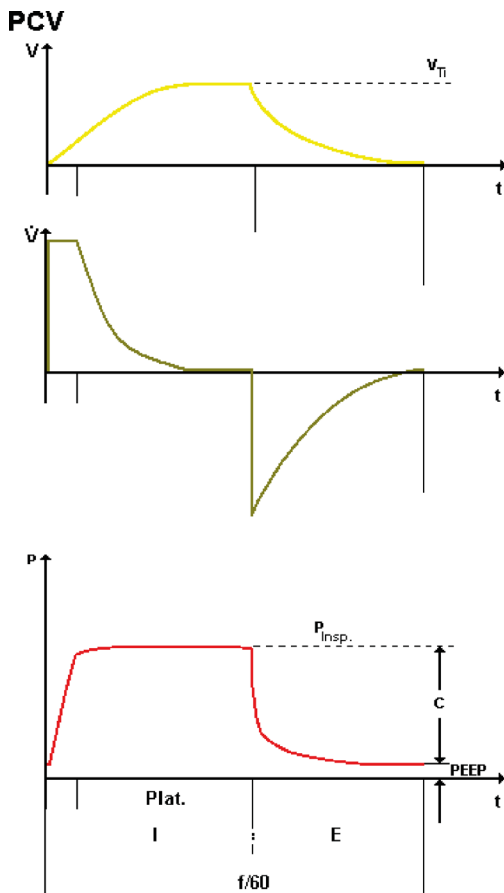

000228

PCV is **P**ressure **C**ontrolled **V**entilation. The aim is to achieve the set ventilation pressure.

In this form of ventilation, the respirator setting of the *leon plus* establishes the  $P_{insp}$ , ventilation pressure and the **I:E** ratio timing and ventilation **frequency**.

The setting of a **PEEP** and a **plateau** phase as a percentage share of the inspiration time is available.

The *leon plus* first ventilates the patient with a high, constant flow until the set  $P_{insp}$ , inspiration pressure is reached and then with a decelerated flow to keep the reached set ventilation pressure constant.

💡 *It is important to monitor the breath minute volume.*

💡 *Borderline settings occur if the inspiration time is too short to reach the desired  $P_{insp}$ , ventilation pressure.*

$P_{\text{Insp}}$ <b>14</b> mbar	$V_{\text{TG}}$ <b>Off</b> mL
--	-------------------------------------

$P_{\text{Max}}$ <b>21</b> mbar	$V_{\text{TG}}$ <b>500</b> mL
---------------------------------------	-------------------------------------

### Volume guarantee $V_{\text{TG}}$ in the PCV

In the PCV the ventilation parameter  $V_{\text{TG}}$  (Tidal volume guarantee) is available. At the start of the PCV,  $V_{\text{TG}}$  is OFF by default. If the  $V_{\text{TG}}$  is switched on, the ventilation parameter  $P_{\text{Insp}}$  changes to  $P_{\text{Max}}$ . The  $P_{\text{Max}}$  setting is set to  $P_{\text{Insp}}$ . Setting + 5 mbar.  $V_{\text{TG}}$  is allocated as the start value with the monitoring value  $V_{\text{TE}}$ .

After a  $V_{\text{TG}}$  is set as breath volume and a  $P_{\text{Max}}$  is corrected and confirmed as the pressure limit, this volume is administered to the patient under pressure control. If the maximum desired  $P_{\text{Max}}$  pressure limit is exceeded, the plateau phase is initiated prematurely and **the set tidal volume is not completely administered**

(→ "IMV" p. 162).

Therefore, this pressure-limited, pressure-regulated, tidal volume-guaranteed form of ventilation should not be deployed but the ventilation parameters should be adjusted so that a  $P_{\text{Max}}$  is not reached if possible.

If  $V_{\text{TG}}$  switched off, the ventilation parameter  $P_{\text{Max}}$  changes back to  $P_{\text{Insp}}$  and  $P_{\text{Insp}}$  is allocated as start value with the monitoring value  $P_{\text{Peak}}$ .

Table 33: Setting parameters, setting range and increment of the PCV form of ventilation

Ventilation parameters	Child		Adult	
	Range	Increment	Range	Increment
Fresh gas flow [l/min]	0.2-1	0.05	0.2-1	0.05
	1-18	0.1	1-18	0.1
Fresh gas O <sub>2</sub> [% from fresh gas flow]	25(21) - 100	1	25(21) - 100	1
V <sub>Ti</sub> [ml]	/	/	/	/
V <sub>TG</sub> [ml] (optional)	OFF, 3-20	1	OFF, 300-1000	10
	20-50	2		
	50-100	5	1000-1600	50
	100-600	10		
P <sub>max</sub> [mbar]	5-60	1	5-60	1
P <sub>insp.</sub> [mbar]	5-60	1	5-60	1
Frequency [1/min]	14-80 (100)	1	4-40	1
I:E	1:4-4:1	0.1	1:4-4:1	0.1
T <sub>insp.</sub> [s]	/	/	/	/
PEEP [mbar]	OFF, 1-15	1	OFF, 1-20	1
Plateau [%]	10-90	5	10-90	5
Trigger [l/min]	/	/	/	/
Backup [s]	/	/	/	/

O<sub>2</sub> fresh gas parameters [% of fresh gas flow], minimal O<sub>2</sub> concentration fresh gas blender:

- with carrier gas AIR 21 %
- with carrier gas N<sub>2</sub>O 25 %

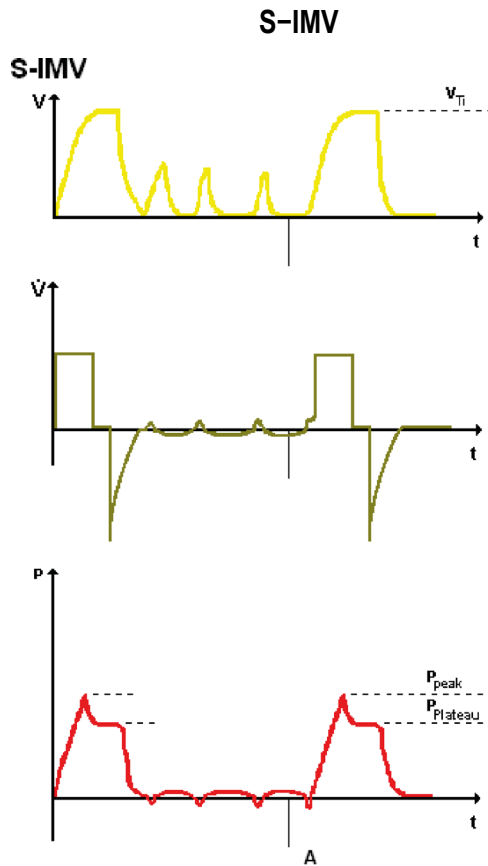

In S-IMV (**S**ynchronized **I**ntermittent **M**andatory **V**entilation) mechanical breaths are combined with spontaneous breathing. The patient can breathe at his/her own respiratory rhythm and nevertheless receive a preset number of mechanical breaths dependent of the set ventilation **frequency**, which are synchronised by the *leon plus* after triggering by the patient.

With the **S-IMV** the mechanical breath is administered via volume-controlled  $V_{Ti}$ . The setting of the  $T_{insp.}$  inspiration time of a **PEEP** and a **plateau** phase as a percentage share of the inspiration time is available.

When the time has come for the mechanical breath according to the set frequency, a "**trigger**" is activated by the *leon plus* (the patient can release the trigger). The next inspiration effort by the patient leads to administration of the mechanical breath. The time from half of the entire breath period ( $T_{insp.} + T_{exp.}$ ) until the end of the expiration time (but at least 500 ms after the start of the inspiration time) that is available for the trigger activation is called a "breath-by-breath" window. If the trigger was not activated by the end of this breath-by-breath window, the breath is administered unsynchronised. Finally, a period follows with the option of spontaneous breathing until the start of the next "breath-by-breath" window.

000230

- 💡 *It must be ensured that adequate volume monitoring takes place.*
- 💡 *With this form of ventilation the duration of the controlled phases is fixed, i.e. an expiration of the patient during the mechanical breath is not possible. This can lead to pressure increases if the patient makes expiration attempts, which are, however, limited by the  $P_{Peak}$  alarm*

Table 34: Setting parameters, setting range and increment of the S-IMV form of ventilation.

Ventilation parameters	Child		Adult	
	Range	Increment	Range	Increment
Fresh gas flow [l/min]	0.2-1	0.05	0.2-1	0.05
	1-18	0.1	1-18	0.1
Fresh gas O <sub>2</sub> [% from fresh gas flow]	25(21)-100	1	25(21)-100	1
V <sub>Ti</sub> [ml]	3-20 (optional)	1	300-1000	10
	20-50	2		
	50-100	5	1000-1600	50
	100-600	10		
V <sub>TG</sub> [ml] (optional)	/	/	/	/
P <sub>max</sub> [mbar]	10-80	1	10-80	1
P <sub>insp.</sub> [mbar]	/	/	/	/
Frequency [1/min]	6-60	1	4-40	1
I:E	/	/	/	/
T <sub>insp.</sub> [s]	0.2-2.9	0.1	0.3-10	0.1
PEEP [mbar]	OFF, 1-15	1	OFF, 1-20	1
Plateau [%]	OFF, 10-50	10	OFF, 10-50	10
Trigger [l/min]	0.1-0.5	0.1	0.1-0.5	0.1
	0.6-5	0.5	0.6-5	0.5
	6-10	1	6-10	1
Backup [s]	/	/	/	/

O<sub>2</sub> fresh gas parameters [% of fresh gas flow], minimal O<sub>2</sub> concentration fresh gas blender:

- with carrier gas AIR 21 %
- with carrier gas N<sub>2</sub>O 25 %

## S-PCV

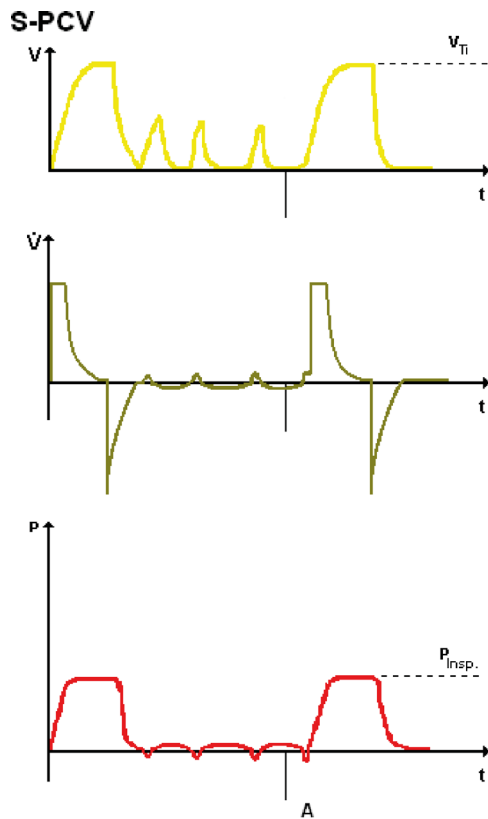

000231

In S-PCV (**S**ynchronized **P**ressure **C**ontrolled **V**entilation) mechanically controlled mechanical breaths are combined with spontaneous breathing. The patient can breathe at his/her own respiratory rhythm and nevertheless receive a preset number of mechanical breaths dependent of the set ventilation **frequency**, which are synchronised by the *leon plus* after triggering by the patient.

With the **S-PCV** the mechanical breath is administered via pressure-controlled  $P_{\text{insp}}$ . The setting of the  $T_{\text{insp}}$ , inspiration time of a **PEEP** and a **plateau** phase as a percentage share of the inspiration time is available.

When the time has come for the mechanical breath according to the set frequency, a "**Trigger**" is activated by the *leon plus* (the patient can release the trigger). The next inspiration effort by the patient leads to administration of the mechanical breath. The time from half of the entire breath period ( $T_{\text{insp.}} + T_{\text{exp.}}$ ) until the end of the expiration time (but at least 500 ms after the start of the inspiration time) that is available for the trigger activation is called a "breath-by-breath" window. If the trigger was not activated by the end of this breath-by-breath window, the breath is administered unsynchronised. Finally, a period follows with the option of spontaneous breathing until the start of the next "breath-by-breath" window.

- 💡 *It must be ensured that adequate volume monitoring takes place.*
- 💡 *With this form of ventilation the duration of the controlled phases is fixed, i.e. an expiration of the patient during the mechanical breath is not possible. This can lead to pressure increases if the patient attempts expiry, which are, however, limited by the  $P_{\text{Peak}}$  alarm.*

Table 35: Setting parameters, setting range and increment of the S-PCV form of ventilation.

Ventilation parameters	Child		Adult	
	Range	Increment	Range	Increment
Fresh gas flow [l/min]	0.2-1	0.05	0.2-1	0.05
	1-18	0.1	1-18	0.1
Fresh gas O <sub>2</sub> [% from fresh gas flow]	25(21)-100	1	25(21)-100	1
V <sub>Ti</sub> [ml]	/	/	/	/
V <sub>TG</sub> [ml] (optional)	/	/	/	/
P <sub>max</sub> [mbar]	/	/	/	/
P <sub>insp.</sub> [mbar]	5-60	1	5-60	1
Frequency [1/min]	6-60	1	4-40	1
I:E	/	/	/	/
T <sub>insp.</sub> [s]	0.2-2.9	0.1	0.3-10	0.1
PEEP [mbar]	OFF, 1-15	1	OFF, 1-20	1
Plateau [%]	10-90	5	10-90	5
Trigger [l/min]	0.1-0.5	0.1	0.1-0.5	0.1
	0.6-5	0.5	0.6-5	0.5
	6-10	1	6-10	1
Backup [s]	/	/	/	/

O<sub>2</sub> fresh gas parameters [% of fresh gas flow], minimal O<sub>2</sub> concentration fresh gas blender:

- with carrier gas AIR 21 %
- with carrier gas N<sub>2</sub>O 25 %



## PSV

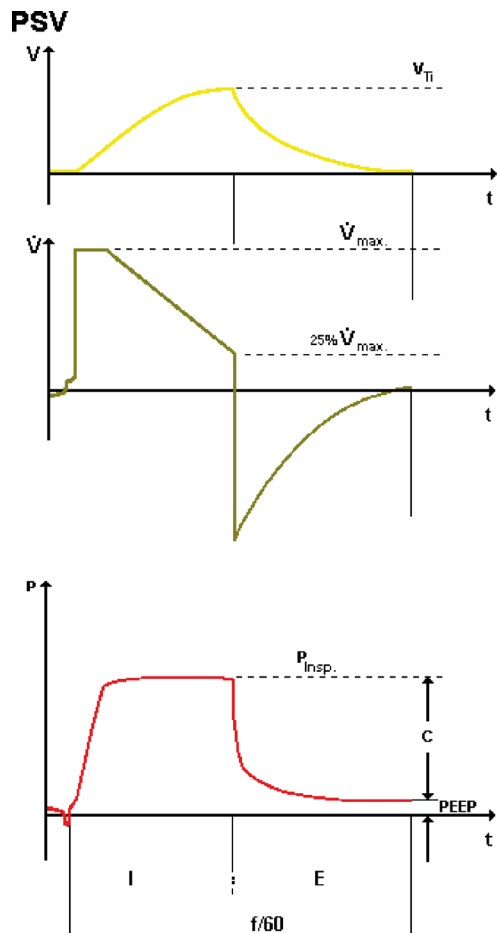

The PSV (**P**ressure **S**upport **V**entilation) serves as pressure support of insufficient spontaneous breathing. The breath frequency is determined by the patient, while the *leon plus* takes over an adjustable share of the ventilation work. Each spontaneous inspiration attempt is supported with the aid of technical equipment (adjustable **trigger**) by an adjustable positive  $P_{insp}$  pressure. While the patient triggers the inspiration, the *leon plus* starts the expiration if the inspiration flow has dropped 25% of the previously reached maximum value.

The setting of a **PEEP** is possible.

If the *leon plus* is not triggered by an adjustable apnoea time (backup) of the patient, the *leon plus* starts an inspiration independently.

In addition, a **manual breath** can be started by means of a button not activated by the patient.

💡 *If an inspiration time of 4 s is exceeded, the *leon plus* starts the expiration independently.*

000229

Table 36: Setting parameters, setting range and increment of the PSV form of ventilation.

Ventilation parameters	Child		Adult	
	Range	Increment	Range	Increment
Fresh gas flow [l/min]	0.2-1	0.05	0.2-1	0.05
	1-18	0.1	1-18	0.1
Fresh gas O <sub>2</sub> [% from fresh gas flow]	25(21)-100	1	25(21)-100	1
V <sub>Ti</sub> [ml]	/	/	/	/
V <sub>TG</sub> [ml] (optional)	/	/	/	/
P <sub>max</sub> [mbar]	/	/	/	/
P <sub>insp.</sub> [mbar]	5-60	1	5-60	1
Frequency [1/min]	/	/	/	/
I:E	/	/	/	/
T <sub>insp.</sub> [s]	/	/	/	/
PEEP [mbar]	OFF, 1-15	1	OFF, 1-20	1
Plateau [%]	/	/	/	/
Trigger [l/min]	0.1-0.5	0.1	0.1-0.5	0.1
	0.6-5	0.5	0.6-5	0.5
	6-10	1	6-10	1
Backup [s]	4-10	2	4-10	2
	10-15	5	10-15	5
	15-45	15	15-45	15

O<sub>2</sub> fresh gas parameters [% of fresh gas flow], minimal O<sub>2</sub> concentration fresh gas blender:

- with carrier gas AIR 21 %
- with carrier gas N<sub>2</sub>O 25 %

### Locked ventilation parameters

#### Display of a lock

If the setting of a ventilation parameter is not possible due to its lock, this is symbolised by an arrow on the button of the ventilation parameter that is preventing the setting. To release the lock, the ventilation parameter concerned must be changed to "arrow direction".

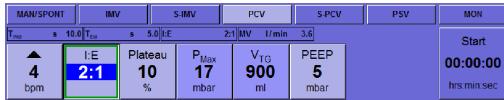

#### Display of a lock through too-low frequency

To increase the I share of a 2:1 I:E ratio, the ventilation frequency must first be raised.

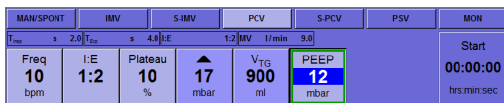

#### Display of a lock by too-high PEEP compared with P<sub>insp.</sub> in the PCV

To achieve in the PCV a PRRP greater than 11 with a set P<sub>insp.</sub> inspiration pressure of 16, the P<sub>insp.</sub> must first of all be increased.

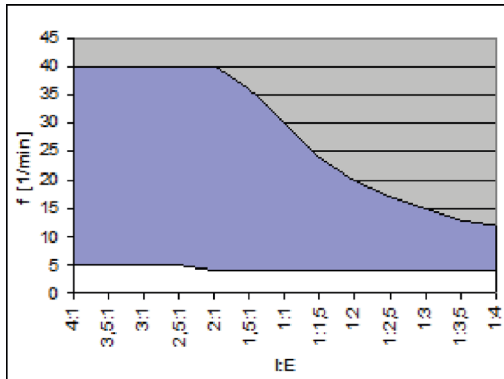

Maximum ventilation frequency with a given I:E ratio (adult)

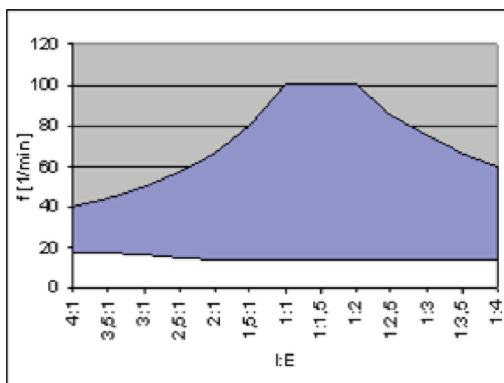

Maximum ventilation frequency with a given I:E ratio (child)

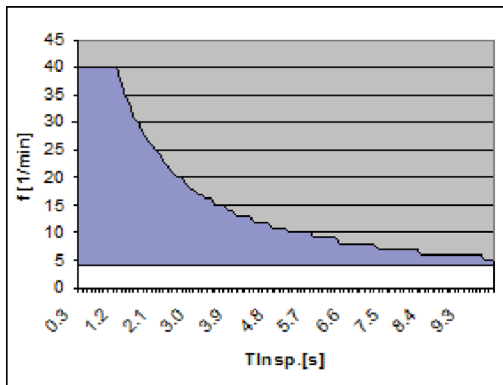

Maximum ventilation frequency with a given  $T_{\text{insp}}$ .  
(Adult)

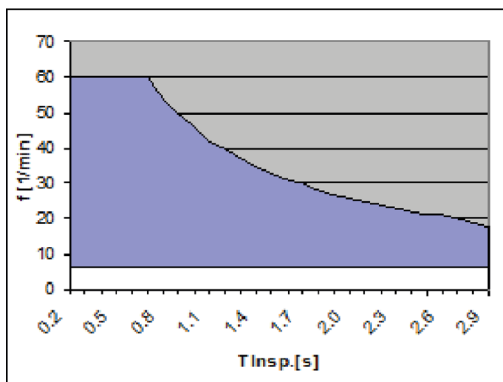

Maximum ventilation frequency with a given  $T_{\text{insp}}$ .  
(child).

### Takeover of ventilation parameters

- 💡 When switching from a pressure-controlled ventilation to a volume-controlled ventilation, the reached volume is taken over as a preset for  $V_{T_i}$ .
- 💡 When switching from a volume-controlled ventilation to a pressure-controlled ventilation,  $P_{\text{Plat.}}$  is taken over as a pre-set for  $P_{\text{ins.}}$
- 💡 The plateau setting is not taken over from a volume-controlled ventilation to a pressure-controlled ventilation and vice versa.
- 💡 No parameters are taken over or transferred in and out of the PSV and HLM forms of ventilation.
- 💡 Other parameters are taken over only if they are available and valid as settings in the new form of ventilation.

## 9. Monitoring

### General information

All measured values are administered for BTPS. Flow, pressure and concentrations are measured by sensors. All other sizes are derived from these measured values.

**Data**

The following data are displayed on the screen for monitoring:



000063

- |  |   |
|--|---|
| <p>(1) tabs</p> <p>(2) alarm muting</p> <p>(3) batteries</p> <p>(4) calculated values I</p> <ul style="list-style-type: none"> <li>- Leak</li> <li>- %Spont.</li> <li>- MAC</li> <li>- Compliance (static<sup>1</sup>, dynamic)</li> <li>- C20/C<sup>1</sup></li> <li>- Resistance<sup>1</sup></li> </ul> <p>(5) measured values</p> <ul style="list-style-type: none"> <li>- values as a graphical display (real-time, trend)</li> <li>- values as a numerical display (monitoring, tabular)</li> </ul> | <p>(6) calculated values II</p> <ul style="list-style-type: none"> <li>- T<sub>insp.</sub></li> <li>- T<sub>exp.</sub></li> <li>- I:E</li> <li>- MV</li> </ul> <p>(7) Gas concentration</p> <ul style="list-style-type: none"> <li>- Values as graphical display</li> <li>- Values as numerical display</li> </ul> <p>(8) Pressures</p> <ul style="list-style-type: none"> <li>- CGS</li> <li>- 10 L bottles</li> </ul> <p>(9) Bar graphs</p> <ul style="list-style-type: none"> <li>- Fresh gas amount (O<sub>2</sub>, N<sub>2</sub>O, AIR)</li> </ul> |
|--|---|

<sup>1</sup>) Is only displayed with an existing plateau.

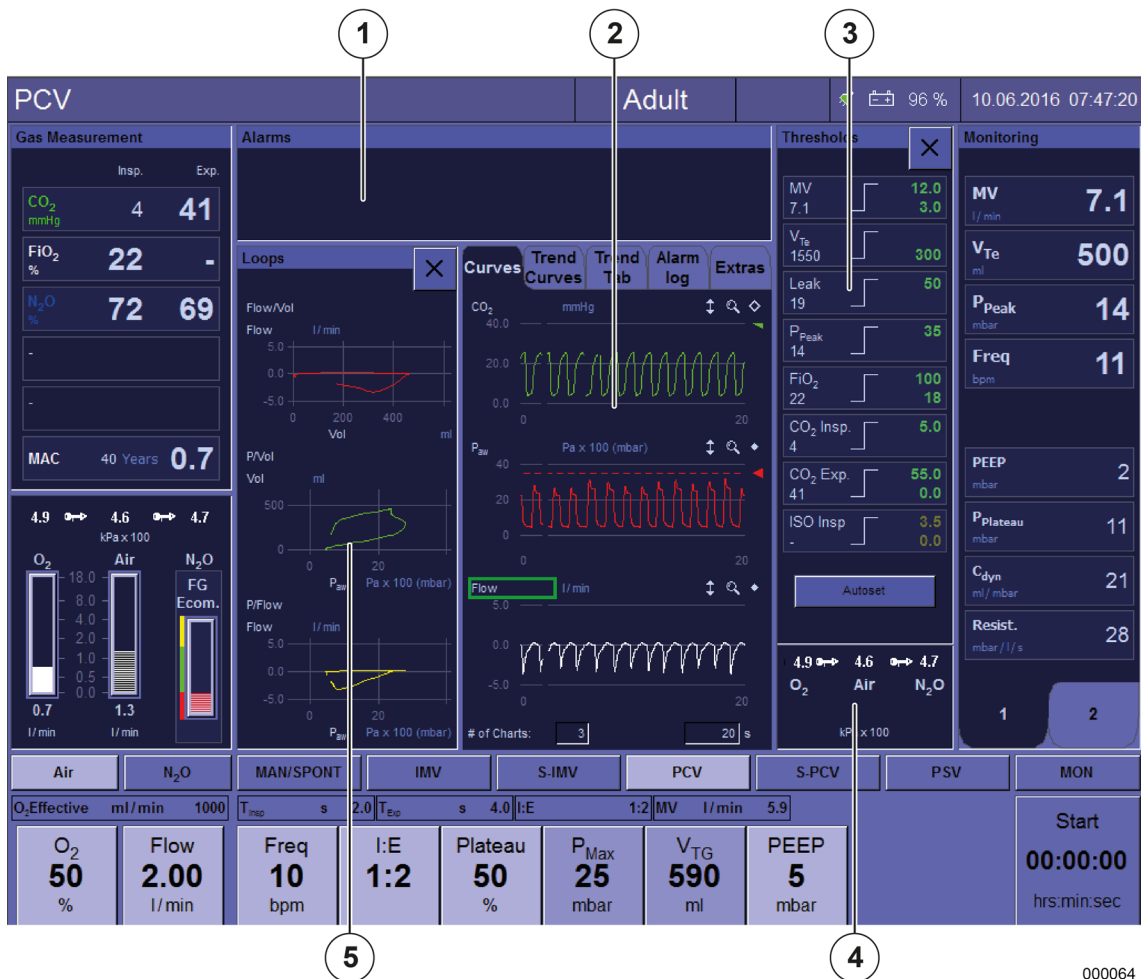

000064

- (1) alarm messages
- (2) real-time graphs
- (3) limit values
- (4) supply pressures
  - CGS
  - 10 L bottles

- (5) Loops
  - Volume over pressure
  - Flow over pressure
  - Flow over volume

## **Alarm muting (mute)**

---

(→ *"Alarm muting" p. 204*)

## **Limit values**

---

(→ *"Limit values (patient alarm limits)" p. 207*)

## **Alarm messages**

---

(→ *"List of alarm messages" p. 214*)

## **Batteries**

---

(→ *"Batteries" p. 199*)

## **Device functions**

---

(→ *"Monitoring of device functions" p. 192*)



Monitored data

Measured values as graphical display

Data as real-time curves



The following measured values for monitoring are displayed as curves (a minimum of one or maximum 4 measured values can be displayed as curve(s)):

- Airway pressure [mbar]
- Flow [l/min]
- Volume (inspiratory) [ml]
- patient gases
  - O<sub>2</sub> [%]
  - CO<sub>2</sub> [%, mmHg, hPa, kPa]
  - N<sub>2</sub>O [%]
  - volatile anaesthetics
    - halothane [%]
    - enflurane [%]
    - isoflurane [%]
    - sevoflurane [%]
    - desflurane [%]

1. Select the **Curves** tab.



2. Select the button in the window.

(→ "Table 12: Icons/screen (control elements)" p. 44)



3. Set the parameters.

4. Confirm the entry.

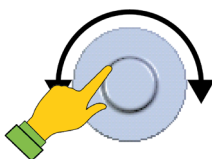

## Data as trend curves

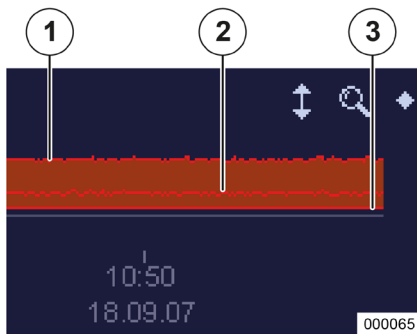

The following measured values for monitoring are displayed as trend curves (a minimum of one or maximum 4 measured values can be displayed as a bar chart). The values are stored every five seconds:

airway pressures [mbar]

minute volume [ml]

frequency

patient gases

- O<sub>2</sub> [%]/FiO<sub>2</sub> [%]
- CO<sub>2</sub> [%, mmHg, hPa, kPa]
- N<sub>2</sub>O [%]
- volatile anaesthetics
  - halothane [%]
  - enflurane [%]
  - isoflurane [%]
  - sevoflurane [%]
  - desflurane [%]

Calculated values I

- MAC
- Compliance
  - static<sup>1</sup> [ml/mbar]
  - dynamic [ml/mbar]
- Resistance<sup>1</sup> [mbar/l/s]

(1) P<sub>Peak</sub>

(2) P<sub>Mean</sub>

(3) PEEP

<sup>1</sup>) Is only displayed with an existing plateau.

1. Select the **Trend Curve** tab.
2. Select the button in the window.  
(→ "Table 12: Icons/screen (control elements)" p. 44)
3. Set the parameters.
4. Confirm the entry.

**Trend curve display bigger for expiratory values than inspiratory values**

💡 Under certain conditions (e.g. anaesthetics drainage) expiratory gas values can be bigger than inspiratory values. To mark this trend, the expiratory side of the bar chart is marked with a line in a different colour.

(1) Expiration value

Table 37: Resolution and autoscaling range of the real-timecurves

Real-time curves	Range max.	Resolution max.	Autoscaling	
			Lower limit	Upper limit
P <sub>aw</sub> [mbar]	-10 – +100	5	-5	Alarm P <sub>peak</sub> + 5
Flow [l/min]	-200 – +200	5	0	Flow max. × 1,25
Volume [ml]	0 – + 2000	10	0	V <sub>Te</sub> max. × 1,25
O <sub>2</sub> [%]	0 – +100	5	15	insp. O <sub>2</sub> alarm high
CO <sub>2</sub> [%]	0 – +10	0.5	0	exp. O <sub>2</sub> alarm high
volatile anaesthetics [%] (except for desflurane)	0 – +10	0.1	0	insp. volatile anaesthetics high
DES [%]	0 – +22	1	0	insp. DES alarm high
N <sub>2</sub> O [%]	0 – +100	1	0	Concentration in the FG

CO<sub>2</sub> curve value setting: autoscaling=OFF, X-axis range=0–40 mmHg

## Tabular trend

Curves		Trend Curves		Trend Tab		Alarm log		Extras	
Datum/Zeit	Event	e(CO2	O2 In/ex	AGT In/ex	MAC	Ppeak/PEEP	MV		
28.08.2007 14:15		5.7	38/33	8.0/5.5	3.3	15/2	7.1		
28.08.2007 14:10		5.7	39/35	8.3/5.4	3.2	15/2	7.1		
28.08.2007 14:05		6.0	38/37	8.5/5.6	3.2	15/2	7.1		
28.08.2007 14:00		5.5	37/33	7.7/5.3	3.1	15/2	7.1		
28.08.2007 13:56	PCV								
28.08.2007 13:55	Sevo.								
28.08.2007 13:55	Bereit								
28.08.2007 13:21	Stop								
28.08.2007 13:19	Bereit								
28.08.2007 13:15			38/33	7.9/5.4	3.2	15/2	7.1		
28.08.2007 13:11	PCV								
28.08.2007 13:03	Sevo.								
28.08.2007 13:03	Enf.								
28.08.2007 13:03	Iso.								
28.08.2007 13:03	Sevo.								
28.08.2007 13:02	Des.								
28.08.2007 12:21	Hal								
28.08.2007 12:21	Bereit								

000193

Up to 12 values, as desired (configurable), updated every five seconds, can be displayed as a table:

- Date
- Time
- Event
  - start and stop of a ventilation
  - change of anaesthetic gas
- Measured values
  - insp./exp. CO<sub>2</sub> [%, mmHg, hPa, kPa]
  - insp./exp. O<sub>2</sub> [%] /FiO<sub>2</sub> [%]
  - insp./exp. N<sub>2</sub>O [%]
  - insp./exp. agent [%]
  - P<sub>Peak</sub>/PEEP [mbar]
  - P<sub>Mean</sub> [mbar]
  - MV [l/min]
  - Freq [1/min]
- Calculated values I
  - MAC
  - static<sup>1</sup>/dynamic compliance [ml/mbar]
  - Resistance [mbar/l/s]<sup>1</sup>

<sup>1</sup>) Is only displayed with an existing plateau.

## Event log

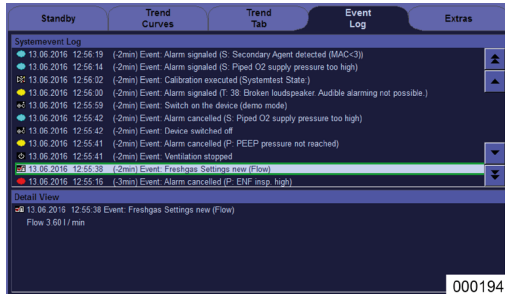

All of the settings made, occurring alarms and events on the leon *plus* are displayed in the event log. Events can be displayed in a detailed view:

- display
    - coding
    - date
    - time
    - time difference to current time
    - event
  - coding
    - alarms
- (→ "Alarm priorities" p. 201)
- events

### Possible events



Turning device on/off



Start/stop of a ventilation



Change of form of ventilation



Change of ventilation parameters



Change of alarm limits



Fresh gas, carrier gas changes (only for the leon *plus*)



Calibrations



The event log can only be viewed in standby.

## Measured values in a numerical display

### Monitoring ventilation measured values and calculated values I

Monitoring	
MV l/min	7.1
V <sub>Te</sub> ml	500
P <sub>Peak</sub> mbar	14
P <sub>plateau</sub> mbar	11
PEEP mbar	0
C <sub>stat</sub> ml/mbar	16
P <sub>mean</sub> mbar	5
Freq <sub>CO2</sub> bpm	18
1	2

Monitoring	
MV l/min	7.1
V <sub>Te</sub> ml	500
P <sub>Peak</sub> mbar	15
P <sub>plateau</sub> mbar	12
PEEP mbar	0
Leak %	20
C20/C	1.1
Resist. mbar/l/s	32
1	2

The following measured values of the ventilation are displayed for monitoring:

- pressures
  - peak pressure P<sub>Peak</sub> [mbar]
  - medium pressure P<sub>Mean</sub> [mbar]
  - plateau pressure P<sub>Plateau</sub> [mbar]
  - PEEP [mbar]
  - CPAP [mbar]
- Volumine
  - exp. MV breath minute volume [l/min]
  - insp. V<sub>Ti</sub> breath volume [ml]
  - exp. V<sub>Te</sub> breath volume [ml]
- frequencies
  - ventilation frequency Freq. [1/min]
  - breathing rate via CO<sub>2</sub> Freq.<sub>CO2</sub> [1/min]
  - breathing rate spontaneous Freq.<sub>Spont.</sub> [1/min]
  - share of spontaneous breaths %Spont. [%]
  - inspiration time of spontaneous breaths T<sub>i</sub> Spont. [s]
- calculated values I
  - leak [%]
  - MAC
  - Compliance (static [mbar/ml]<sup>1</sup>, dynamic [mbar/ml])
  - C20/C<sup>1</sup>
  - Resistance [mbar/l/s]<sup>1</sup>

<sup>1)</sup> Is only displayed with an existing plateau.

8 values are displayed on each of two pages, if desired (configurable). 4 values in the upper section of the monitoring window are displayed larger. This is where the important measured values should be positioned. These 4 measured values are the same on both pages.

 *In MAN/SPONT the monitoring values after elapse of the apnoea time switch to --.-.*

**Control element Monitoring ventilation and calculated values I**

1. Focus the window.
2. Select the measured value in the window.
3. Change the value.
4. Confirm the entry.
5. Call up the measured values on page 1 or 2.

 *The monitoring window can only be selected via the touchscreen.*

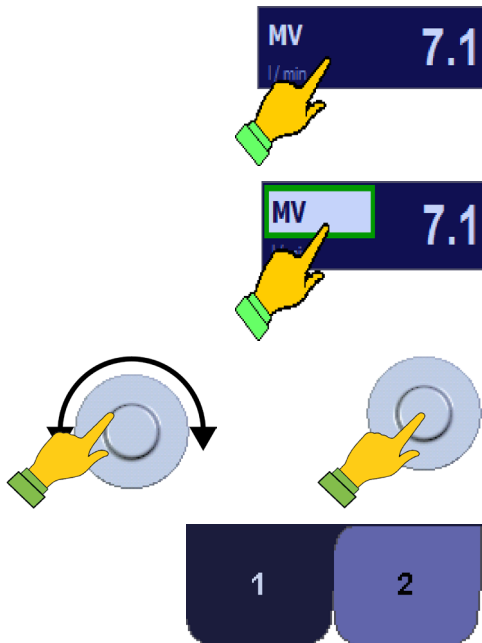

Table 38: Range and resolution of the numerically displayed measured values

Measured value		Range	Resolution
MV [l/min]		0-50	0.1
V <sub>Ti</sub> [ml] and V <sub>Te</sub> [ml]	Adult, IBW	0-1000	10
		1000-5000	50
	Child	0-100	1
		100-5000	10
P <sub>peak</sub> [mbar]		-50-200	1
P <sub>plateau</sub> [mbar]		-50-200	1
P <sub>mean</sub> [mbar]		-50-200	1
PEEP [mbar]		-50-200	1
CPAP [mbar]		-50-200	1
Freq. [1/min]		0-300	1
Freq. <sub>Spont.</sub> [1/min]		0-300	1
Freq. <sub>CO2</sub> [1/min]		0-100	1
T <sub>i</sub> Spont [s]		0-10	0.1
MAC		0-10	0.1
Compl. stat. [ml/mbar]		0-1000	1
Compl. dyn. [ml/mbar]		0-1000	1
C20/C		0-200	1
Resist. [mbar/l/s]		0-1000	1
%Spont. [%]		0-100	1
Leak [%]		10-100	1



### monitoring:calculated values II

The following ventilation values that are calculated via the settings are displayed:

O <sub>2</sub> Effective		ml/min	3000
T <sub>insp</sub>	s	2.0	T <sub>exp</sub>
s	4.0	I:E	1:2

MV	l/min	1.2
----	-------	-----

- Blender
  - O<sub>2</sub> effective [ml/min] o. [l/min]
- I:E ratio
  - T<sub>insp.</sub> [s]
  - T<sub>exp.</sub> [s]
  - I:E
- Volume
  - MV (**only if V<sub>TI</sub> or V<sub>TG</sub> can be adjusted as a setting**)



O<sub>2</sub> effective is the amount of 100% oxygen in the set fresh gas.

### Gas measurement

Gas Measurement		
	Insp.	Exp.
CO <sub>2</sub> mmHg	5	40
FiO <sub>2</sub> %	22	-
N <sub>2</sub> O %	66	68
Hal. %	8.8	1.0
Enf. %	-	0.5
MAC	40 Years	2.3

100462

The following inspiratory and expiratory gas measurement values are displayed for monitoring:

- CO<sub>2</sub>
- O<sub>2</sub> or FiO<sub>2</sub>
- N<sub>2</sub>O
- Volatile anaesthetics
  - halothane
  - enflurane
  - isoflurane
  - sevoflurane
  - desflurane

The measurement of O<sub>2</sub>, N<sub>2</sub>O and volatile anaesthetics is optional.

Volatile anaesthetics (inspiratory and expiratory) can be optionally detected and displayed automatically from a concentration of 0.15% (auto ID automatic anaesthesia gas measurement.)

The multi-gas analyser calibrates automatically at regular intervals. More frequently during the first 10 minutes after start, then only about every 4 hours.

Calibration is indicated as follows:

- Info alarm: “Calibrating multi-gas analyser”
- numerical gas measurement values are issued as “-”
- the real-time charts of the gas concentrations continue to run constantly at the last displayed value until the end of the calibration phase

💡 *In the gas measurement window the age for the MAC value calculation is given.*

Anaesthesia gases are colour-coded:

- halothane: red
- enflurane: orange
- isoflurane: purple
- sevoflurane: yellow
- desflurane: blue

💡 *The detection of a second narcotic gas only happens if the gas measurements is equipped with an automatic narcotic gas identification.*

💡 *It is possible that the gas measurement displays wrong measured values for halothane, even though it is not deployed as a volatile anaesthetic. This phenomenon appears with greater frequency during low-flow anaesthesia. Methane is produced through microbial fermentation of carbohydrates and is expelled from the body via the lungs. Methane absorbs at the same wavelength as halothane and thus has an influence on the determination of the halothane concentration.*

💡 *The deployment of alcohol-containing cleaning products can also falsify the measurement.*

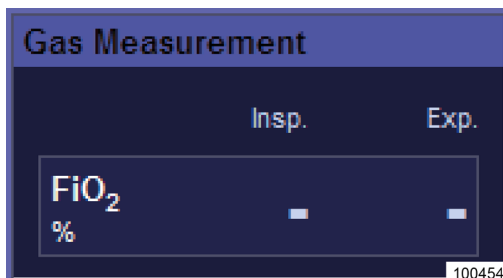

**Gas measurement window only with FiO<sub>2</sub> measurement**

Only inspiratory FiO<sub>2</sub> is displayed for monitoring.

## Entry of age for MAC calculation

Gas Measurement		
	Insp.	Exp.
CO <sub>2</sub> mmHg	5	40
FiO <sub>2</sub> %	22	-
N <sub>2</sub> O	66	68
Hal.	8.8	1.0
Enf. %	-	0.5
MAC	40 Years	2.3

100455

The display of the MAC value and the age entry to be calculated take place in the gas measurement window.

1. Focus the **gas measurement** window.

MAC	39 Years	0.7
-----	----------	-----

000203

2. Select the **MAC** field in the window.

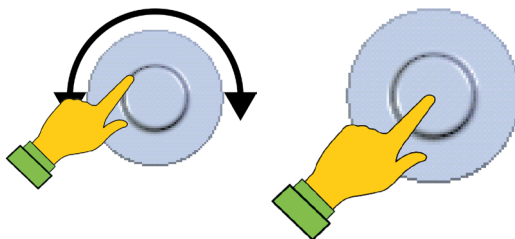

3. Change the value.
4. Confirm the entry.

## Manual selection of the narcotic gas

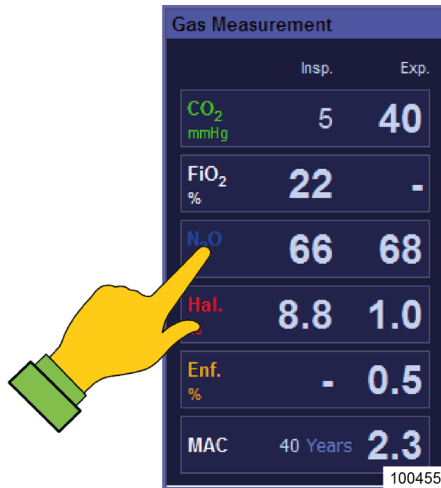

If the multi gas analyser is not equipped with an automatic anaesthetic gas identification, the selection is carried out via the gas measurement window. The adjacent dialogue opens by touching the field in which the anaesthetic gas concentration is displayed. The last anaesthetic gas set is displayed in the gas measurement window by default.

1. Focus the **gas measurement** window (field anaesthetic gas concentration display).

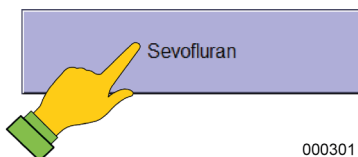

2. Select the anaesthetic gas button in the window.

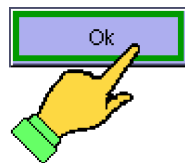

3. Confirm the entry with the **OK** button.



### CAUTION

Wrong selection of anaesthetic gas!

#### Death or permanent injury of the patient

Through wrong manual selection, the anaesthetic gas concentration is no longer correct.

- Be sure to make the precisely correct selection!

## Detection of triggered breaths



In the S-IMV, S-PCV and PSV forms of ventilation, in which the patient can trigger a mechanical breath, the moment of triggering can be marked by a vertical line in the real-time charts in the relevant chart colour.

## Loops (monitoring of lung function)

### Three loops window

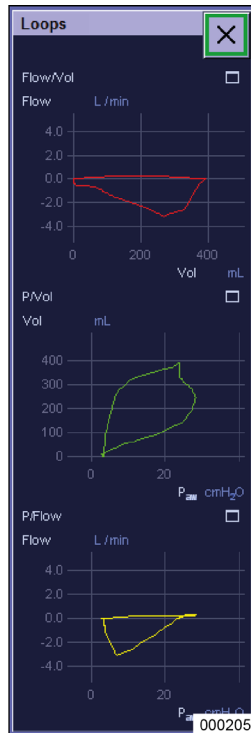

To monitor the lung function, three loops can be displayed at the same time:

- Flow over volume
- Volume over pressure
- Flow over pressure



With this button, you can open or close the window with three loops, or close the full screen with one loop.



With this button, you can open one of the three loop windows in full screen.

 *The window with three loops must be open to see the loop window in full screen.*



With this button, you can close the full screen window or the window with three loops.

 *Other operating elements:*  
 (→ "Table 12: Icons/screen (control elements)" p. 44)  
 (→ "Table 13: Icons/screen (buttons)" p. 44)

10. Monitoring of device functions

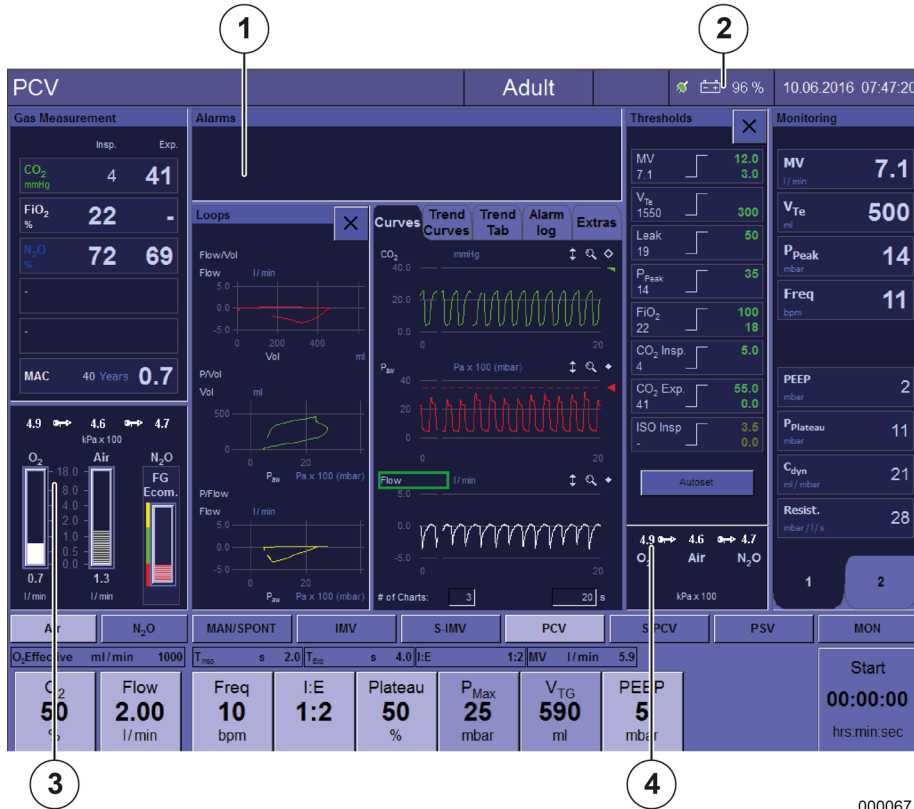

000067

The following functions are displayed on the screen for monitoring:

- fresh gas blender
- batteries
- drive gas supply
- gas supply pressures
- supply pressures 10 L bottles
- reserve gas bottle operation (only as alarm message)
- drive gas generator (only as alarm message)
- gas measurement (only as alarm message)
- fresh gas shortage (only as alarm message)
- patient module (only as alarm message)
- CO<sub>2</sub> absorber (only as alarm message)
- fans (only as alarm message)

- (1) alarm messages
- (2) batteries
- (3) fresh gas blender
- (4) gas supply pressures
- (→ "Errors and measures" p. 233)

## Fresh gas blender

### Intact fresh gas blender

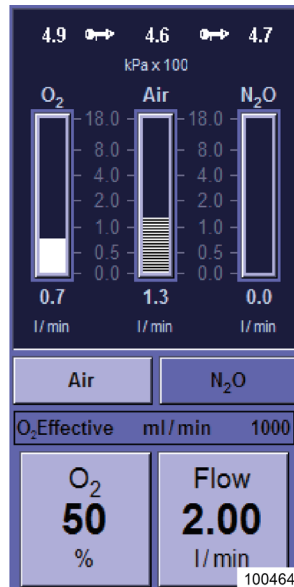

With an intact fresh gas blender there is a graphic display within the tube of the flowing O<sub>2</sub>, AIR and N<sub>2</sub>O amounts.

The following buttons are active:

- Selection of carrier gas
- Setting of the percentage share of oxygen on the fresh gas flow
- Fresh gas flow

💡 *The inlet pressures of the gases for the fresh gas blender must be at least 1.1 kPa × 100 (bar). Otherwise, the gas is deactivated.*

### Fresh gas blender in the event of failure of a carrier gas

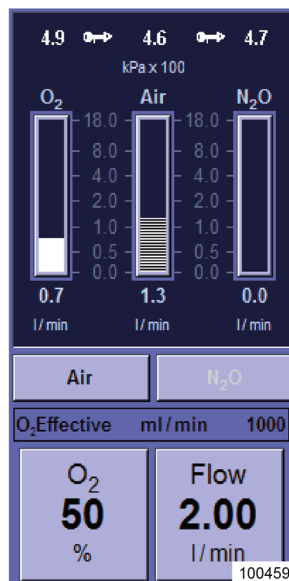

The button for the selection of the failed gas (N<sub>2</sub>O here) as carrier gas is greyed out. The gas must no longer be used as a carrier gas. In the event of CGS failure, N<sub>2</sub>O and O<sub>2</sub> can be made available via reserve gas bottles. If AIR fails, O<sub>2</sub> is used as carrier gas.

💡 *Requirement for reserve gas bottle operation:*

- Reserve gas bottles available
- Reserve gas bottles sufficiently filled
- Reserve gas bottles opened

### Display of damaged fresh gas blender

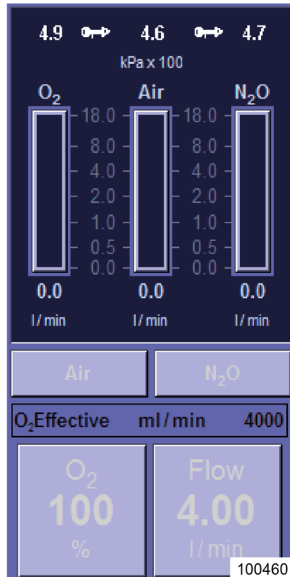

If the blender fails, the buttons for the selection of AIR or N<sub>2</sub>O as carrier gas, the button to set the flow and the button to set the percentage O<sub>2</sub> share in the fresh gas are greyed out. AIR and N<sub>2</sub>O must no longer be used as carrier gases.

- the buttons to set the percentage share of O<sub>2</sub> in the fresh gas flow and the fresh gas flow are inactive
- the fresh gas flow to the system, consists of 100% O<sub>2</sub>, can only be regulated via O<sub>2</sub> emergency dosing

💡 *If the blender fails: Set the O<sub>2</sub> emergency dosing to the desired fresh gas flow. Check the anaesthetic vaporiser setting, as the fresh gas flow has changed*

💡 *The button on the keyboard for focusing the fresh gas blender window is inactive.*

### Gas supply pressures



The gas supply pressures are displayed in the lower section of the **Threshold** window. In addition, there is a display in the fresh gas blender window.

(→ "Fresh gas blender" p. 193)



You can open the **Threshold** window with this button.



You can close the **Threshold** window with both of these buttons.



## Central gas supply pressures



### WARNING

No central gas supply

#### Risk of oxygen deficiency

- Open the reserve gas bottles on the rear.
- Switch to manual ventilation.

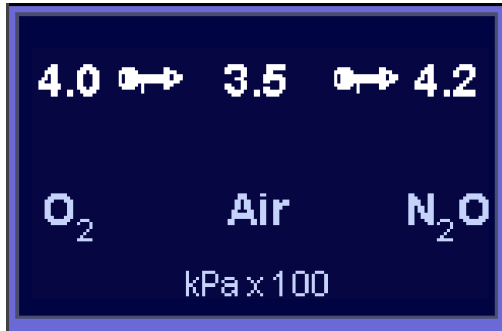

#### Pressure display with intact central gas supply

With an intact CGS the pressures of the central gas supply are displayed in white on the bottom of the **Threshold** window.

The supply plug icon marks that the pressure of the CGS is displayed.

- 💡 *An CGS gas is judged available if its pressure is over 1.1 kPa × 100 (bar). Below 2.5 kPa × 100 (bar) counts as too low.*



#### Pressure display when no central gas supply

With no CGS the pressures of the central gas supply are displayed in red.

If the leon *plus* is supplied with fresh gas from 2 L or 3 L gas bottles only, this is only marked by a message in the alarm window.

- 💡 *If only 2 L or 3 L reserve gas bottles are attached, AIR is not available as a drive gas. Ventilation is only possible in the MAN/SPONT form of ventilation. The reserve bottle pressure can be read from the manometers on the front of the leon plus .*
- 💡 *(→ "O2, flush, vacuum, manometers" p. 55).*

## Pressure display when supply from 10 L bottles

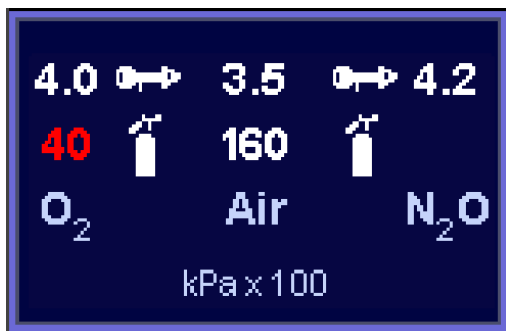

If the *leon plus* is supplied with fresh gas via 10 L gas bottles and the pressure of the bottles is monitored, this is marked by a gas bottle icon. The value (40 kPa × 100 (bar)) next to the bottle icon is the pressure of the 10 L bottle. The value next to the supply plug icon (4.0 kPa × 100 (bar)) displays the pressure at the gas inlet of the *leon plus*.

The following combinations can be attached as 10 L bottles:

- O<sub>2</sub> only
- N<sub>2</sub>O only
- AIR only
- O<sub>2</sub>, AIR
- O<sub>2</sub>, N<sub>2</sub>O

💡 An AIR or O<sub>2</sub> bottle is judged full if its pressure is over 120 kPa × 100 (bar), and the N<sub>2</sub>O over 40 kPa × 100 (bar).

💡 The bottle icon with pressure of the 10 L bottle is only displayed if it is configured in the service (→ "Gas supply" p. 111).

💡 **Connecting 10 L bottles instead of CGS**  
(→ "10 L bottle connection instead of CGS" p. 74) The supply pressures on the device connection must be between 2.8 and 6.0 kPa × 100 (bar). If there is no 10 L AIR bottle connected, O<sub>2</sub> is used as drive gas. (→ "AIR and CGS 10 L bottle connection" p. 76).

💡 **Connecting 10 L bottles as reserve gas bottles**  
(→ "10 L bottle connection as reserve bottles" p. 75) The supply pressures on the device connection must be between 1.8 and 2.0 kPa × 100 (bar). If AIR is not available as the drive gas and O<sub>2</sub> runs in reserve gas bottle operation, ventilation is only possible in the MAN/SPONT form of ventilation.

## Drive gas generator

If the drive gas generator fails, the buttons for selecting mechanical forms of ventilation are inactive. The device switches automatically to the MAN/SPONT form of ventilation. Alarm message **“Driving gas blender failed. Only Man/Spont possible”** is given.



### AIR as drive gas

AIR is used as the drive gas by default (fresh gas supply via the CGS). If the leon *plus* is supplied with fresh gas via 10 L O<sub>2</sub> gas bottles and AIR, AIR is used as the drive gas.

💡 *The inlet pressures of the gases (AIR or O<sub>2</sub>) for the drive gas blender must be at least 1.5 kPa × 100 (bar). Otherwise it is deactivated. Then only the MAN/SPONT form of ventilation is possible.*



### O<sub>2</sub> as drive gas

If AIR fails as the drive gas (fault in the CGS), or if the leon *plus* is supplied with fresh gas via 10 L O<sub>2</sub> and N<sub>2</sub>O gas bottles, O<sub>2</sub> is used as the drive gas.

💡 *If AIR is not available as the drive gas and O<sub>2</sub> runs in the reserve gas bottle operation, only one ventilation is possible in the MAN/SPONT form of ventilation.*

## Gas measurement

The following are monitored:

- Gas measurement failed
- O<sub>2</sub> calibration
- occlusion of gas measurement bag
- change of watertrap

💡 *The gas concentrations against room air is automatically calibrated during operation.*



**CAUTION**

Gas measurement failure

### Undersupply of oxygen

- External monitoring, monitoring of the O<sub>2</sub>, CO<sub>2</sub> and anaesthesia gas concentration

### Fresh gas shortage

The filling of the system is monitored visually. In the event of a fresh gas shortage (the “System running empty” due to a leak or because the patient needs more fresh gas than supplied), the alarm message “**Fresh gas supply too small**” is given.

### Docking station with patient module

The correct locking of the patient module on the device is monitored electrically. If the patient module on the docking station is not locked properly to the device, the alarm message “**Patient module not locked. Ventilation stopped**” is given.

### CO<sub>2</sub> absorber

The position of the CO<sub>2</sub> absorber is monitored electrically. If the absorber is not turned all the way to the stop, the alarm message “**CO<sub>2</sub> absorber removed or not locked. Circulation system short-circuited**” is given.

### Fans

The maximum O<sub>2</sub> concentration in the housing of the *leon plus* should not exceed 25%. To guarantee this, the housing is ventilated with a fan. A useful side-effect is the cooling of the inside of the housing. If the fan fails, the alarm message “**Fan failed**” is given.

## Batteries



### Charge batteries (mains voltage available)

On the right of the title bar the plug icon appears in green as "Mains voltage available", the battery icon appears in white with the display of the charging status of the battery as a percentage.



### Battery operation

On the right of the title bar the plug icon appears in white as "No mains voltage available", the battery icon appears in green with the display of the remaining life of the battery in minutes.



### Battery low

In the title bar on the right the battery icon appears in yellow with the display of the remaining life as 10 minutes.



### Battery failure

In the title bar on the right the battery icon appears in red as "Battery failure".



### Batteries not connected

In the title bar on the right the battery icon appears struck through in red as "Battery not connected" or "Battery not available".

💡 (→ "Mains supply failure" p. 252)

## Stopwatch

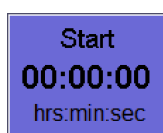

Stopwatch  
start

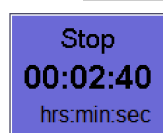

Stopwatch  
running



Stopwatch  
stopped

There is a stopwatch on the right in the forms of ventilation and ventilation parameters window. The time measurement is carried out in hh:mm:ss format. The maximum clockable time is 99:59:59. The operation is as follows:

- **Start:** Briefly touch the stopwatch on the touchscreen
- **Stop:** Briefly touch the stopwatch on the touchscreen again
- **Reset:** Keep the stopwatch on the touchscreen pressed down for longer than two seconds

💡 *Confirmation is also possible via the rotary button.*

## 11. Alarms

## General information

 **Caution!** - *The device may have other possible alarm limit settings or configurations as similar devices or the same type of device.*

Display of current alarms

## Display of alarms on the screen

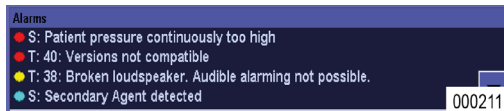

A maximum of four alarms can be displayed at the same time. The alarms have the following features:

- Priority
- Type
- Text
- tone

They are arranged in priority sequence, corresponding to their effect on the function of the device within the same priority, in a window displayed above the tab system. Technical alarms and system alarms also have error numbers.



If there are more than four alarms at the same time, to display the others, the list can be scrolled down via buttons in the window.



The alarm limits of the measured values displayed as real-time curves are marked in a broken line in the curve colour concerned.

### Alarm priorities

Table 39: Identification of alarm priorities

Priority	Colour Oval	Audible coding
high	red	continuous intermittent tone sequence
medium	yellow	intermittent tone sequence every 30 seconds
informative	pale blue	no tone sequence

The alarms are divided into three priorities. Each alarm is identified according to the priority by:

- a prefixed coloured oval
- tone (except for informative)

The alarms are arranged in a further six priorities within the same priority, according to their effect on the function of the device.

There are four alarms, which have an **informal** character in standby but have **high priority** during ventilation:

- O<sub>2</sub> emergency dosing active
- CO<sub>2</sub> absorber short-circuited
- no water trap
- patient module not locked

### Alarm types

Table 40: Alarm types

Type	Code	triggered by	fixable by
Patient	P	Patient	User
System	S	Technical fault	
Technology	T		Löwenstein Medical

The alarms are divided into three types, depending on the cause and its fixability. Technical alarms and system alarms also have error numbers.

 Please make a note of the error number before you notify a Löwenstein Medical-authorized service technician.

**Alarm volume**

(→ "Volume tab" p. 98)

**Saving alarm messages**

All alarm messages are saved when the device is shut down (turned off). In the event of a power failure, the device switches automatically to battery operation and, if the power supply is not restored after a further 100 minutes, powers down independently with a message.

**Factory settings of the alarms**

Table 41: Factory settings of the alarms

Alarm	Form of ventilation															
	Child								Adult							
	IMV	S-IMV	PCV	S-PCV	PSV	MAN/SPONT	HLM	MON	IMV	S-IMV	PCV	S-PCV	PSV	MAN/SPONT	HLM	MON
insp. O <sub>2</sub> [%] high	100															
insp. O <sub>2</sub> [%] low	25															
insp. CO <sub>2</sub> [mmHg] high	5.0							/	5.0							/
exp. CO <sub>2</sub> [mmHg] high	50.0							55.0								
exp. CO <sub>2</sub> [mmHg] low	0							0								
insp. HAL [%] high	3.0							/	3.0							/
insp. HAL [%] low	0							/	0							/
insp. ENF [%] high	5.0							/	5.0							/
insp. ENF [%] low	0							/	0							/
insp. ISO [%] high	3.5							/	3.5							/
insp. ISO [%] low	0							/	0							/
insp. SEV [%] high	3.5							/	3.5							/
Insp. SEV [%] low	0							/	0							/
insp. DES [%] high	10.0							/	10.0							/
insp. DES [%] low	0							/	0							/
FiO <sub>2</sub> [%] high	100							/	100							/



Table 41: Factory settings of the alarms

Alarm	Form of ventilation															
	Child								Adult							
	IMV	S-IMV	PCV	S-PCV	PSV	MAN/SPONT	HLM	MON	IMV	S-IMV	PCV	S-PCV	PSV	MAN/SPONT	HLM	MON
FiO <sub>2</sub> [%] low	25							/	25							/
Leak [%]	50						/	/	50						/	/
Apnoea [s]	/				30	/	/	/				30	/	/		
MV [l/min] high	9.0					/	/	/	12.0					/	/	/
MV [l/min] low	2.0					/	/	/	3.0					/	/	/
V <sub>Te</sub> [ml] low	100					/	/	/	300					/	/	/
P <sub>Peak</sub> [mbar]	P <sub>max</sub> + 5	P <sub>insp.</sub> + 10			35	/	/	P <sub>max</sub> + 5	P <sub>insp.</sub> + 10			40	/	/		
CPAP [mbar]	/						20	/	/						20	/
Freq <sub>CO2</sub> high	/							100	/							100
Freq <sub>CO2</sub> low	/							4	/							4

## Alarm muting

**Alarm muting 2 minutes**

Alarms muted!

**Risk of oxygen deficiency**

Any alarms that occur are only displayed visually.

- Watch the ventilation, while the alarms are muted.
- Be extra vigilant.



The **Mute** button is positioned on the bottom right of the keypad. By pressing **Mute**, the audible alarm for all currently pending alarms is muted for two minutes. Re-pressing deactivates mute.

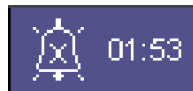

If Mute is activated, a minute counter appears in the title bar in mm:ss format, which displays the remaining mute time.

(→ "Mute 2 min." p. 54)

- High or medium-prioritised alarms are audibly renewed every 120 seconds.
- If during the mute time a new alarm with higher priority than the existing alarm appears the alarm sounds immediately. Mute is lifted.
- If during the mute time a new alarm with the same or lower priority than the existing alarm appears the alarm does not sound until the mute time has elapsed. This behaviour applies only to alarms of medium and informative priority. Higher priority alarms always go through. Mute is then lifted.
- If during the mute time there is no alarm the mute function is cancelled early. The next alarm to appear sounds according to its priority.
- Informative priority alarms are deleted from the alarm window if the **Mute** button is pressed.

## 10 minute alarm muting

---



Alarms muted!

### Risk of oxygen deficiency

Any alarms that occur are only displayed visually.

- Watch the ventilation, while the alarms are muted.
  - Be extra vigilant.
- 

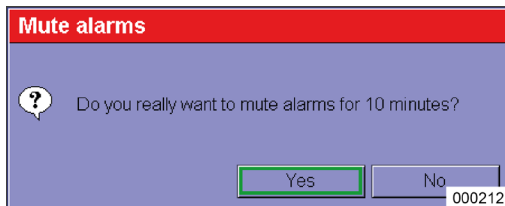

In the MAN/SPONT form of ventilation, an adjacent screen dialogue appears, if the Mute button is pressed for longer than 2 seconds. If the dialogue is confirmed with Yes, all alarms are muted for 10 minutes. Re-pressing of the button deactivates mute.



A minute counter appears in the title bar (→ "Mute 10 min." p. 54) in mm:ss format, highlighted in red, which displays the remaining mute time.



*System alarms and technical alarms are audibly sounded and mute is reset.*

## Alarm log

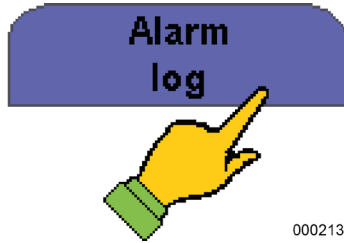

1. Select the appropriate tab to call up the alarm log.

All alarms are stored and saved chronologically in the alarm log. Before each alarm text the appearance and time difference to the current time are displayed. They are given a coloured oval according to their priority (→ "Alarm priorities" p. 201) and a suffix according to their type (→ "Alarm types" p. 201). The window can be scrolled if its size is not sufficient to display all of the occurring alarms.

- 💡 *If the device is shut down properly, the data are kept and available on restart. The shutdown time of the device is also logged. In the event of a complete mains failure, data that have been added since the last proper shutdown are not lost.*
- 💡 *If the capacity limit of the alarm log store is reached, the oldest data are deleted (fifo)*
- 💡 *The alarm log can only be seen during the ventilation. In standby it is part of the event log.*

Limit values (patient alarm limits)

**Setting patient alarm limits manually**

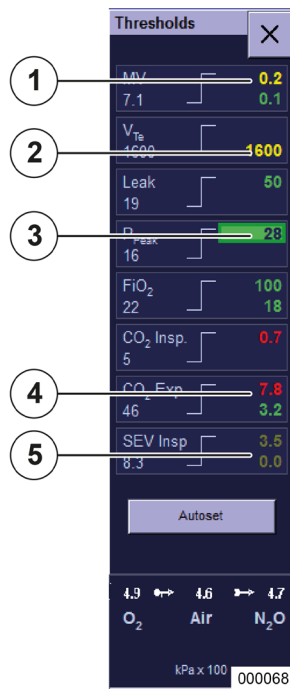

This window can only be opened via a button on the keyboard. After opening, the current active alarm is selected. If an alarm is active and the window is already open, this alarm must be manually selected.

- (1) Medium priority alarm exceeded (value in yellow)
  - (2) High priority alarm exceeded (value in red)
  - (3) Currently selected alarm (highlighted according to the colour of its priority)
  - (4) Unexceeded alarm (value in green)
  - (5) Inactive alarm (value in brown)
- (→ "Active alarms" p. 212)



1. To edit alarm limits, open the Thresholds window.



2. If the window is already open, focus it, select an alarm in the window and set the upper and lower alarm limits.

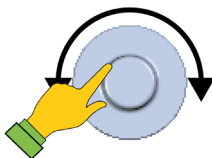

- 3. Set the parameters.
- 4. Confirm the entry.



5. Close the window.

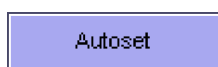

**Further control elements in the Thresholds window:**

Adapting active alarms to the current measured value.

(→ "Adjusting alarm limits to current measured value (autoset)" p. 211)

## Adjustable alarm limits

---

The following alarm limits can be adjusted in the window:

Pressures

- P<sub>aw</sub> ventilation pressure
- CPAP

Volume

- expiratory MV breath minute volume
- expiratory V<sub>Te</sub> breath volume

Patient gases

- CO<sub>2</sub> (inspiratory and expiratory)
- O<sub>2</sub> (inspiratory)/ FiO<sub>2</sub>
- volatile anaesthetics (inspiratory)
  - halothane
  - enflurane
  - isoflurane
  - sevoflurane
  - desflurane

Leak

Apnoea

Freq<sub>CO2</sub>

## Display of apnoea duration

---



In the MAN/SPONT form of ventilation, the time that has passed since the last breath (apnoea duration) is shown at the bottom left of the Limit Values window under the entry “Apnoea”.

The adjustable alarm limit for “Apnoea” is on the bottom right.

💡 *In the MAN/SPONT form of ventilation, the MV minute volume is not displayed as a limit value.*

### Application area and increment of alarm

Table 42: Application area and increment of alarm

Alarm	Increment	Form of ventilation															
		Child							Adult								
		IMV	S-IMV	PCV	S-PCV	PSV	MAN/SPONT	MON	HLM	IMV	S-IMV	PCV	S-PCV	PSV	MAN/SPONT	MON	HLM
insp. O <sub>2</sub> [%] high	1			19-99				/	/			19-99				/	/
insp. O <sub>2</sub> [%] low	1			18-98								18-98					
insp. CO <sub>2</sub> [%] high	0.1			0-1.5				/	/			0-1.5				/	/
exp. CO <sub>2</sub> [%] high	0.1			0.1-10				/	/			0.1-10				/	/
exp. CO <sub>2</sub> [%] low	0.1			0-9.9				/	/			0-9.9				/	/
insp. HAL [%] high	0.1			0.1-10				/	/			0.1-10				/	/
insp. HAL [%] low	0.1			0-9.9				/	/			0-9.9				/	/
insp. ENF [%] high	0.1			0-10				/	/			0-10				/	/
insp. ENF [%] low	0.1			0-9.9				/	/			0-9.9				/	/
insp. ISO [%] high	0.1			0.1-10				/	/			0.1-10				/	/
insp. ISO [%] low	0.1			0-9.9				/	/			0-9.9				/	/
insp. SEV [%] high	0.1			0.1-10				/	/			0.1-10				/	/
insp. SEV [%] low	0.1			0-9.9				/	/			0-9.9				/	/
insp. DES [%] high	0.1			0.1-22				/	/			0.1-22				/	/
insp. DES [%] low	0.1			0-21.9				/	/			0-21.9				/	/
FiO <sub>2</sub> [%] high	1			19-99				/	/			19-99				/	/
FiO <sub>2</sub> [%] low	1			18-98				/	/			18-98				/	/
Leak [%]	1			10-100				/	/			10-100				/	/
Apnoea [s]	1		/				10-60	/	/		/				10-60	/	/

Table 42: Application area and increment of alarm

Alarm	Increment	Form of ventilation														
		Child							Adult							
		IMV	S-IMV	PCV	S-PCV	PSV	MAN/SPONT	MON	HLM	IMV	S-IMV	PCV	S-PCV	PSV	MAN/SPONT	MON
MV [l/min] high	0.1	0.2-30			/	/	/	0.1-30			/	/	/			
MV [l/min] low	0.1	0.1-19.9			/	/	/	0-19.9			/	/	/			
V <sub>Te</sub> [ml] low	10	10-600			/	/	/	50-1600			/	/	/			
P <sub>Peak</sub> [mbar]	1	P <sub>max</sub> + 5 - 85	PEEP + 5 -		P <sub>insp.</sub> + 10	10-85	/	/	P <sub>max</sub> + 5 - 85	PEEP + 5 -		P <sub>insp.</sub> + 10	10-85	/	/	/
CPAP [mbar]	1	/			/	/	5-60	5-60	/			/	/	5-60	5-60	
Freq <sub>CO2</sub> high	1	/			/	/	/	/	/			/	/	/	/	
Freq <sub>CO2</sub> low	1	/			/	/	/	/	/			/	/	/	/	



## Adjusting alarm limits to current measured value (autoset)

The alarm limits for the following measured values can be adjusted via autoset:

Table 43: Autoset alarms

Alarm	Form of ventilation											
	Child						Adult					
	IMV	S-IMV	PCV	S-PCV	PSV	MAN/SPONT, MON, HLM	IMV	S-IMV	PCV	S-PCV	PSV	MAN/SPONT, MON, HLM
MV [l/min] high at least	$V_{Te} \times f \times 1,4$ 2.0		$MV \times 1,4$ 2.0			/	$V_{Te} \times f \times 1,4$ 2.0		$MV \times 1,4$ 2.0			/
MV [l/min] low at least	$V_{Te} \times f \times 0,6$ 0.5		$MV \times 0,6$ 0.5			/	$V_{Te} \times f \times 0,6$ 0.5		$MV \times 0,6$ 0.5			/
$V_{Te}$ [ml] low	$V_{Ti} \times 0,6$					/	$V_{Ti} \times 0,6$					/
$P_{peak}$ [mbar]	$P_{max} + 5$		$P_{plateau} + 10$			/	$P_{max} + 5$		$P_{plateau} + 10$			/



The alarm limit is automatically adjusted only if the set alarm limit is exceeded.

## Alarm limits that are automatically followed

Table 44: automatically followed alarms

Alarm	Range (adjustable in the service)	Increment
$P_{Peak}$ [cm H <sub>2</sub> O]	$P_{insp.} + 5 - P_{insp.} + 30$	1

To avoid alarms being triggered by deliberate settings, the pressure-controlled form of ventilation of the  $P_{Peak}$  pressure alarm is automatically followed:

- $P_{Peak}$  airway pressure alarm during changes of  $P_{insp.}$  with pressure-controlled forms of ventilation

## Active alarms

Only certain alarms are active depending on whether the ventilation is mechanical or manual, or the patient breathes spontaneously. Inactive alarms are displayed as brown in the Threshold window.

(→ "Setting patient alarm limits manually" p. 207)

To mute alarms see:

(→ "Alarm muting" p. 204)

Table 45: active alarms

Alarm	active			
	IMV, PCV, S-IMV, S-PCV, PSV	MAN/SPONT	HLM	MON
insp. O <sub>2</sub> [%] high	immediately after the start of a ventilation	immediately after the start of the ventilation	no	immediately after the start of the ventilation
insp. O <sub>2</sub> [%] low	30 seconds after the start of a ventilation	30 seconds after the start of the ventilation	no	30 seconds after the start of the ventilation
insp. CO <sub>2</sub> [%] high	after the first detection of a breath	after the first detection of a breath	no	is not displayed
exp. CO <sub>2</sub> [%] high/low	immediately after the start of a ventilation	immediately after the start of the ventilation	no	immediately after the start of the ventilation
vol. insp. anaesthetic [%] high/low	after the first detection of a breath	after the first detection of a breath	no	is not displayed
FiO <sub>2</sub> [%] high	immediately after the start of a ventilation	immediately after the start of the ventilation	no	is not displayed

Table 45: active alarms

Alarm	active			
	IMV, PCV, S-IMV, S-PCV, PSV	MAN/SPONT	HLM	MON
FiO <sub>2</sub> [%] low	30 seconds after the start of a ventilation	30 seconds after the start of the ventilation	no	is not displayed
MV [l/min] low	30 seconds after the start of a ventilation	is not displayed	is not displayed	is not displayed
MV [l/min] high	immediately after the start of a ventilation	is not displayed	is not displayed	is not displayed
V <sub>Te</sub> [ml] low	30 seconds after the start of a ventilation	no	no	is not displayed
P <sub>peak</sub> [mbar]	immediately after the start of a ventilation	immediately after the start of the ventilation	is not displayed	is not displayed
CPAP [mbar]	is not displayed	is not displayed	immediately after the start of the ventilation	immediately after the start of the ventilation
Leak [%]	30 seconds after the start of a ventilation	30 seconds after the start of a ventilation	no	is not displayed
Apnoea [s]	is not displayed	30 seconds after the start of the ventilation	is not displayed	is not displayed
Freq <sub>CO2</sub> high/low	is not displayed	is not displayed	is not displayed	immediately after the start of the ventilation

## List of alarm messages

Table 46: List of all alarm messages

Alarm message	No.	Description	Removal	Limit value	Filtering	0 = inactive 1 = active 1/0 = can be deactivated										Priority (Dialogue, Info, Medium, High)	Code (Patient, Technical, System)	
						Self check	Standby	MAN/SPONT	IMV	S-IMV	PCV	S-PCV	PSV	HLM	MON			
Air supply failed. Fresh gas with 100% O <sub>2</sub>	177	Air supply failed	Restore air supply CGS	< 1.1 bar	2 s	0	1/0	1/0	1/0	1/0	1/0	1/0	1/0	1/0	1/0	1/0	I	S
Air and N <sub>2</sub> O failed. Fresh gas O <sub>2</sub>	183	Air and N <sub>2</sub> O supply failed	Restore CGS air and N <sub>2</sub> O supply	AIR < 1.1 bar N <sub>2</sub> O < 1.1 bar	2 s	0	1/0	1/0	1/0	1/0	1/0	1/0	1/0	1/0	1/0	1/0	I	S
Air supply failed	178	Air supply failed	Restore air supply CGS	AIR < 1.1 bar	2 s	0	1/0	1/0	1/0	1/0	1/0	1/0	1/0	1/0	1/0	1/0	I	S
Air CGS input pressure too high	160	Compressed air supply too high	Check CGS compressed air	AIR > 7.5 bar	> 10 s	0	1	1	1	1	1	1	1	1	1	1	I	S
Rechargeable battery empty	133	Remaining battery runtime 0 min. reached	Restore mains supply. Not possible during operation. Only resettable via reboot	1 min	-	0	1	1	1	1	1	1	1	1	1	1	H	S
Rechargeable battery empty	134	Battery voltage < 21V	Restore mains supply. Not possible during operation. Only resettable via reboot	22.1 V	> 20 s	0	1	1	1	1	1	1	1	1	1	1	H	S

Table 46: List of all alarm messages

Alarm message	No.	Description	Removal	Limit value	Filtering	0 = inactive 1 = active 1/0 = can be deactivated										Priority (Dialogue, Info, Medium, High)	Code (Patient, Technical, System)
						Self check	Standby	MAN/SPONT	IMV	S-IMV	PCV	S-PCV	PSV	HLM	MON		
Battery failure. Please replace.	1	Battery faulty	Replace / repair	-	-	0	1	1	1	1	1	1	1	1	1	M	T
	2	Battery charge / monitoring hardware fail				0	1	1	1	1	1	1	1	1	1	1	M
Battery incorrectly connected or damaged	3	Batteries not correctly connected	Connect batteries correctly	-	-	0	1	1	1	1	1	1	1	1	M	T	
Batteries almost empty	131	Remaining battery runtime < 10 min	Restore mains supply	11 min	-	0	1	1	1	1	1	1	1	1	M	S	
	132	Battery voltage too low		22.5 V	> 20 s	0	1	1	1	1	1	1	1	1	M	S	
Batteries deep discharged. Please calibrate.	41	Battery deep discharged/damaged (capacity reduced)	Change batteries	-	-	1	0	0	0	0	0	0	0	0	M	T	
Alarm log full. Oldest entries deleted.	191	-	-	1000	-	1	1	1	1	1	1	1	1	1	I	S	
Apnoea	354	No breath detected for a long period	Check ventilation tube system	(→ "Application area and increment of alarm" p. 209)	-	0	0	1	0	0	0	0	0	0	H	P	
Apnoea backup breath was triggered	301	Backup breath in the PSV mode was emitted (apnoea)	Patient does not trigger, forced breath is triggered by machine	-	-	0	0	0	0	0	0	1	0	0	I	P	

Table 46: List of all alarm messages

Alarm message	No.	Description	Removal	Limit value	Filtering	0 = inactive 1 = active 1/0 = can be deactivated										Priority (Dialogue, Info, Medium, High)	Code (Patient, Technical, System)
						Self check	Standby	MAN/SPONT	IMV	S-IMV	PCV	S-PCV	PSV	HLM	MON		
Apnoea CO <sub>2</sub>	353	Disconnection AION/IRMA	Check multi-gas analyser tube system	-	-	0	0	1	0	0	0	0	0	0	1	H	P
Gas measurement failure	81	Measurement (probably) wrong	Not possible during operation. Can only be reset via reboot (possible replacement/repair)	-	-	0	1	1	1	1	1	1	1	1	1	H	T
FiO <sub>2</sub> Sensor Fail. Please change cell.	18	Voltage O <sub>2</sub> cell too small. Old cell	Change cell	75 ADC	6 s	0	1	1	1	1	1	1	1	1	1	H	T
Gas measurement failed	82	Broken Artema AION	Replace / repair	-	-	1	1	1	1	1	1	1	1	1	1	H	T
Blender failed. Turn on emergency dosing!	72	Fresh gas flow too high	Successful check in system test	170 (not for $\dot{V} < 2$ l/min)	120 s	0	1	1	1	1	1	1	1	1	1	H	T
	73	Fresh gas flow too low		30 (not for $\dot{V} < 2$ l/min)	120 s	0	1	1	1	1	1	1	1	1	1	H	T
	76	FG blender check O <sub>2</sub> in system test failed		-	-	0	1	1	1	1	1	1	1	1	1	H	T
	80	FG flow measurement disconnected. Cable for FG blender valves probably also pulled out -> fail FG dosing		< 20 ADC	30 s	0	1	1	1	1	1	1	1	1	1	H	T

Table 46: List of all alarm messages

Alarm message	No.	Description	Removal	Limit value	Filtering	0 = inactive 1 = active 1/0 = can be deactivated										Priority (Dialogue, Info, Medium, High)	Code (Patient, Technical, System)
						Self check	Standby	MAN/SPONT	IMV	S-IMV	PCV	S-PCV	PSV	HLM	MON		
O <sub>2</sub> measurement failed. Please calibrate O <sub>2</sub> Cell.	135	The Servomex sensor must be calibrated (together with the multi-gas analyser)	Calibrate gas measurement (service)	-	-	0	1	1	1	1	1	1	1	1	1	H	S
No drive gas. Only MAN/SPONT possible	165	No drive gas for mechanical ventilation	Successful check in system test	O <sub>2</sub> < 1.5 Bar AIR < 1.5 bar	2 s	0	1	1	1	1	1	1	1	1	1	H	S
	166	No drive gas for mechanical ventilation		O <sub>2</sub> < 1.1 bar	2 s	0	1	0	1	1	1	1	0	0	H	S	
No drive gas. Only MAN/SPONT possible.	69	Drive gas blender check failed in system test	Successful check in system test	-	-	0	1	1	1	1	1	1	1	1	H	T	
No drive gas blender. Only MAN/SPONT possible.	79	No drive gas supplied (drive gas blender failed, disconnected/dropped off drive gas tube, blockage drive gas channel)	Successful drive gas blender check in system test	$V_{Ti} < 3 \text{ ml}$ $\dot{V}_{max} < 500 \text{ ml/min}$ $P_{max} - P_{Peep} < 1 \text{ mbar}$ $V_{Te} \geq V_{Ti} \times 0,5 \%$	5 breaths	0	0	0	1	1	1	1	1	0	0	H	T

Table 46: List of all alarm messages

Alarm message	No.	Description	Removal	Limit value	Filtering	0 = inactive 1 = active 1/0 = can be deactivated										Priority (Dialogue, Info, Medium, High)	Code (Patient, Technical, System)	
						Self check	Standby	MAN/SPONT	IMV	S-IMV	PCV	S-PCV	PSV	HLM	MON			
Ventilation and fresh gas stopped.	45	If the error is not fixed by a restart or it is repeated, make a note of the error number and notify a service technician authorised by Löwenstein Medical	Not possible during operation. Only resettable via reboot Use the O <sub>2</sub> emergency dosing	-	-	1	1	1	1	1	1	1	1	1	1	H	T	
Checksum error	84	Wrong or faulty file	Reinstall software	-	-	1	1	1	1	1	1	1	1	1	1	H	T	
CO <sub>2</sub> absorber removed. Circle system short-circuited.	148	CO <sub>2</sub> absorber was removed. Circle system short-circuited	Fit absorber	-	-	0	0	1	1	1	1	1	1	1	1	H	S	
	149					0	1	0	0	0	0	0	0	0	0	0	I	S
Expiratory CO <sub>2</sub> high	312	Expiratory CO <sub>2</sub> too high	Change ventilation parameters	(→ "Application area and increment of alarm" p. 209)	3 breaths	0	0	1	1	1	1	1	1	0	1	H	P	
Expiratory CO <sub>2</sub> low	313	Expiratory CO <sub>2</sub> too low				0	0	1	1	1	1	1	1	1	0	1	M	P
Inspiratory CO <sub>2</sub> high	311	Inspiratory CO <sub>2</sub> too high	Change vaporiser setting			0	0	1	1	1	1	1	1	0	1	H	P	
Insp. DES too high	322	Inspiratory desflurane too high				0	0	1	1	1	1	1	1	1	0	1	H	P
Insp. DES too low	323	Inspiratory desflurane too low				0	0	1	1	1	1	1	1	1	0	1	M	P



Table 46: List of all alarm messages

Alarm message	No.	Description	Removal	Limit value	Filtering	0 = inactive 1 = active 1/0 = can be deactivated										Priority (Dialogue, Info, Medium, High)	Code (Patient, Technical, System)
						Self check	Standby	MAN/SPONT	IMV	S-IMV	PCV	S-PCV	PSV	HLM	MON		
Disconnection. Check tube system.	350	Tube system not connected (inspiratory)	Check ventilation tube system	3 mbar	2 breaths	0	0	0	1	1	1	1	1	0	0	H	P
	351	Tube system not connected (expiratory)		<PEEP Setting +2 mbar	2 breaths	0	0	0	1	1	1	1	1	0	0	H	P
	352	Tube system interrupted (between y-piece and tube or between tube and patient)		$\dot{V} > 2000$ (adult) ml $\dot{V} > 700$ (child) if ( $p_{peak} - PEEP$ setting) < 7 mbar	2 breaths	0	0	0	0	0	1	1	1	0	0	H	P
	357	Tube system not connected (Flow)		$V_{Te} < 25\%$ of $V_{Ti}$ % PEEP < 2 mbar	-	0	0	0	1	1	1	1	1	0	0	H	P
Rotary switch without function	85	Rotary switch is without function	Not possible during operation. Only resettable via reboot	-		1	1	1	1	1	1	1	1	1	H	T	
Set pressure $P_{insp}$ not reachable.	307	Pressure not reached	Change ventilation parameters	-	2 breaths	0	0	0	0	0	1	1	1	0	0	M	P
Set volume $V_{Ti}$ not reachable.	305	Volume not reached		0	0	0	1	1	0	0	0	0	0	0	M	P	

Table 46: List of all alarm messages

Alarm message	No.	Description	Removal	Limit value	Filtering	0 = inactive 1 = active 1/0 = can be deactivated										Priority (Dialogue, Info, Medium, High)	Code (Patient, Technical, System)
						Self check	Standby	MAN/SPONT	IMV	S-IMV	PCV	S-PCV	PSV	HLM	MON		
Insp. ENF too high	316	Inspiratory enflurane too high	Change vaporiser setting/	(→ "Application area and increment of alarm" p. 209)	3 breaths	0	0	1	1	1	1	1	1	0	1	H	P
Insp. ENF too low	317	Inspiratory enflurane too low				0	0	1	1	1	1	1	1	1	0	1	M
Expiration condition not reached	302	Exhalation condition in the PSV not reached (25% of peak flow, pressure not reached)	Change ventilation parameters	25% of $\dot{V}_{max}$	2 breaths	0	0	0	0	0	0	1	0	0	I	P	
Ext. fresh gas active	112	Manual switch-over to external fresh gas outlet	Set external fresh gas to 0	-	-	0	1	1	0	0	0	0	0	1	1	I	S
	113					0	0	0	1/0	1/0	1/0	1/0	1/0	0	0	H	S
Check external O <sub>2</sub> measurement	229	No oxygen measurement patient	Enable external O <sub>2</sub> measurement (fit O <sub>2</sub> cell)	-	30 s	1	0	0	0	0	0	0	0	0	I	S	
Failure during communication with VueLink	193	VueLink connection available but data incorrectly transferred	Received valid requests/ VueLink deactivated	-	-	0	1	1	1	1	1	1	1	1	I	S	
Calibrate FiO <sub>2</sub> cell	140	FiO <sub>2</sub> sensor not or incorrectly calibrated	Calibrate cells	105 %	> 3 s	0	1	1	1	1	1	1	1	1	H	S	
FiO <sub>2</sub> too high	331	Insp. oxygen concentration too high	Change ventilation parameters	(→ "Application area and increment of alarm" p. 209)	3 breaths	0	0	1	1	1	1	1	1	0	0	M	P
FiO <sub>2</sub> too low	330	Insp. oxygen concentration too low				0	0	1	1	1	1	1	1	1	0	0	H

Table 46: List of all alarm messages

Alarm message	No.	Description	Removal	Limit value	Filtering	0 = inactive 1 = active 1/0 = can be deactivated										Priority (Dialogue, Info, Medium, High)	Code (Patient, Technical, System)
						Self check	Standby	MAN/SPONT	IMV	S-IMV	PCV	S-PCV	PSV	HLM	MON		
Flow and volume measurement not possible.	66	No flow sensor available (= unplugged)	Successful check in system test	$\dot{V} < 15 \text{ ADC}$	90 s	0	0	0	1	1	1	1	1	0	0	H	T
FreqCO <sub>2</sub> too high	360	Breathing rate too high	-	100 l/min	-	0	0	0	0	0	0	0	0	0	1	H	P
FreqCO <sub>2</sub> too low	361	Breathing rate too low	-	0 l/min	-	0	0	0	0	0	0	0	0	0	1	H	P
Fresh gas shortage	341	Fresh gas shortage	Increase fresh gas flow	-	5 breaths	0	0	0	1	1	1	1	1	0	0	H	P
Gas measurement unreliable	136	Measurement cannot be guaranteed.	Not possible during operation. Can only be reset via reboot (possible replacement/repair)	-	-	0	1	1	1	1	1	1	1	1	1	M	S
Gas measurement: O <sub>2</sub> cell depleted	137	O <sub>2</sub> cell depleted	Insert new O <sub>2</sub> cell	-	-	0	1	1	1	1	1	1	1	1	1	H	S
Calibrating gas measurement	138	Multi-gas analyser in calibration mode; no measured values	-	-	-	0	1	1	1	1	1	1	1	1	1	I	T

Table 46: List of all alarm messages

Alarm message	No.	Description	Removal	Limit value	Filtering	0 = inactive 1 = active 1/0 = can be deactivated										Priority (Dialogue, Info, Medium, High)	Code (Patient, Technical, System)	
						Self check	Standby	MAN/SPONT	IMV	S-IMV	PCV	S-PCV	PSV	HLM	MON			
Insp. HAL too high	314	Inspiratory halothane too high	Change vaporiser setting	(→ "Application area and increment of alarm" p. 209)	3 breaths	0	0	1	1	1	1	1	1	0	1	H	P	
Insp. HAL too low	315	Inspiratory halothane too low				0	0	1	1	1	1	1	1	1	0	1	M	P
Insp. ISO too high	318	Inspiratory isoflurane too high				0	0	1	1	1	1	1	1	1	0	1	H	P
Insp. ISO too low	319	Inspiratory isoflurane too low				0	0	1	1	1	1	1	1	1	1	1	M	P
No anaesthetic gas recognised.	122	Anaesthetic gas no longer recognised	-	-	-	0	1	1	1	1	1	1	1	1	1	I	S	
No N <sub>2</sub> O detected in system test	75	FG blender check N <sub>2</sub> O in system test failed	Successful check in system test	-	-	0	1	1	1	1	1	1	1	1	1	I	T	
No secondary anaesthetic gas recognised.	124	Anaesthetic gas no longer recognised	-	-	-	0	1	1	1	1	1	1	1	1	1	I	S	
Audible alarm not possible.	38	Broken loudspeaker	Replace / repair	-	-	1	1	1	1	1	1	1	1	1	1	M	T	
No decompression during expiration	190	Pressure cannot be reduced in the system (valve clips)	Check PEEP valve	PEEP Setting + 5 mbar	> = 16 s	0	0	0	1	1	1	1	1	0	0	H	S	

Table 46: List of all alarm messages

Alarm message	No.	Description	Removal	Limit value	Filtering	0 = inactive 1 = active 1/0 = can be deactivated										Priority (Dialogue, Info, Medium, High)	Code (Patient, Technical, System)
						Self check	Standby	MAN/SPONT	IMV	S-IMV	PCV	S-PCV	PSV	HLM	MON		
No exp. volume measurement	65	Faulty exp. flow sensor	Successful check in system test	$\dot{V}_{const.} \leq 15 \text{ ADC}$	90 s	0	0	0	1	1	1	1	1	0	0	H	T
	118	ADC value at stop for a long time	Clean flow sensor	$> 2750 \text{ ADC}$	4 s	0	1	1	1	1	1	1	1	1	1	H	S
No insp. volume measurement	64	Faulty insp. flow sensor	Successful check in system test	$\dot{V}_{const.} \leq 15 \text{ ADC}$	90 s	0	0	0	1	1	1	1	1	0	0	H	T
	117	ADC value at stop for a long time	Clean flow sensor	$> 2750 \text{ ADC}$	4 s	0	1	1	1	1	1	1	1	1	1	H	S
No check of audible alarm	83	Broken microphone	Replace / repair	-	-	1	0	0	0	0	0	0	0	0	0	M	T
No volume measurement. Execute system test.	130	Zero point adjustment flow sensor not calibrated	Successful calibration in system test	$\dot{V}_{Offset.} > 0.5 \text{ l/m}$ $-0.5 \text{ l/m}$	$> 2 \text{ s}$	0	1	0	0	0	0	0	0	0	0	H	S
No watertrap	127	No watertrap available	Fit watertrap	-	-	0	0	1	1	1	1	1	1	1	1	H	S
	128				-	0	1	0	0	0	0	0	0	0	0	I	S
Leak too high	358	$2 \times V_{Ti} > V_{Te}$	Look for leak	(→ "Application area and increment of alarm" p. 209)	3 breaths	0	0	1	1	1	1	1	1	0	0	M	P
Fan fail	5	Fan fault	Replace / repair	-	-	0	1	1	1	1	1	1	1	1	1	I	T
Gas measurement occlusion	126	Sample line occluded	Remove sample line obstruction	-	-	0	1	1	1	1	1	1	1	1	1	H	S

Table 46: List of all alarm messages

Alarm message	No.	Description	Removal	Limit value	Filtering	0 = inactive 1 = active 1/0 = can be deactivated										Priority (Dialogue, Info, Medium, High)	Code (Patient, Technical, System)
						Self check	Standby	MAN/SPONT	IMV	S-IMV	PCV	S-PCV	PSV	HLM	MON		
Blender fail. Fresh gas with 100% O <sub>2</sub>	19	Voltage O <sub>2</sub> cell too small. Old cell	Change cell	75 ADC	30 s	0	0	1	1	1	1	1	1	1	1	H	T
Blender fail. Fresh gas with 100% O <sub>2</sub>	70	Oxy desired state deviation on blender outlet	Successful check in system test	< 20 %	30 s downwards 120 s upwards	0	0	1	1	1	1	1	1	1	1	H	T
	71	FG O <sub>2</sub> calibration in system test failed		-	-	0	1	1	1	1	1	1	1	1	1	H	T
	74			0	1	1	1	1	1	1	1	1	1	H	T		
	141	FG O <sub>2</sub> sensor not or incorrectly calibrated		< 16 %	> 30 s	0	1	1	1	1	1	1	1	1	1	H	S
MV high	334	Minute volume too high	Change ventilation parameters	(→ "Application area and increment of alarm" p. 209)	3 breaths	0	0	1/0	1/0	1/0		1/0	0	0	M	P	
MV low	333	Minute volume too low				0	0	1/0	1	1	1	1	1	0	0	H	P
N <sub>2</sub> O fail. Fresh gas with 100% O <sub>2</sub>	179	N <sub>2</sub> O (CGS and reserve) supply fail	Restore N <sub>2</sub> O supply (CGS or reserve)	< 1.1 bar	2 s	0	1/0	1/0	1/0	1/0	1/0	1/0	1/0	1/0	1/0	I	S
N <sub>2</sub> O supply on reserve	182	N <sub>2</sub> O CGS supply fail. Reserve ok	Restore N <sub>2</sub> O supply CGS	PS5 > 1.1 bar PS4 < PS5 u, PS4 < 2.5	10 s	0	1/0	1/0	1/0	1/0	1/0	1/0	1/0	1/0	1/0	I	S
N <sub>2</sub> O supply fail	180	N <sub>2</sub> O (CGS and reserve) supply fail	Restore N <sub>2</sub> O supply (CGS or reserve)	< 1.1 bar	2 s	0	1/0	1/0	1/0	1/0	1/0	1/0	1/0	1/0	1/0	I	S

Table 46: List of all alarm messages

Alarm message	No.	Description	Removal	Limit value	Filtering	0 = inactive 1 = active 1/0 = can be deactivated										Priority (Dialogue, Info, Medium, High)	Code (Patient, Technical, System)
						Self check	Standby	MAN/SPONT	IMV	S-IMV	PCV	S-PCV	PSV	HLM	MON		
N <sub>2</sub> O CGS input pressure too high	161	N <sub>2</sub> O CGS supply pressure too high	Check pressure N <sub>2</sub> O CGS	> 7.5 bar	> 10 s	0	1	1	1	1	1	1	1	1	1	I	S
N <sub>2</sub> O CGS too low	181	N <sub>2</sub> O CGS supply has low input pressure but still supplies gas	Check N <sub>2</sub> O supply CGS	1.1 < PS4 < 2.5 at bar N <sub>2</sub> O consumption > 0 PS4 < 2.5 with N <sub>2</sub> O consumption = 0	10 s	0	1/0	1/0	1/0	1/0	1/0	1/0	1/0	1/0	1/0	I	S
Mains fail. Device running on batteries	101	Mains fail	Restore mains supply	-	1 s	0	1	1	1	1	1	1	1	1	1	I	S
Emergency dosing active	102	Active emergency dosing was recognised during the boot process	Turn off emergency dosing	> 2 lpm	-	0	1	0	0	0	0	0	0	0	0	I	S
	103	Emergency dosing released during ventilation and handwheel activated	Successful fresh gas blender check in system test			0	0	1	1	1	1	1	1	1	1	I	S
Emergency dosing still active. Please turn off emergency dosing.	104	Active emergency dosing was recognised during the boot process	Turn off emergency dosing or confirm with "Yes"	> 2 lpm	-	0	1	0	0	0	0	0	0	0	0	D	S
O <sub>2</sub> fail. Fresh gas with air.	170	O <sub>2</sub> (CGS and reserve) supply fail, air ok	Restore O <sub>2</sub> supply (CGS or reserve)	O <sub>2</sub> < 1,1 bar Reserve > = 1,1 bar	2 s	0	1/0	1/0	1/0	1/0	1/0	1/0	1/0	1/0	1/0	H	S
	172					0	1/0	1/0	1/0	1/0	1/0	1/0	1/0	1/0	1/0	H	S

Table 46: List of all alarm messages

Alarm message	No.	Description	Removal	Limit value	Filtering	0 = inactive 1 = active 1/0 = can be deactivated										Priority (Dialogue, Info, Medium, High)	Code (Patient, Technical, System)
						Self check	Standby	MAN/SPONT	IMV	S-IMV	PCV	S-PCV	PSV	HLM	MON		
Inspiratory O <sub>2</sub> high	309	Inspiratory O <sub>2</sub> too high	Change ventilation parameters		3 breaths	0	0	1	1	1	1	1	1	0	1	M	P
Inspiratory O <sub>2</sub> low	310	Inspiratory O <sub>2</sub> too low	Change ventilation parameters	(→ "Application area and increment of alarm" p. 209)	3 breaths	0	0	1	1	1	1	1	1	0	1	H	P
O <sub>2</sub> calibration necessary: Remove watertrap briefly	125	Oxygen calibration is necessary	Calibration	-	-	0	1	1	1	1	1	1	1	1	1	H	S
O <sub>2</sub> and air fail. No fresh gas.	171	O <sub>2</sub> (CGS and reserve) supply fail, Air also failed	Restore O <sub>2</sub> (CGS or reserve) and air supply	O <sub>2</sub> < 1.1 bar AIR < 1.1 bar	2 s	0	1/0	1/0	1/0	1/0	1/0	1/0	1/0	1/0	1/0	H	S
	0					1/0	1/0	1/0	1/0	1/0	1/0	1/0	1/0	1/0	H	S	
O <sub>2</sub> supply on reserve	176	O <sub>2</sub> CGS supply fail. Reserve ok	Restore O <sub>2</sub> supply CGS	PS3 > 1.1 bar PS2 < PS3 and PS2 < 2.5	10 s	0	1/0	1/0	1/0	1/0	1/0	1/0	1/0	1/0	1/0	I	S
O <sub>2</sub> supply fail	174	O <sub>2</sub> supply fail but not needed at present	Restore O <sub>2</sub> supply (CGS or reserve)	< 1.1 bar	2 s	0	1/0	1/0	1/0	1/0	1/0	1/0	1/0	1/0	1	H	S
O <sub>2</sub> CGS input pressure too high	162	O <sub>2</sub> CGS supply pressure too high	Check pressure O <sub>2</sub> CGS	> 7.5 bar	> 10 s	0	1	1	1	1	1	1	1	1	1	I	S
O <sub>2</sub> CGS supply too low	175	O <sub>2</sub> CGS supply has low input pressure but still supplies gas	Check O <sub>2</sub> supply CGS	1.1 < PS2 < 2.5 at bar O <sub>2</sub> consumption > 0 PS2 < 2.5 with O <sub>2</sub> consumption = 0	10 s	0	1/0	1/0	1/0	1/0	1/0	1/0	1/0	1/0	1/0	H	S



Table 46: List of all alarm messages

Alarm message	No.	Description	Removal	Limit value	Filtering	0 = inactive 1 = active 1/0 = can be deactivated										Priority (Dialogue, Info, Medium, High)	Code (Patient, Technical, System)
						Self check	Standby	MAN/SPONT	IMV	S-IMV	PCV	S-PCV	PSV	HLM	MON		
Patient module not locked. Ventilation stopped	111	-	Lock patient module	-	-	0	0	1/0	1/0	1/0	1/0	1/0	1/0	1/0	1/0	H	S
Patient module not locked	110	-	Lock patient module	-	-	0	1	0	0	0	0	0	0	0	0	I	S
Patientsafe: Reboot the device	55	Device cannot be operated. Ventilation continues				1	1	1	1	1	1	1	1	1	1	H	T
Paw < -10 mbar	362	Ventilation pressure < -10 mbar	Change ventilation parameters	10 mbar		0	0	1	1	1	1	1	1	0	0	H	P
Paw > alarm limit CPAP	359	Ventilation pressure > alarm limit	Change APL setting	20 mbar	-	0	0	0	0	0	0	0	0	1	1	H	P
Paw > alarm limit pPeak	304	Ventilation pressure > alarm limit	Change ventilation parameters	IMV, SIMV: mbar P <sub>max</sub> + 5 PCV, SPCV: P <sub>insp</sub> + 10 Manspont: 20	-	0	0	1/0	1	1	1	1	1	0	0	H	P
	337			IMV, SIMV: P <sub>max</sub> mbar + 10 PCV, SPCV: P <sub>insp</sub> + 10 Manspont: Adult 40 Child 35	3 breaths	0	0	1/0	1	1	1	1	1	0	0	H	P
PEEP not reached	335	The PEEP set is not reached	Change ventilation parameters	PEEP setting - 2 mbar	5 breaths	0	0	0	1	1	1	1	1	0	0	M	P

Table 46: List of all alarm messages

Alarm message	No.	Description	Removal	Limit value	Filtering	0 = inactive 1 = active 1/0 = can be deactivated										Priority (Dialogue, Info, Medium, High)	Code (Patient, Technical, System)
						Self check	Standby	MAN/SPONT	IMV	S-IMV	PCV	S-PCV	PSV	HLM	MON		
P <sub>max</sub> setting reached too early.	306	Plateau pressure reached too early	Increase P <sub>max</sub>	-	2 breaths	0	0	0	1	1	0	0	0	0	0	M	P
Primary anaesthetic gas recognised.	120	1. Anaesthetic gas discovered (previously: none)	-	-	-	0	1	1	1	1	1	1	1	1	1	I	S
	121	1. Anaesthetic gas discovered (previously: other)				0	1	1	1	1	1	1	1	1	1	1	I
Secondary anaesthetic gas discovered (MAC<3)	123	Anaesthetic gas blend recognised with MAC<3	-	-	-	0	1	1	1	1	1	1	1	1	1	I	S
Secondary anaesthetic gas recognised (MAC>3)	119	Anaesthetic gas blend recognised with MAC>3	-	-	-	0	1	1	1	1	1	1	1	1	1	I	M
Sensor fail, only MAN/SPONT possible	4	Faulty pressure sensor or not calibrated	Not possible during operation. Only resettable via reboot	+/- 5 mbar	-	0	1	1	1	1	1	1	1	1	1	H	T

Table 46: List of all alarm messages

Alarm message	No.	Description	Removal	Limit value	Filtering	0 = inactive 1 = active 1/0 = can be deactivated										Priority (Dialogue, Info, Medium, High)	Code (Patient, Technical, System)
						Self check	Standby	MAN/SPONT	IMV	S-IMV	PCV	S-PCV	PSV	HLM	MON		
Sensor fail, only MAN/SPONT possible	77	Pressure valve from drive gas blender frozen (sensor tube off or disconnected, sensor fail)	Successful compliance test in system test	-	3 breaths	0	0	1	1	1	1	1	1	1	1	H	T
	78	Pressure valve from mainboard frozen (sensor tube off or disconnected, sensor fail)				0	0	1	1	1	1	1	1	1	1	H	T
Insp. SEVO too high	320	Inspiratory sevoflurane too high	Change vaporiser setting	(→ "Application area and increment of alarm" p. 209)	3 breaths	0	0	1	1	1	1	1	0	1	H	P	
Insp. SEVO too low	321	Inspiratory sevoflurane too low				0	0	1	1	1	1	1	1	0	1	M	P

Table 46: List of all alarm messages

Alarm message	No.	Description	Removal	Limit value	Filtering	0 = inactive 1 = active 1/0 = can be deactivated										Priority (Dialogue, Info, Medium, High)	Code (Patient, Technical, System)
						Self check	Standby	MAN/SPONT	IMV	S-IMV	PCV	S-PCV	PSV	HLM	MON		
Technical failure	7	If the error is not fixed by a restart or it is repeated, make a note of the error number and notify a service technician authorised by Löwenstein Medical	Not possible during operation. Only resettable via reboot. Use the O <sub>2</sub> emergency dosing	-	-	1	0	0	0	0	0	0	0	0	0	H	T
	8					1	0	0	0	0	0	0	0	0	H	T	
	9					1	1	1	1	1	1	1	1	1	H	T	
	10					1	1	1	1	1	1	1	1	1	H	T	
	11					1	1	1	1	1	1	1	1	1	H	T	
	12					1	1	1	1	1	1	1	1	1	H	T	
	13					0	1	1	1	1	1	1	1	1	H	T	
	15					1	0	0	0	0	0	0	0	0	H	T	
	16					0	1	1	1	1	1	1	1	1	H	T	
	17					0	1	1	1	1	1	1	1	1	H	T	
	20					0	1	1	1	1	1	1	1	1	H	T	
	21					1	0	0	0	0	0	0	0	0	1	H	T

Table 46: List of all alarm messages

Alarm message	No.	Description	Removal	Limit value	Filtering	0 = inactive 1 = active 1/0 = can be deactivated										Priority (Dialogue, Info, Medium, High)	Code (Patient, Technical, System)	
						Self check	Standby	MAN/SPONT	IMV	S-IMV	PCV	S-PCV	PSV	HLM	MON			
Technical failure	22	If the error is not fixed by a restart or it is repeated, make a note of the error number and notify a service technician authorised by Löwenstein Medical	Not possible during operation. Only resettable via reboot. Use the O <sub>2</sub> emergency dosing	-	-	1	1	1	1	1	1	1	1	1	1	H	T	
	23					1	0	0	0	0	0	0	0	0	0	H	T	
	30		Replace/repair use the O <sub>2</sub> emergency dosing			1	1	1	1	1	1	1	1	1	1	1	H	T
	31					1	1	1	1	1	1	1	1	1	1	1	H	T
	32					1	1	1	1	1	1	1	1	1	1	1	H	T
	33					1	1	1	1	1	1	1	1	1	1	1	H	T
	34					1	1	1	1	1	1	1	1	1	1	1	H	T
	35					1	1	1	1	1	1	1	1	1	1	1	H	T
	36					1	1	1	1	1	1	1	1	1	1	1	H	T
	37					1	1	1	1	1	1	1	1	1	1	1	H	T
	44					0	1	1	1	1	1	1	1	1	1	1	1	H

Table 46: List of all alarm messages

Alarm message	No.	Description	Removal	Limit value	Filtering	0 = inactive 1 = active 1/0 = can be deactivated										Priority (Dialogue, Info, Medium, High)	Code (Patient, Technical, System)		
						Self check	Standby	MAN/SPONT	IMV	S-IMV	PCV	S-PCV	PSV	HLM	MON				
Technical failure	46	If the error is not fixed by a restart or it is repeated, make a note of the error number and notify a service technician authorised by Löwenstein Medical	Replace/repair use the O <sub>2</sub> emergency dosing	-	-	1	1	1	1	1	1	1	1	1	1	H	T		
	47					1	1	1	1	1	1	1	1	1	H	T			
	60					0	0	1	1	1	1	1	1	1	H	T			
	61					1	0	0	0	0	1	0	0	0	H	T			
	62					1	1	1	1	1	1	1	1	1	H	T			
	63					1	1	1	1	1	1	1	1	1	1	H	T		
Drive gas switched to Air	167	O <sub>2</sub> supply CGS fail. Switching to air	Restore O <sub>2</sub> supply CGS	-	2 s	0	1/0	1/0	1/0	1/0	1/0	1/0	1/0	1/0	1/0	1/0	1/0	I	S
Drive gas switched to O <sub>2</sub>	168	Air supply failed. Switching to O <sub>2</sub>	Restore air supply CGS	-	2 s	0	1/0	1/0	1/0	1/0	1/0	1/0	1/0	1/0	1/0	1/0	1/0	I	S
Versions not compatible.	40	VersionsCheck shows incompatibility	Replace / repair	-	-	1	1	1	1	1	1	1	1	1	1	1	H	T	
V <sub>T</sub> e low	332	Tidal volume too low	Change ventilation parameters	(→ "Application area and increment of alarm" p. 209)	3 breaths	0	0	1/0	1	1	1	1	1	0	0	M	P		
VueLink not connected	192	VueLink is not connected/incorrectly connected	Received valid requests/ VueLink deactivated	-	60 s	0	1	1	1	1	1	1	1	1	1	I	S		
Change watertrap gas measurement	129	Watertrap blocked or full	Change watertrap	-	-	0	1	1	1	1	1	1	1	1	1	M	S		

## 12. Errors and measures

### General information

#### **Patient monitoring**

---



*System and technical errors have error numbers. System errors can generally be fixed by the user. To fix a technical error, you should refer to a Löwenstein Medical-authorized service technician.*

## Pressure relief valve

Table 47: Pressure relief valve

Valve (short description) (→ "Gas flow plans" p. 292)	Description	Maximum work pressure [Pa × 100] (mbar)	Driving	Status of malfunction
APL (APL)	Control of the airway pressure in the MAN/SPONT, HLM and MON forms of ventilation.	90 (without rapid venting)  80 (with rapid venting)	manual	manually adjustable
PEEP valve (VC2)	Control of the airway pressure in mechanical ventilation	125	electric	open without current
plateau valve (VC1)	Production of an inspiratory plateau during mechanical ventilation	125	electric	open without current
Excess diaphragm (PV)	Excess fresh gas leaks	2	pneumatic	open without pressure

The electrically controlled valves are opened when the device is shut down (without power). In the accessed state an airway pressure of a maximum of 125 Pa × 100 (mbar) can be produced, depending on the build (through power limitation).

In the MAN/SPONT, HLM and MON forms of ventilation the control of the airway pressure is carried out purely through the APL. During mechanical ventilation, the APL is decoupled. Excess fresh gas leaks through the excess diaphragm. If the valves malfunction, pressures that could endanger the patient can leak through the plateau and PEEP valve.



## Defined safe state

In the *leon plus*, the ventilation unit, user interface and monitoring system are separate, independent modules. Two safe states are defined:

- **Patientsafe:** If the user interface with monitoring fails, the ventilation unit continues to run.
- **Failsafe:** If the ventilation unit and user interface with monitoring fail, manual ventilation is possible with the *leon plus*.

For a defined safe state it is required that the *leon plus* can no longer be operated in its proper state.

Depending on the extent of the failure, the *leon plus* then automatically goes into one of two defined safe states.

If the user deliberately shuts down manually, these states can be left. Manual ventilation is possible with *leon plus* in deactivated state.

(→ "Power off" p. 138)

## Patientsafe defined safe state

---

- the device can no longer be operated with the touchscreen and keyboard (other than to turn off)
- **ventilation continues with the last ventilation parameters set**
- fresh gas supply is carried out according to the last settings of the fresh gas blender
- AIR, N<sub>2</sub>O are available
- O<sub>2</sub> flush is available
- anaesthetic vaporiser available

### Failsafe defined safe state

- the device can no longer be operated with the touchscreen and keyboard (other than to turn off)
- ventilation and gas monitoring are not possible
- all electric valves are without power
- all pneumatic valves are without pressure
- **the mechanical ventilation is stopped, the patient must be manually ventilated with the *leon plus***
- fresh gas is supplies in accordance with the O<sub>2</sub>emergency dose settings
- O<sub>2</sub> flush is available
- anaesthetic vaporisers available

## Inoperability or failure of the device

### Reaction of the system and measures in the event of inoperability of the device (Patientsafe)

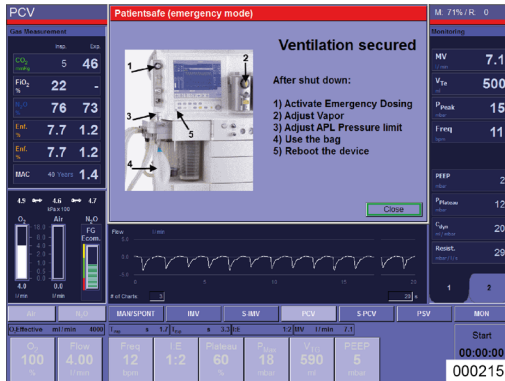

#### Messages/measures (Patientsafe (emergency operation)):

After shutdown:

- 1) open emergency dosing
- 2) adjust vapour settings
- 3) set APL
- 4) use manual ventilation
- 5) restart device

**The device should be restarted as soon as possible.**

**Points 1) and 5) must be carried out after shutdown.**

💡 *The device switches to the defined safe state Patientsafe. A change of parameters is not possible without restarting the device. The ventilation continues with the last fresh gas settings and ventilation parameters set.*

💡 *The O<sub>2</sub> emergency dosing is released.*

**Closes the Patientsafe error dialogue (emergency operation).**

💡 *Ventilation continues with the last fresh gas settings and ventilation parameters set. The O<sub>2</sub> emergency dosing is released.*

💡 (→ "Execute quick start" p. 150)

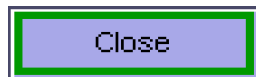

## Reaction of the system and measures in the event of failure of the device (Failsafe)

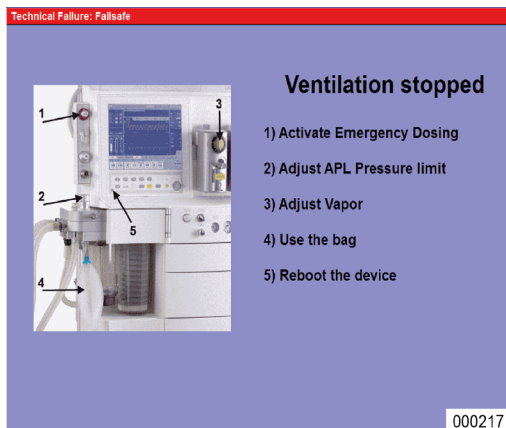

### Messages/measures (technical errors: Failsafe):

- 1) open emergency dosing
- 2) set APL
- 3) adjust vapour settings
- 4) use manual ventilation
- 5) restart device

### Points 1) and 5) must be carried out immediately.

The device switches to the defined safe state Failsafe. A change of parameters is not possible without restarting the device.

The patient must be ventilated manually with the *leon plus*.

Fresh gas is supplied in accordance with the O<sub>2</sub> emergency dose settings.

See also manual ventilation presentation

(→ "Start a MAN/SPONT manual/spontaneous ventilation" p. 151).

If the device cannot be turned off in the normal way (after pressing the ON/OFF button on the keypad, the screen does not go dark even after a fairly long time), keep the ON/OFF button pressed down for approx. 40 seconds.

Depending on the SW version, the device reacts as follows:

#### Earlier than SW version 3.5.24, 3.10.8, 3.11.7

- The device switches off

#### Later than SW version 3.5.25, 3.10.9, 3.11.9

1. Release the ON/OFF button.
2. Go to the rear of the device within 30 seconds and pull the mains plug.  
The device switches off.
3. Reinsert the mains plug.  
The device can be started normally.



### WARNING

---

Failure of the device

#### Death or permanent injury of the patient

- Use an alternative ventilation system
  - Use an external gas monitor
  - Check for a possible alternative continuation of the anaesthetic gas
- 

If you are unable to fix the error yourself, notify a Löwenstein Medical-authorized technician.

(→ "Execute quick start" p. 150)

Self check error search

**Gas supply error search**

Table 48: Gas supply error messages

Test	Error message	Description	Possible cause
AIR	Traffic light is red	/	<ul style="list-style-type: none"> <li>▪ CGS not attached</li> <li>▪ CGS pressure too low</li> </ul>
O <sub>2</sub>			<ul style="list-style-type: none"> <li>▪ CGS not attached</li> <li>▪ CGS pressure too low</li> </ul>
N <sub>2</sub> O			<ul style="list-style-type: none"> <li>▪ CGS not attached</li> <li>▪ CGS pressure too low</li> </ul>

**Self check error search**

Table 49: Self check error messages

Test	Error message	Description	Possible cause
Loudspeaker	Traffic light is red	/	<ul style="list-style-type: none"> <li>▪ damaged</li> <li>▪ cabling damaged</li> </ul>
Battery	Traffic light is red		<ul style="list-style-type: none"> <li>▪ damaged</li> <li>▪ cabling damaged</li> </ul>
	Traffic light is yellow		<ul style="list-style-type: none"> <li>▪ battery voltage low</li> </ul>
Gas measurement	Traffic light is red	<ul style="list-style-type: none"> <li>▪ damaged</li> <li>▪ cabling damaged</li> <li>▪ tubing damaged</li> </ul>	

## Error search system test

## Error search gas type check

Table 50: Gas type check

Test	Error message	Description	Possible cause
N <sub>2</sub> O check	N <sub>2</sub> O check: Not executed due to previous error	Error from previous test not fixed	/
	N <sub>2</sub> O check: No N <sub>2</sub> O detected	Oxygen concentration not < 10% if nitrous oxide flows	<ul style="list-style-type: none"> <li>N<sub>2</sub>O incorrectly connected</li> </ul>
	N <sub>2</sub> O check:N <sub>2</sub> O input pressure outside of permitted range	CGS pressure too high or too low	<ul style="list-style-type: none"> <li>check N<sub>2</sub>O CGS wall connection</li> </ul>
	N <sub>2</sub> O check:O <sub>2</sub> input pressure outside of permitted range	CGS pressure too high or too low	<ul style="list-style-type: none"> <li>check O<sub>2</sub> CGS wall connection</li> </ul>
	N <sub>2</sub> O check: N <sub>2</sub> O and O <sub>2</sub> input pressure outside of permitted range	CGS pressure too high or too low	<ul style="list-style-type: none"> <li>check N<sub>2</sub>O and O<sub>2</sub> CGS wall connection</li> </ul>
O <sub>2</sub> check	O <sub>2</sub> check: No O <sub>2</sub> detected	Oxygen concentration not > 35% if oxygen flows	<ul style="list-style-type: none"> <li>O<sub>2</sub> incorrectly connected</li> </ul>
	O <sub>2</sub> check:O <sub>2</sub> input pressure outside of permitted range	CGS pressure too high or too low	<ul style="list-style-type: none"> <li>check O<sub>2</sub> CGS wall connection</li> </ul>
AIR check	AIR check: No AIR detected	Oxygen concentration > 35% or < 10% if AIR flows	<ul style="list-style-type: none"> <li>AIR incorrectly connected</li> </ul>
	AIR check: AIR input pressure outside of permissible range	CGS pressure too high or too low	<ul style="list-style-type: none"> <li>check AIR CGS wall connection</li> </ul>

**Error search fresh gas blender**

Table 51: Error messages fresh gas blender

Test	Error message	Description	Possible cause
Calibration O <sub>2</sub> cell fresh gas blender 21% or 100%	Not executed due to previous error	Error from previous test not fixed	/
	O <sub>2</sub> calibration: AIR and O <sub>2</sub> not available	no O <sub>2</sub> and AIR detected in gas type check	<ul style="list-style-type: none"> <li>▪ O<sub>2</sub> and AIR incorrectly connected</li> </ul>
	O <sub>2</sub> calibration: System under pressure	Pressure during oxygen calibration > 4 mbar	<ul style="list-style-type: none"> <li>▪ fresh gas blender untight</li> </ul>
	O <sub>2</sub> calibration: O <sub>2</sub> cell soon exhausted	at calibration 21% and 100% value too low (yellow traffic light)	<ul style="list-style-type: none"> <li>▪ O<sub>2</sub> cell soon exhausted</li> </ul>
	O <sub>2</sub> calibration: Signal too low	at calibration 21% or 100% value considerably too low	<ul style="list-style-type: none"> <li>▪ O<sub>2</sub> cell fail</li> <li>▪ no O<sub>2</sub> detected</li> </ul>
	O <sub>2</sub> calibration: Signal too high	at calibration 21% or 100% value considerably too high	<ul style="list-style-type: none"> <li>▪ O<sub>2</sub> cell fail</li> <li>▪ fresh gas blender untight</li> </ul>
	O <sub>2</sub> calibration: Data not stable	Signal not stable	<ul style="list-style-type: none"> <li>▪ O<sub>2</sub> cell fail</li> </ul>

Table 51: Error messages fresh gas blender

Test	Error message	Description	Possible cause
O <sub>2</sub> check	Fresh gas blender: O <sub>2</sub> not available	no O <sub>2</sub> detected in gas type check	<ul style="list-style-type: none"> <li>▪ O<sub>2</sub> incorrectly connected</li> </ul>
	Fresh gas blender: Flow out of permissible range	Flow of a valve out of permissible range or obstruction	<ul style="list-style-type: none"> <li>▪ valve fresh gas blender fail</li> <li>▪ O<sub>2</sub> emergency dosing untight</li> <li>▪ CGS not connected or pressure too low</li> <li>▪ occlusion in the fresh gas branch</li> </ul>
Check AIR, N <sub>2</sub> O	Fresh gas blender: AIR and N <sub>2</sub> O not available	no AIR, N <sub>2</sub> O detected in gas type check	<ul style="list-style-type: none"> <li>▪ N<sub>2</sub>O, AIR incorrectly connected</li> </ul>
	Fresh gas blender: Flow out of permissible range	Flow of a valve out of permissible range or obstruction	<ul style="list-style-type: none"> <li>▪ valve fresh gas blender fail</li> <li>▪ O<sub>2</sub> emergency dosing untight</li> <li>▪ CGS not connected or pressure too low</li> <li>▪ occlusion in the fresh gas branch</li> </ul>



**Error search respirator**

Table 52: Error messages respirator

Test	Error message	Description	Possible cause
Drive gas blender	Drive gas blender: not executed due to previous error	Error from previous test not fixed	/
	Drive gas blender: Flow out of permissible range	Drive gas flow of a valve out of range or obstruction	<ul style="list-style-type: none"> <li>▪ emergency air valve untight</li> <li>▪ insp. flow sensor untight</li> <li>▪ insp. flow sensor fail</li> <li>▪ valve drive gas generator fail</li> <li>▪ plateau valve fail</li> <li>▪ decoupling diaphragm untight</li> <li>▪ insp. inspection glass untight</li> <li>▪ O-Ring on the drive gas port failed or defective</li> <li>▪ patient module not locked</li> <li>▪ dome not correctly adapted</li> <li>▪ CGS not attached</li> <li>▪ vaporiser</li> <li>▪ PEEP valve malfunction. PEEP diaphragms</li> </ul>
	Drive gas blender: insp./exp. differ	different insp. and exsp. flow, leak	<ul style="list-style-type: none"> <li>▪ flow sensor, insp., exp. fail</li> <li>▪ y-piece not on the test adapter</li> </ul>
	Drive gas blender: Pressure too high	Blockage	<ul style="list-style-type: none"> <li>▪ high resistance after insp. flow sensor</li> <li>▪ PEEP valve hangs</li> </ul>
	Drive gas blender: AIR, O <sub>2</sub> not available (only with leon <i>plus</i> )	Drive gas blender: AIR, O <sub>2</sub> not available	<ul style="list-style-type: none"> <li>▪ O<sub>2</sub> and/or AIR erroneously or not connected</li> </ul>

**Error search flow sensors**

Table 53: Error messages flow measurement

Test	Error message	Description	Possible cause
Flow calibration	Flow not 0	a flow was detected during calibration	<ul style="list-style-type: none"> <li>▪ fresh gas blender untight</li> <li>▪ flow sensor fail</li> </ul>
	Disconnected	/	<ul style="list-style-type: none"> <li>▪ plug or cabling to the flow sensor fail</li> </ul>
	Contaminated (insp. wire)	/	<ul style="list-style-type: none"> <li>▪ Flow sensor contaminated (insp.)</li> </ul>
	Sensor contaminated (exp. wire)	/	<ul style="list-style-type: none"> <li>▪ Flow sensor contaminated (exp.)</li> </ul>
	Failed (insp. wire)	/	<ul style="list-style-type: none"> <li>▪ Flow sensor fail (insp.)</li> </ul>
	Failed (exp. wire)	/	<ul style="list-style-type: none"> <li>▪ Flow sensor fail (exp.)</li> </ul>

**Error search circulation system**

Table 54: Error messages circulation system

Test	Error message	Description	Possible cause
Tube system	Compl.:not executed due to previous error	Error from previous test not fixed	/
	Compl.:pressure not reached	heavy leak	<ul style="list-style-type: none"> <li>▪ emergency air valve untight</li> <li>▪ flow sensor untight</li> <li>▪ ventilation tubes untight</li> <li>▪ exp. inspection glass untight</li> <li>▪ patient module not locked</li> <li>▪ dome not correctly adapted</li> <li>▪ dome seal not correctly fitted or damaged</li> <li>▪ gas measurement cable not connected (only with gas meter)</li> <li>▪ y-piece not on the test adapter</li> <li>▪ PEEP valve untight</li> <li>▪ decoupling diaphragm untight</li> </ul>
	Compl.:leak too big	/	
	Compl.:pressure rise on zero flow	Pressure rise although flow turned off	<ul style="list-style-type: none"> <li>▪ drive gas blender untight</li> <li>▪ slide valve auto/manual untight</li> </ul>
	Compl.:compliance too low/high	Compliance too high	<ul style="list-style-type: none"> <li>▪ inspiration shank occluded</li> </ul>
	Compl.:inspiratory non-return valve untight	blue inspiratory valve diaphragm untight	<ul style="list-style-type: none"> <li>▪ blue insp. valve diaphragm, not available, damaged, fits incorrectly</li> </ul>
	Compl.:insp. Valve: Pressure not reached	blue inspiratory valve diaphragm untight	<ul style="list-style-type: none"> <li>▪ blue insp. valve diaphragm, not available, damaged, fits incorrectly</li> </ul>

Table 54: Error messages circulation system

Test	Error message	Description	Possible cause
	Compl.:drive gas blender not available	/	See error search respirator
	Compl.:drive gas not available (only with the leon <i>plus</i> )	no AIR, O <sub>2</sub> recognised	O <sub>2</sub> and/or AIR incorrectly connected or not connected
Complete system	Compl.:not executed due to previous error	Error from previous test not fixed	/
	Leak:filling the bag not possible		<ul style="list-style-type: none"> <li>▪ bag no longer suitable, change</li> </ul>
	Compl.:pressure not reached	heavy leak	<ul style="list-style-type: none"> <li>▪ ventilation bag/tube to bag leaking</li> </ul>
	Compl.:leak too big	/	<ul style="list-style-type: none"> <li>▪ Plateau valve untight</li> <li>▪ CO<sub>2</sub> absorber untight or not properly adapted</li> <li>▪ excess diaphragm untight</li> <li>▪ APL untight</li> <li>▪ O-ring on the slide valve auto/manual damaged</li> </ul>
	Compl.:pressure rise on zero flow	Pressure rise although flow turned off	<ul style="list-style-type: none"> <li>▪ fresh gas blender untight</li> <li>▪ pressure port on the excess diaphragm untight</li> <li>▪ slide valve APL</li> </ul>

Table 54: Error messages circulation system

Test	Error message	Description	Possible cause
APL	Leak, APL:start pressure not reached	Leak, inlet pressure, bag filling not reached	<ul style="list-style-type: none"> <li>see error search circulation system/complete system/<b>Compl.:pressure not reached</b></li> </ul>
	Leak, APL:end pressure not reached	Leak, pressure > 20 mbar not reached	<ul style="list-style-type: none"> <li>see error search circulation system/complete system/<b>Compl.:pressure not reached</b></li> <li>APL not set to 20 mbar</li> <li>Vaporiser or vaporiser bracket leaking</li> </ul>
	Leak, APL:check valve	APL too tight or untight	<ul style="list-style-type: none"> <li>APL defective</li> <li>slide valve auto/manual</li> <li>Manual ventilation bag too old</li> <li>leak complete system too big</li> <li>vapour or vapour suspension bracket untight</li> </ul>
Bellows	Leak, bellows:minimum flow not reached	Bellows does not move up	<ul style="list-style-type: none"> <li>drive gas blender fail</li> <li>insp. flow sensor fail</li> <li>dome untight or not properly screwed on</li> <li>O-ring dome carrier damaged or failed</li> </ul>
	Leak, bellows:not available	Bellows not recognised	<ul style="list-style-type: none"> <li>Bellows not available or dropped off</li> </ul>

**Error search FiO<sub>2</sub> calibration**Table 55: Error messages O<sub>2</sub> calibration

Test	Error message	Description	Possible cause
Calibration	O <sub>2</sub> calibration:not executed due to previous error	Error from previous test not fixed	/
	O <sub>2</sub> calibration: O <sub>2</sub> cell soon exhausted	at calibration 21% and 100% value too low (yellow traffic light)	▪ O <sub>2</sub> cell soon exhausted
	O <sub>2</sub> calibration:signal too low	at calibration 21% and 100% value considerably too low	▪ O <sub>2</sub> cell fail
	O <sub>2</sub> calibration:signal too high	at calibration 21% and 100% value considerably too high	▪ O <sub>2</sub> cell fail
	O <sub>2</sub> calibration.:data not stable	Signal not stable	▪ O <sub>2</sub> cell fail

(only for option "external O<sub>2</sub> fuel cells")

External supply units failure

**No central gas supply**

 We recommend that O<sub>2</sub> and N<sub>2</sub>O reserve gas bottles are kept available connected to the device.

If the pressure of the central gas supply falls below  $2.3 \pm 0.3 \text{ kPa} \times 100 \text{ (bar)}$ , this is judged by the system as a failure of the gas supply and it switches to reserve gas bottle operation. Depending on whether reserve gas bottles are attached and whether they are filled, the system reacts according to the following table:

**Reaction of the system when no central gas supply**

Table 56: Gas supply when CGS fails

CGS			Reserve		O <sub>2</sub> concentration if carrier gas is:		Drive gas	Possible messages (see following table)
AIR	O <sub>2</sub>	N <sub>2</sub> O	O <sub>2</sub>	N <sub>2</sub> O	AIR	N <sub>2</sub> O		
OK	OK	OK	closed	closed	Blender setting	Blender setting	AIR	None
OK	OK	<b>failed</b>	closed	open	Blender setting	Blender setting	AIR	3.2, 3.3
OK	OK	<b>failed</b>	closed	empty	Blender setting	100%	AIR	3.2, 3.3
<b>failed</b>	OK	OK	closed	closed	100%	Blender setting	O <sub>2</sub>	1.1, 1.2
<b>failed</b>	OK	<b>failed</b>	closed	closed	100%		O <sub>2</sub>	3.4
OK	<b>failed</b>	OK	closed	closed	Blender setting	Blender setting	AIR	2.1
OK	<b>failed</b>	OK	open	closed	Blender setting	Blender setting	AIR	2.2
OK	<b>failed</b>	OK	empty	closed	21% (AIR)		AIR	2.2, 2.3

Table 56: Gas supply when CGS fails

CGS			Reserve		O <sub>2</sub> concentration if carrier gas is:		Drive gas	Possible messages (see following table)
AIR	O <sub>2</sub>	N <sub>2</sub> O	O <sub>2</sub>	N <sub>2</sub> O	AIR	N <sub>2</sub> O		
OK	<b>failed</b>	<b>failed</b>	open	open	Blenders etting	Blender setting	AIR	2.2, 3.2
OK	<b>failed</b>	<b>failed</b>	open	empty	Blender setting	100%	AIR	2.2, 3.2
OK	<b>failed</b>	<b>failed</b>	empty	open	21% (AIR)		AIR	2.2, 2.3, 3.2
OK	<b>failed</b>	<b>failed</b>	empty	empty	21% (AIR)		AIR	2.2, 2.3, 3.2
<b>failed</b>	<b>failed</b>	OK	closed	closed	operation not possible		operation not possible	4
<b>failed</b>	<b>failed</b>	OK	open	closed	100%	Blender setting	mechanical ventilation not possible	1.2, 2.2
<b>failed</b>	<b>failed</b>	OK	empty	closed	operation not possible		operation not possible	4
<b>failed</b>	<b>failed</b>	<b>failed</b>	open	open	100%	Blender setting	mechanical ventilation not possible	1.2, 2.2, 3.2
<b>failed</b>	<b>failed</b>	<b>failed</b>	open	empty	100%		mechanical ventilation not possible	2, 3.2
<b>failed</b>	<b>failed</b>	<b>failed</b>	empty	open	operation not possible		operation not possible	4, 3.2
<b>failed</b>	<b>failed</b>	<b>failed</b>	empty	empty	operation not possible		operation not possible	4



Table 57: Possible messages

1.1	Drive gas switched to O <sub>2</sub>
1.2	AIR failed. Fresh gas 100% O <sub>2</sub> (only with the leon <i>plus</i> )
2.1	O <sub>2</sub> supply fail
2.2	O <sub>2</sub> fail. Fresh gas on AIR (only with the leon <i>plus</i> )
2.3	O <sub>2</sub> supply on reserve
2.4	Drive gas switched to AIR
3.1	N <sub>2</sub> O supply fail
3.2	N <sub>2</sub> O supply on reserve
3.3	N <sub>2</sub> O fail. Fresh gas 100% O <sub>2</sub> (only with the leon <i>plus</i> )
3.4	Air and N <sub>2</sub> O failed. Fresh gas 100% O <sub>2</sub> (only with the leon <i>plus</i> )
4	O <sub>2</sub> and AIR failed. Fresh gas stopped (only with the leon <i>plus</i> )



**WARNING**

Failure of the device

**Death or permanent injury of the patient**

- Use an alternative ventilation system
- Use an external gas monitor
- Check for a possible alternative continuation of the anaesthetic gas



**WARNING**

Failure of the device

**Death or permanent injury of the patient**

Only if the following errors occur at the same time should the leon *plus* no longer be operated: O<sub>2</sub> supply pressure of the CGS failed, O<sub>2</sub> reserve gas bottles not available or empty and AIR supply pressure of the CGS failed



*A mechanical ventilation is only possible with a pressure air supply through O<sub>2</sub> or AIR of the CGS, or through O<sub>2</sub> or AIR from the 10 L bottle. Otherwise the system switches automatically to the MAN/SPONT form of ventilation and the patient can continue to be ventilated with the ventilation bag.*

*The buttons to select the forms of ventilation are inactive.*

### Measures when no central gas supply

1. Open the reserve gas bottles on the rear of the device.
2. If you are unable to fix the error yourself, make a note of the error number and notify a Löwenstein Medical-authorized technician.

### Mains supply failure



- Possible messages:
  - Mains supply failure. Device running on batteries
- automatic switch-over to battery operation
- the yellow LED under the battery icon on the keyboard lit
- the green LED goes off (mains voltage available)

If the batteries are fully charged, a calculated running time of a further 100 minutes is available. However, the device only switches off automatically when the battery voltage falls below 22.1 V.

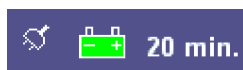

On the right of the title bar the plug icon appears in white as “No mains voltage available”, the battery icon appears in green with the display of the remaining life of the battery in minutes.



If the mains supply cannot be restored, when there is a remaining life of 10 minutes the following message appears:

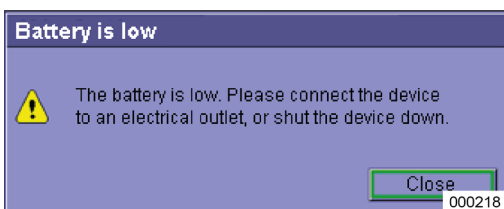

- The remaining life of the battery is short. Please connect the device to an external power supply or turn it off.



Shortly before the battery voltage falls below 22.1 V, meaning the batteries can no longer guarantee power supply, and the *leon plus* shuts down automatically, the dialogue occurs:

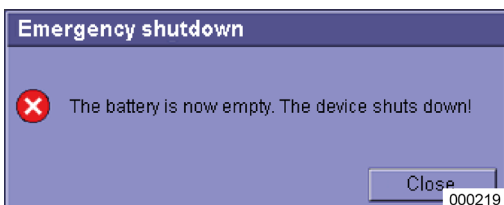

- The battery is now empty. The device shuts down.



Finally, the dialogue appears:

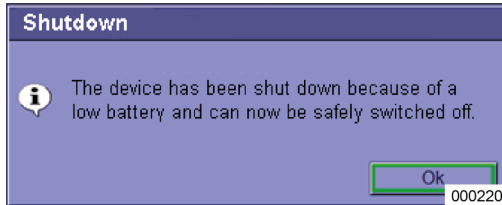

- Due to the weak battery voltage, the device has been shut down to a defined secured state and can now be switched off.

In this defined secured state and in the switched-off state, the following conditions apply:

- Manual ventilation with *leon plus* is possible.
- Fresh gas is supplied in accordance with the O<sub>2</sub> emergency dose settings.
- O<sub>2</sub> flush is available.
- Anaesthetic vaporisers are available.



---

Mains supply failure!

#### **Automatic switch-over to battery operation**

The following units are no longer supplied with voltage:

- auxiliary outlets on the rear of the device
- heating of the patient module
- workstation light

---

#### **Measures for mains supply failure**

With full batteries, all functions of the *leon plus* are available without restriction for a further 100 minutes.

If you are unable to fix the error yourself, make a note of the error number and notify a technician authorised by Löwenstein Medical.

💡 *If the device reports "Mains failure. Device running on batteries" also check the fuses of the cold device plug of the *leon plus*.*

💡 *The batteries should be replaced by a service technician authorised by Löwenstein Medical.*

## Failure of the anaesthesia gas scavenging system

### Reaction of the system when the AGSS fails

As the output of the patient module to the AGSS from the device is not monitored, a failure is not noticed and not reported. The monitoring must be guaranteed through the implementation of a suitable AGSS with display of the suction performance.

### Measures for AGSS failure

- Check whether the tubes of the AGSS are kinked or have dropped off.
- Check whether the suction performance on the AGSS is sufficient.
- Check whether the suction system is functioning (green mark on the supply plug).
- If you are unable to fix it yourself, notify your technical department or the AGSS manufacturer.



*Remember that N<sub>2</sub>O and volatile narcotics get into the ambient air and could impair your consciousness. Please also refer to the AGSS user manual.*

## Failure of internal units

### **Touchscreen failure**

---

#### **Reaction of the system to failure of the touchscreen**

If the touchscreen fails, any device function can also be accessed and carried out using the keypad buttons and the rotary switch. This guarantees that safe operation is always possible.

#### **Measures for touchscreen failure**

Operate the device via the buttons on the keyboard and the rotary button. These operating processes are described in the relevant chapters. You are now in the right column of the particular table.

## Fresh gas dosing failure

### Fresh gas blender failure

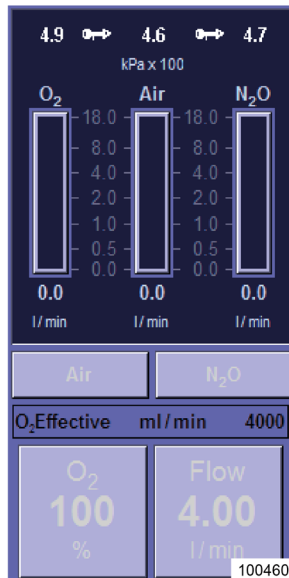

#### Reaction of the system to failure of the fresh gas blender

Possible messages:

- Blender failed. Turn on emergency dosing!
- Blender failed. Fresh gas with 100% O<sub>2</sub>

audible and visual alarm

The current form of ventilation remains active.

The fresh gas blender window becomes inactive.

💡 *The button on the keyboard for focusing the fresh gas blender window is inactive.*

#### Measures for fresh gas blender failure

Appears with message: **Blender failed. Turn on emergency dosing!**

1. Set the O<sub>2</sub> emergency dosing to the desired fresh gas flow.
2. Check the anaesthetic vaporiser setting, as the fresh flow has changed.
3. Bring the anaesthesia to an end.

Appears with message: **Blender failed. Fresh gas with 100% O<sub>2</sub>**

1. Execute a system test at the next available opportunity.
2. Check the O<sub>2</sub> gas supply.
3. Notify your technical department or the CGS manufacturer.

💡 *If you are unable to fix the error yourself, make a note of the error number and notify a technician authorised by Löwenstein Medical.*

### Failure of monitoring of fresh gas blender

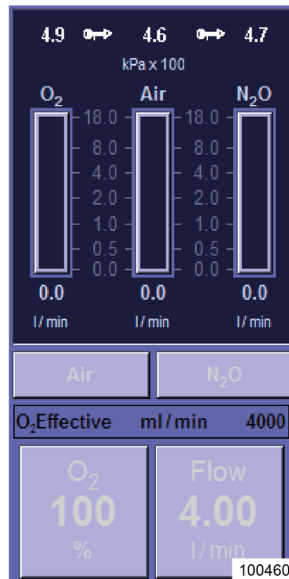

#### Reaction of the system to failure of the fresh gas blender monitoring

Possible messages:

- failure blender fresh gas 100% O<sub>2</sub>
- No N<sub>2</sub>O recognised in system test

audible and visual alarm

The current form of ventilation remains active.

#### Measures for monitoring of fresh gas blender failure

Appears with message: **failure blender fresh gas 100% O<sub>2</sub>**

1. Execute a system test at the next available opportunity.

Appears with message: **No N<sub>2</sub>O detected in system test**

1. Check the O<sub>2</sub> gas supply.
2. Notify your technical department or the CGS manufacturer.



*If you are unable to fix the error yourself, make a note of the error number and notify a technician authorised by Löwenstein Medical.*

## Ventilator failure

---

### Reaction of the system to failure of the ventilator

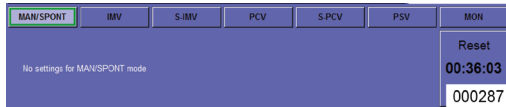

- Possible messages:
  - No driving gas. Only MAN/SPONT possible
- The system switches automatically to the MAN/SPONT form of ventilation
- The buttons to select mechanical forms of ventilation are inactive.
- audible and visual alarm
- semi-open operation is not possible.

### Measures for ventilator failure

The patient can continue to be ventilated with the ventilation bag.



*If you are unable to fix the error yourself, make a note of the error number and notify a Löwenstein Medical-authorized technician.*



## Gas measurement failed

---

### Reaction of the system to failure of the gas measurement

Possible messages:

- Gas measurement failed
- O<sub>2</sub> calibration needed: Remove water trap briefly
- Gas measurement tube occlusion
- Change gas measurement water trap

 *audible and visual alarm*

### Measures for gas measurement failure

 *The functioning of the device is not impaired.*

Gas measurement failed:

- Connect an external gas monitor to monitor the:
  - O<sub>2</sub> concentration
  - anaesthesia gas concentration
  - CO<sub>2</sub> concentration

O<sub>2</sub> calibration needed: Remove watertrap briefly:

- Remove the watertrap briefly and put it back on to force a calibration.

Gas measurement occlusion:

- Check whether the sample line is kinked or jammed.
- **LM Watertrap:** If necessary, change the watertrap with sample line  
**DRYLINE™ watertrap:** If necessary, change the sample line

Changing the watertrap sample line:

- Empty the watertrap (→ "Gas measurement maintenance (sidestream measurement)" p. 263).
- If necessary, change the watertrap.

 *If you are unable to fix the error yourself, make a note of the error number and notify a technician authorised by Löwenstein Medical.*

## Flow measurement failure

### Reaction of the system to failure of the inspiratory flow measurement

MAN/SPONT	IMV	S-IMV	PCV	S-PCV	PSV	MON
1.0	2.0	1.2	1.4			Reset 00:36:03 000288
Freq 20 bpm	I:E 1:2	Plateau 60 %	P <sub>max</sub> 50 mbar	V <sub>TG</sub> 720 ml	PEEP 5 mbar	

- Possible messages:
  - Insp. volume measurement is no longer possible
- the device continues to ventilate in the current ventilation mode
- Audible and visual alarm
- only the buttons to select the MAN/SPONT and PCV forms of ventilation are still active

### Measures for failure of the inspiratory flow measurement

Switch to the pressure-controlled PCV form of ventilation or ventilate the patient with the ventilation bag.

- No inspiratory volume measurement possible: Check the inspiratory flow sensor for soiling and damage at the next available opportunity. If necessary, change the inspiratory flow sensor.
- Execute a system test at the next available opportunity.

 *If you are unable to fix the error yourself, make a note of the error number and notify a Löwenstein Medical-authorized technician.*

### Reaction of the system to failure of the expiratory flow measurement

- Possible messages:
  - Exp. volume measurement no longer possible
- The device continues to ventilate in the current ventilation mode
- Audible and visual alarm

### Measures for failure of the expiratory flow measurement

The device continues to ventilate in the current ventilation mode (no display for MV and  $V_{Te}$ , only inspiratory flow and volume curve).

- Check the expiratory flow sensor for soiling and damage at the next available opportunity. If necessary, change the expiratory flow sensor.
- Execute a system test at the next available opportunity.



*If you are unable to fix the error yourself, make a note of the error number and notify a Löwenstein Medical-authorized technician.*

### Pressure measurement failure

---

#### Reaction of the system to failure of the pressure measurement

- Possible messages:
  - Sensor fail, only MAN/SPONT possible
- The system switches automatically to the MAN/SPONT form of ventilation.
- The buttons to select the forms of ventilation are inactive.

#### Measures for pressure measurement failure

The patient can continue to be ventilated with the ventilation bag.



*If you are unable to fix the error yourself, make a note of the error number and notify a Löwenstein Medical-authorized technician.*

---



#### **WARNING**

Pressure measurement failure!

#### **Too-high ventilation pressures lead to lung damage**

- The patient can continue to be ventilated with the ventilation bag.
  - Set an alternative ventilation pressure measurement.
-

## 13. Maintenance and servicing



**WARNING**

### General information

Device malfunctions during maintenance and servicing work!

#### **Death or permanent injury of the patient**

- Do not carry out any servicing or maintenance work while the device is being used on a patient.

The *leon plus* must be serviced (→ "Servicing interval" p. 275) regularly by a Löwenstein Medical-authorized service technician. All maintenance measures must be entered in a logbook which is prepared in accordance with the relevant statutory legislation. We recommend that servicing should be carried out as part of a servicing and maintenance contract with Löwenstein Medical. The guarantee is terminated if interventions, changes or repairs to the device are made by persons who are not authorised to do so or if the device is used with auxiliary accessories or spare parts of third-party origin.

### Servicing by hospital staff

#### **Change CO<sub>2</sub> absorber**

(→ "Removing and installing the CO<sub>2</sub> absorber" p. 79)

#### **Change bronchial aspiration filter**

(→ "Connection of the bronchial aspiration" p. 91)

## Gas measurement maintenance (sidestream measurement)

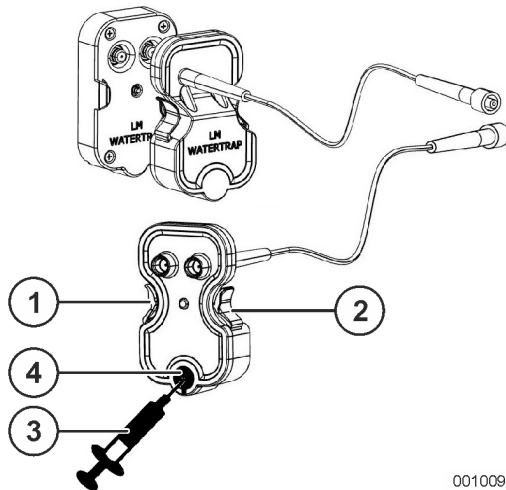

001009

### Changing or emptying the watertrap(LM-Watertrap)

1. Press the flaps on the right and left of the watertrap inwards and take it out.
2. Take a syringe with the needle attached and the piston fully retracted and insert it into the small round black inlay at the bottom of the back of the watertrap.
3. Empty the watertrap by slowly drawing up the syringe. Alternatively, dispose of the watertrap. If the watertrap has been in use for longer than a month, dispose of it.
4. Replace the watertrap by pressing it into the mounting from the front until it has noticeably engaged on both sides.

- (1) strap
- (2) strap
- (3) Syringe with needle
- (4) Inlay

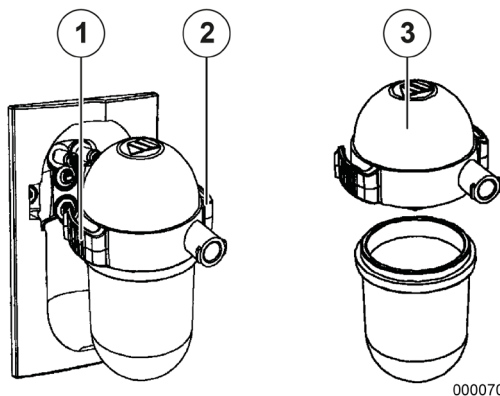

000070

### Changing or emptying the watertrap(DRYLINE™-Watertrap)

1. Press the flaps on the right and left of the watertrap inwards and take it out.
2. Open the watertrap by removing the lid.
3. Empty the watertrap and replace the lid or dispose of it if it has been used for longer than a month.
4. Replace the watertrap by pressing it into the mounting from the front until it has noticeably engaged on both sides.

- (1) strap
- (2) strap
- (3) lid



*When ventilating neonates, please use the watertrap and the sample line for neonates (blue coding (→ "Connecting the sample line (only for variant DRYLINE™ watertrap)" p. 85)).*

**The maximum permissible intervals between necessary interventions of the user in the drainage system**

- with a minimum specified test gas flow (120 or 70 ml/min)
  - adults: 28 h
  - neonates: 34 h
- with a maximum specified test gas flow (only for DRYLINE™ watertrap) (200 or 120 ml/min)
  - adults: 17 h
  - neonates: 20 h

## Flow sensor servicing

At every system test the flow sensors are checked and calibrated. If the check or calibration could not be executed successfully, check:

- soiling
- faulty connection of the plug
- damage (measuring wire ripped, housing breaks, plug broken off, O-ring)

Before cleaning and disinfection the flow sensors must be dismantled and changed if they are damaged.

### Change (dismantling) flow sensors

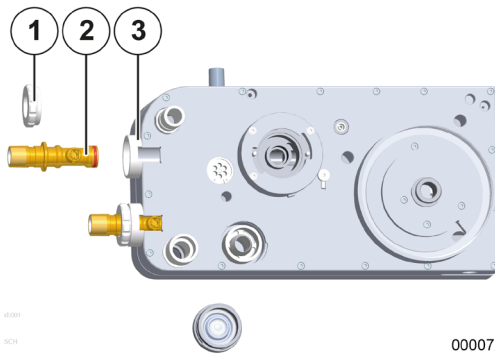

1. Remove the CO<sub>2</sub> absorber.
2. Take the patient module from the docking station on the device.
3. Place the patient module onto a firm base.
4. Remove the lock nuts (turn anticlockwise) that hold the flow sensors in the patient module.
5. Pull the flow sensors out of the carrier.

- 000072
- (1) lock nut
  - (2) flow sensor
  - (3) flow sensor carrier

Installation is carried out in reverse sequence.

(→ "Connection for respiratory bellows, dome and CO<sub>2</sub> absorber, PEEP valve diaphragm cover, flow sensors" p. 66)



*Slide the flow sensor with the side on which the O-ring is positioned into the patient module. Take care when installing that the plug on the flow sensor is guided into the nut of the patient module carrier.*

## PEEP valve diaphragm servicing

Before cleaning and disinfection the PEEP valve diaphragm must be dismantled and changed if damaged.

### Change (dismantling) PEEP valve diaphragm

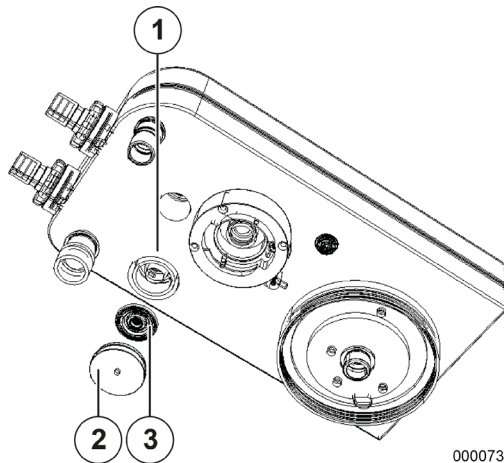

#### Remove the PEEP valve diaphragm

1. Remove the CO<sub>2</sub> absorber.
2. Take the patient module from the docking station on the device.
3. Place the patient module onto a firm base.
4. Remove the PEEP valve membrane cover (turn bayonet catch anticlockwise) that holds the PEEP valve diaphragm in the patient module.
5. Remove the PEEP valve membrane.

(1) PEEP valve diaphragm carrier

(2) PEEP valve diaphragm cover

(3) PEEP valve diaphragm

Installation is carried out in reverse sequence.

(→ "Connection for respiratory bellows, dome and CO<sub>2</sub> absorber, PEEP valve diaphragm cover, flow sensors" p. 66)

#### Installation of the PEEP valve diaphragm

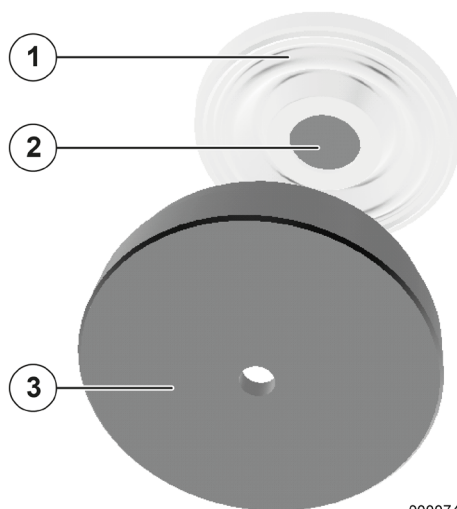

(1) PEEP valve diaphragm

(2) metal disc

(3) PEEP valve diaphragm cover



**!**  
**ATTENTION**

Faulty installation of the PEEP valve diaphragm!

**Device malfunction**

- Place the diaphragm in the diaphragm cover so that the metal disc in the diaphragm can be seen through the hole in the cover.

### Servicing of the insp./exp. valve diaphragms

Before cleaning and disinfection the insp./exp. valve diaphragm(s) must be dismantled and changed if damaged.

#### Change (dismantling) of the insp./exp. valve diaphragms

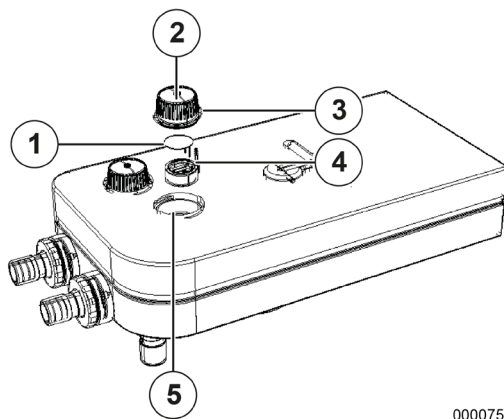

000075

#### Changing the valve diaphragm

- Remove the inspection glass by turning anticlockwise and lift it out.
- Put the valve diaphragm holder on the peg provided for it from its seat in the patient module.
- Tear the old valve diaphragm from the valve diaphragm holder. Remove any remnants from the valve diaphragm holder.
- Pull the two flag rods of the new valve diaphragm through the drill-holes provided in the valve diaphragm holder until the valve diaphragm lies evenly all over the valve diaphragm holder.
- Cut the two flag rods sticking out from the valve diaphragm holder as short as possible.

- (1) valve diaphragm
- (2) inspection glass
- (3) O-ring
- (4) peg
- (5) seat in the patient module

**!**  
**ATTENTION**

Faulty installation of the valve diaphragm!

**Device malfunction**

- Cut off the two flag rods sticking out from the inside of the valve diaphragm holder.
- If the valve diaphragms are removed from the diaphragm holder, these valve diaphragms may not be used again and must be replaced by new valve diaphragms.

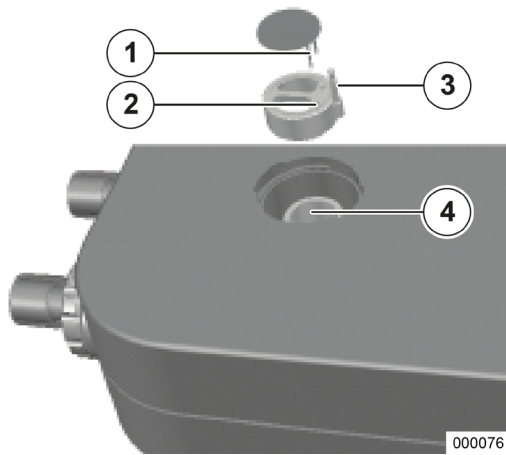
**Installation of the valve diaphragm**

- (1) valve diaphragm flag rods
- (2) valve diaphragm holder drill-holes
- (3) valve diaphragm holder peg
- (4) valve diaphragm holder seat

**Servicing of fans**

---

Change the fan filter pad on the rear of the housing if soiling is detected.

1. Pull the protective grid vertically from the mounting.
2. Change the filter pad.
3. Press the protective grid back into the mounting.

## Servicing of reserve gas bottles and 10 L bottles

---

### Regular checks of the reserve gas cylinders and 10 L cylinders

 (→ "10 L bottle connection instead of CGS" p. 74)

#### Safety

---



#### WARNING

Cylinder valves, high pressure regulator and connected fittings!

##### Explosion risk

- Do not use any kind of tool to open the cylinder valves.
  - Oil and fats can react violently with some gases under pressure (O<sub>2</sub>, N<sub>2</sub>O (laughing gas), compressed air and their mixtures).
    - Do not grease or oil the connections for reserve gas cylinders.
    - Avoid contact between hand cream and the fittings.
- 



#### WARNING

O<sub>2</sub> strongly encourages burning when in contact or mixed with flammable materials.

##### Risk of burning

- Before connection it is essential that the compatibility of the gas type of the high-pressure regulator and the supply is ensured.
  - Ensure good ventilation.
  - No smoking and no bare flames.
- 



#### WARNING

N<sub>2</sub>O has a strong anaesthetic effect and increases the flammability of all flammable substances.

##### Danger of O<sub>2</sub> shortage and respiratory standstill

- Before connection it is essential that the compatibility of the gas type of the high-pressure regulator and the supply is ensured.
  - Ensure good ventilation.
  - No smoking and no bare flames.
- 



#### ATTENTION

It must be insured through special guards that no dangerous pressure can build up in devices that are connected to the high-pressure regulator. The poppet valve of the high-pressure regulator is not suitable as protection for this device.

The high-pressure regulator is not fitted with a back pressure manometer. If monitoring of the back pressure in operation is desired, it is monitored by the connected device.

---

## Replacing the reserve gas bottles and 10 L bottles

### Preparation of reserve gas bottles

For the high-pressure regulator to function perfectly it is required that the bottle valve is in a clean condition and that dust-free and dry gases are used.

1. Check the label to see whether the available high-pressure regulator is suitable for the intended application purpose (gas type, pressure). The maximum permissible inlet pressure of the high-pressure regulator should be equal to or higher than the full pressure of the bottle.

(→ "Technical data" p. 320)

2. In well-ventilated rooms or in the fresh air: Before connecting the high-pressure regulator, open the valve of the pressure gas bottle slowly but briefly to blow off contaminants.
3. Take off the protective caps from the connections of the high-pressure regulator and keep them to one side.
4. Screw the pressure bottle to the high-pressure regulator.
  - The connections must fit to each other directly.
  - Do not use any adapter pieces!

 *All connections must be clean, as well as free from oil and grease! Do not use any lubricants! These could soil the high-pressure regulator. Also, when using O<sub>2</sub> or N<sub>2</sub>O there is a risk of burning.*

5. Plug the high-pressure sensors into the sockets in the rear wall of the device (only with 10 L bottles).

(→ "Technical data" p. 320)



### WARNING

---

Pressure surges through quick opening!

#### Explosion risk

- Do not direct gas jet at people.
- 

### Manual connection of the high-pressure regulator

To facilitate joining the high-pressure regulator to the bottle valve, the high-pressure regulator is fitted with a manual connector.

When connecting, be sure not to use a tool to screw it on.

The connection must be removed without pressure. The removal of the connection under pressure and using a tool may only be carried out in an emergency. The seal ring is destroyed by this procedure.

**Cleaning and disinfection of the high-pressure regulator**

<b>Before cleaning and disinfection</b>	Close the inlet connection with suitable caps if the high-pressure regulator is not connected to a gas cylinder.
<b>Cleaning of the high-pressure regulator</b>	Clean the surface of the high-pressure regulator with a disposable cloth.
<b>Disinfection of the high-pressure regulator</b>	For disinfection, use permitted, commercial preparations from the group of surface disinfectants. Observe the manufacturer's instructions for use.  The high-pressure regulator may not be immersed in fluids and may not be sterilised!
<b>Maintenance of the high-pressure regulator</b>	(→ "Maintenance of the high-pressure regulator" p. 279)

**Troubleshooting the high-pressure regulator and reserve gas cylinders**

Table 58: Faults and fault-fixing

	<b>Problem</b>	<b>Possible cause</b>	<b>Remedy</b>
Case 1	Link between bottle and high-pressure regulator is untight	Seal ring damaged	Replace seal ring
Case 2	Back pressure increases, poppet valve discharges	Valve seat soiled or damaged	Repair by a Löwenstein Medical-authorized service technician
Case 3	Untightness in the area of the spring bonnet	Valve damaged	Repair by a Löwenstein Medical-authorized service technician
Case 4	Maximum flow is not reached	Filter in the inlet pressure connection blocked	Repair by a Löwenstein Medical-authorized service technician

## Disposal



*For the professional removal of separated fluids (e.g. fluids from reusable water traps) please refer to the hygiene guidelines of your hospital.*

## Disposal of gas

---

- Proper discharge of calibration gases** Carry out the calibration in well-ventilated rooms only. Refer to the hygiene guidelines of your hospital.
- Proper discharge of sampled gases** Connect the device to a narcotic gas aspiration hose to remove the sampled gas.

## Disposal of soda lime

---

The soda lime can be contaminated by patient gas. For disposal please refer to the hygiene guidelines of your hospital.

## Disposal of bronchial aspiration filter

---

The filter can be contaminated by patient gas, blood, stomach and tracheal secretions. For disposal please refer to the hygiene guidelines of your hospital.

## Disposal of water trap and sample line

---

Water trap and sample line can be contaminated by patient gas. For disposal please refer to the hygiene guidelines of your hospital.

### **Disposal of O<sub>2</sub> sensor**

---

The O<sub>2</sub> sensor contains lead. It may therefore not be disposed of with household waste. For disposal please refer to the hygiene guidelines of your hospital.

### **Disposal of flow sensor**

---

The flow sensors can be contaminated by patient gas. A repair of the flow sensor is not possible. For disposal please refer to the hygiene guidelines of your hospital.

### **Disposal of valve diaphragm**

---

The valve diaphragms can be contaminated by patient gas. For disposal please refer to the hygiene guidelines of your hospital.

### **Disposal of fan filter pad**

---

May not be disposed of with household waste.

### **Disposal of electric and electronic components of the device**

---

In general, electric and electronic components of the device are only disposed of during servicing.

Otherwise, dispose of this material according to the label if marked. If in doubt, please proceed in accordance with the disposal guidelines of your hospital or contact a Löwenstein Medical representative.

## **Disposal of battery**

---

Dispose of this material according to the label if marked. If in doubt, please proceed in accordance with the disposal guidelines of your hospital or contact a Löwenstein Medical representative.

## **Changing and filling reserve gas bottles or 10 L bottles**

---

Please refer to the guidelines of your hospital.

## **Maintenance by authorised service technicians**

### **General information**

---

A maintenance service contract should be taken out. Please contact a Löwenstein Medical-authorised service technician or another Löwenstein Medical representative.

Use only original components by Löwenstein Medical for maintenance.

Before beginning maintenance an inspection is required (establishment of actual state). The inspection establishes whether along with the actual maintenance other measures are needed to maintain or restore the proper operational state of the device.



## Servicing interval

---

### **Every 12 months (servicing):**

- STC (to establish faults)
- annual service
- system adjustment/system calibration
- STC (check of work carried out)

### **Every 3 years or every 10,000 operating hours (general overhaul) :**

- STC (to establish faults)
- annual service
- 3-year service
- system adjustment/system calibration
- STC (check of work carried out)

### **Every 6 years or every 20,000 operating hours (general overhaul) :**

- STC (to establish faults)
- annual service
- 3-year service
- 6-year service
- system adjustment/system calibration
- STC (check of work carried out)

## Replacing and calibrating the O<sub>2</sub> cell

### O<sub>2</sub> Sensor

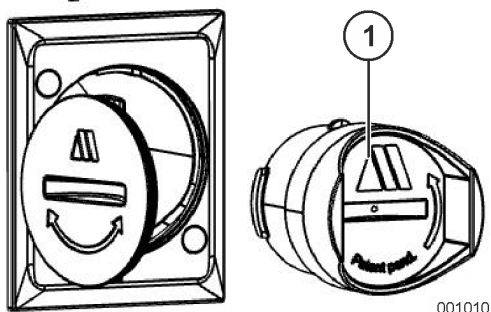

### O<sub>2</sub> cell on the rear panel (*in preparation*)

1. Switch off the *leon plus* .
2. Remove the lid located in the centre on the rear panel of the device in front of the O<sub>2</sub> cell (use a coin and turn the lid to the left to remove it).
3. Remove the O<sub>2</sub> cell (use a coin and turn the O<sub>2</sub> cell anticlockwise).
4. Insert the new O<sub>2</sub> cell.
5. Close the lid.
6. Remove the sample line from the patient adapter.
7. Switch on the *leon plus* .
8. Let a ventilation run for at least 20 seconds. Then stop the ventilation.
9. Start the calibration routine.
10. Wait for the confirmation that calibration was successful.

(1) O<sub>2</sub> cell

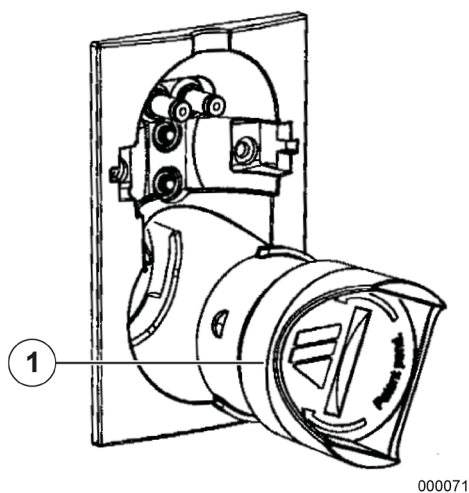

### O<sub>2</sub> cell in DRYLINE™ watertrap

1. Switch on the *leon plus* .
2. Let a ventilation run for at least 20 seconds. Then stop the ventilation.
3. Remove the watertrap.
4. Remove the O<sub>2</sub> cell (use a coin and turn the O<sub>2</sub> cell anticlockwise).
5. Insert the new O<sub>2</sub> cell.
6. Remove the sample line from the patient adapter.
7. Insert the watertrap **with the sample line connected to the watertrap.**
8. Wait approx.20 seconds.

(1) O<sub>2</sub> cell

## Side power measurement servicing

### Calibration (side power measurement)

A calibration is recommended.

- annually (during service)
- in the event of suspicion of extreme deviation from a measured value

### Test arrangement for calibration (LM Watertrap)

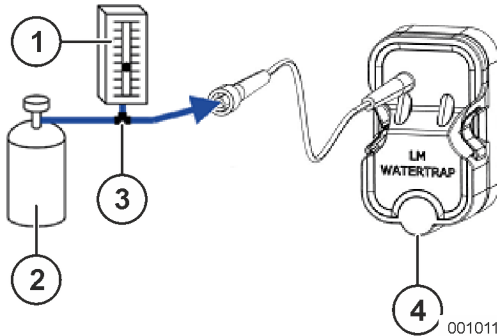

### Test arrangement for calibration (DRYLINE™ watertrap)

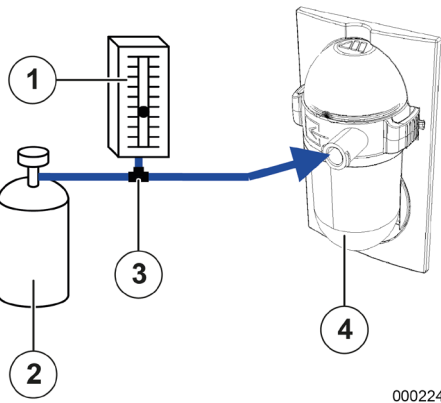

Required:

- (1) Flow meter: (measuring range 0–200 ml/min)
- (2) Calibration gas
- (3) Y-piece: (for inner tube diameter 2 mm)
- (4) Watertrap

💡 *The flow meter is needed to ensure that the multi gas analyser does not draw in any air from the room at the same time.*

Table 59: Calibration gas concentration

Gas	Concentration [%]	Tolerance [%]
CO <sub>2</sub>	6	±0.06
N <sub>2</sub> O	45	±0.45
O <sub>2</sub>	45	±0.45
desflurane	4	±0.04

The components of the used calibration gas must have the accompanying concentrations:

#### Execution of the calibration (sidestream measurement)

1. Put the test arrangement together  
(→ "Test arrangement for calibration" p. 277).
2. Turn on the device.
3. Start the MAN/SPONT form of ventilation.
4. Open the valve of the calibration gas cylinder until a value between 0–10 ml/min can be read on the flow meter (to ensure that the multi gas analyser is drawing in calibration gas only).
5. Wait 30 seconds for the system to stabilise.
6. Compare the measured values including tolerance with the values given on the calibration gas cylinder.



#### ATTENTION

#### Storing of the calibration gas

The storage temperature is between 18 °C and 25 °C.

If a storage temperature of 5 °C is exceeded a 1-hour mixture (at 18 °C to 25 °C) is required before the given concentrations are reliable.

- Twist or turn the container



*If the values are outside of the tolerance, notify a service technician authorised by Löwenstein Medical.*

## Maintenance of the high-pressure regulator

---

Maintenance may be carried out only by trained specialist staff and with original Löwenstein Medical spare parts!

Under normal demands an inspection is carried out every 12 months, during which the device is inspected for external damage and its functionality is checked.

In addition, a general overhaul must be carried out every 6 years, which includes the replacement of all worn components.

In the event of unusually high demand shorter servicing intervals may be required.

## Technical safety controls

---

### General information

Scope and periods of technical safety controls in accordance with the German Medical Devices Act (MPG)/Medical Devices Operator Ordinance (MPBetreib V) Section 6.



*The controls listed here must be carried out in this scope as a minimum.*

### Periods

The following controls must be carried out on this device at least every 12 months. They may be carried out only by persons who, due to their education, knowledge and experience gained from practical activity, provide the guarantee for a proper execution of the technical safety controls that, with regard to this controlled activity, are subject to no court orders and have suitable measuring and test facilities.

### Scope of the tests and documentation

All test and measuring results must be logged in the medical product book.

**Mechanical safety**

Table 60: Tests – mechanical safety

Gas connection tubes	Check the gas connection tubes for O <sub>2</sub> , AIR and N <sub>2</sub> O with regard to mechanical damage and untightness.
Keypad	Check for mechanical damage, legibility and function
Touchscreen	Check for mechanical damage and function
Patient module	Check for mechanical damage
Bag-in-bottle unit	Check for mechanical damage
CO <sub>2</sub> absorber	Check for mechanical damage
Anaesthetic vaporiser (if available)	Check brakes and check for mechanical damage
Monitor support arm (if available)	Check for perfect mechanical state
Tube support arm (if available)	Check for perfect mechanical state
Cable support arm (if available)	Check for perfect mechanical state
Workstation illumination (if available)	Check for perfect mechanical state and functionality
Trolley	Check wheels and brakes for perfect mechanical state

### Electrical safety

#### General requirements (STC)

Check, assessment of results and documentation of the process/results must be carried out in accordance with DIN EN 62353; measuring devices must also meet these requirements!

Table 61: STC (measured values)

Electrical cables	Check the condition of all of the cables for intactness, brittleness and strain relief.	
Protective conductor resistance <i>leon plus</i>	The protective conductor resistance between the protective contact of the device plug and all exposed metal components of the <i>leon plus</i> , which in the case of a fault can receive direct mains voltage, may not exceed:	0.2 Ohm
Reserve device earth leakage on the <i>leon plus</i>	The reserve device earth leakage on the <i>leon plus</i> must be checked with an appropriate IEC 60601-1 earth leakage measurement device. It is measured on the protective earth conductor or on the components joined to the protective earth conductor, including any connectable units, and may not exceed:	1.0 mA
Insulation resistance	The insulation resistance must be measured between L + N against the protective conductor and may not exceed:	> 2.0 MOhm

## Functional safety

Table 62: Establish functional safety

<b>Check for tightness</b>		1. Execute a system test. (→ "System test" p. 119)
<b>Alarms</b>		2. Check the alarm functions. (→ "Test of alarm functions" p. 134)
<b>PEEP valve</b>		3. Connect an external pressure measurement to the y-piece followed by a commercial artificial lung. 4. Start controlled ventilation. 5. Set the various PEEP values and compare the displayed values with the external pressure meter.
<b>Ventilation pressure</b>		6. Connect an external pressure measurement to the y-piece followed by a commercial artificial lung. 7. Start controlled ventilation. 8. Set the various pressure values on the leon <i>plus</i> and compare the displayed values with the external pressure meter.
<b>Fresh gas blender</b>	<b>Flow</b>	9. Connect an external flow meter to the connection pin for fresh gas. 10. Set the various flow values on the leon <i>plus</i> and compare the displayed values with the external flow meter.
	<b>Gas concentrations</b>	11. Connect an external gas measurement to the connection pin for fresh gas. 12. Set a flow of 2 l/min for O <sub>2</sub> on the leon <i>plus</i> . 13. Set various O <sub>2</sub> concentrations on the leon <i>plus</i> . 14. Compare the set values with the external gas meter.
<b>Anaesthetic vaporiser</b>		15. Connect an external gas measurement to the connection pin for fresh gas. 16. Set a flow of 2 l/min on the leon <i>plus</i> . 17. Set the various concentrations on the anaesthetic vaporisers and compare the set values with the external gas measurement.



Table 62: Establish functional safety

<b>Gas measurement</b>		<b>18.</b> Check the calibration. (→ "Calibration (side power measurement)" p. 277)
<b>O<sub>2</sub></b>	<b>Ratio system</b>	<b>19.</b> Start controlled ventilation. <b>20.</b> Select AIR as carrier gas and set an O <sub>2</sub> concentration of 21%. <b>21.</b> Select N <sub>2</sub> O as carrier gas. The setting of the O <sub>2</sub> concentration jumps to 25%.
	<b>N<sub>2</sub>O cut-off</b>	<b>22.</b> Start controlled ventilation. <b>23.</b> Pull out the O <sub>2</sub> supply plug from the CGS and wait until the O <sub>2</sub> pressure has dropped to <0.6 kPa × 100 (bar). It is no longer possible to administer N <sub>2</sub> O.
	<b>Flush</b>	<b>24.</b> Proceed according to the leon <i>plus</i> short checklist before start-up. (→ "leon plus Short checklist before start-up" p. 319)
<b>Reserve</b>	<b>Switch-over</b>	<b>25.</b> Start controlled ventilation. <b>26.</b> Unplug the O <sub>2</sub> and N <sub>2</sub> O supply plugs from the CGS and wait until the O <sub>2</sub> and N <sub>2</sub> O pressure has dropped to <2.5kPa × 100 (bar). <b>27.</b> Open the reserve gas bottles.
	<b>Return flow</b>	<b>28.</b> When connected to the CGS, connect an external flow meter to the O <sub>2</sub> and the N <sub>2</sub> O reserve gas bottles connection, as desired. No gas may flow from the connections.
<b>APL</b>		<b>29.</b> Start MAN/SPONT. Set the fresh gas to 6 l/min. Set the APL valve to 20 mbar. Pressure chart P <sub>aw</sub> increases to 20 mbar. <i>Only for APL with rapid venting:</i> Pull the APL valve head upwards. Pressure chart P <sub>aw</sub> decreases to 0 mbar. (→ "APL valve" p. 67)
<b>Batteries</b>		<b>30.</b> Proceed according to the leon <i>plus</i> short checklist before start-up. (→ "leon plus Short checklist before start-up" p. 319)

### Miscellaneous

- Visual check of external changes of the device/system. After changing a system, measured values must be documented as first-measured values.
- Visual check of external faults or damage.
- User manual must be present and correspond to the installed software version.
- Warnings must be present.
- Medical product book must be present.

### Assessment and documentation

If the earth leakage measurement values exceed 0.9 times the permissible values, they must be compared with the previous first measured values. If these are not present, a shortening of the checking interval may be required. If the safety of an external device/system is not given, e.g. through not passing tests, this must be identified by informing the user in writing of the emanating threats.

### Checklist leon *plus* Technical safety controls

A suggestion for a copyable text "Checklist of technical safety controls" for the leon *plus* is located in the final pages of this document.

**14. Accessories****General information**

- 💡 *Observe the accompanying documents for the accessories of other manufacturers.*

Only the following listed accessories and replacement parts may be used with the *leon plus*:

- *leon plus*, *leon* and *leon mri* List of accessories and replacement parts

The use of accessories and replacement parts other than those specified can limit the performance and safety of the system. The accessories and replacement parts that are used with the *leon plus* must nevertheless comply with the requirements of DIN EN 60601-1 or DIN EN ISO 80601-2-13 or 93/42/EEC or MDR (EU) 2017/745.

The following parts, which may come into contact with the patient, but which do not fall under the term application parts, must meet the requirements for applied parts.

- Patient tube system (Type B)
- Gas measurement line (Type B)

**ATTENTION**

---

The user is responsible for ensuring that all accessories and replacement parts are compatible with the system and that their deployment does not impair the normal functionality of the system.

---

If in doubt, contact a Löwenstein Medical representative.

- 💡 *Nothing may be affixed to the system (e.g. stickers). This could lead to important information being concealed, which could lead to an impairment of the patient's safety.*

**Replacement part**

*(→ leon plus, leon and leon mri List of accessories and replacement parts)*

**Accessories**

*(→ leon plus, leon and leon mri List of accessories and replacement parts)*

## 15. Product combinations

### General information

Only the following listed auxiliary devices may be used with the *leon plus*. The use of auxiliary devices other than those specified can limit the performance and safety of the system. The accessories and replacement parts that are used with the *leon plus* must nonetheless comply with the requirements of DIN EN ISO 80601-2-13.

 *The user is responsible for ensuring that all auxiliary devices are compatible with the system and that their deployment does not impair the normal functionality of the system.*

If in doubt, contact a Löwenstein Medical representative.

### Auxiliary devices

If devices from other manufacturers are connected to the *leon plus*, the safety of this equipment must fulfil the requirements of the following standards:

- IEC 60601-1
- IEC 60601-1-2
- IEC 80601-2-13

---

Before the auxiliary sockets can be used, the socket cover above them must be removed.

The total power consumption of the device including the 4 auxiliary outlets may not exceed 9 A.

The workstation may not contain more than these four auxiliary outlets.

The total earth leakage current may not exceed 5 mA in the normal state for connected auxiliary devices. Measuring is recommended.

When connecting devices to the auxiliary outlets, the values of the patient leakage currents can increase to values which exceed the permissible value of 10 mA in the event of a faulty earth wire.

The total weight of the monitor mounted on the top shelf of a support arm is restricted.

With gas monitors with sidestream measurement processes, ensure that the gas measurement sample is not conducted into the room.

---

If in doubt, contact a Löwenstein Medical representative.



## Mounting additional monitors

Additional monitors should only be mounted on the top shelf or fixed to a support arm mounted on the side of the device. Monitors that are mounted on the top shelf must be secured to ensure they do not fall off. For stability reasons, the total weight of the display units on the shelving may not exceed 20 kg. You should also observe the maximum installation height of < 1800 mm (clearance height of doors). For stability reasons, the total weight of the monitors mounted on the support arm (max. Length 500 mm) may not exceed 15 kg.

If in doubt, contact a Löwenstein Medical representative.

## Anaesthetic vaporiser

All anaesthetic vaporisers can be used with a Selectatec or Dräger-compatible mounting, complying with the following standards:

- ISO 5358
- ISO 80601-2-13
- ISO 5360
- ISO 5356-1
- 93/42/EEC or MDR (EU) 2017/745

If in doubt, contact a Löwenstein Medical representative.

## Bronchial aspiration

Only vacuum-driven bronchial aspirations may be connected.

If in doubt, contact a Löwenstein Medical representative.

## Support arms

Only use support arms approved by Löwenstein Medical.

- monitor support arm
- cable support arm
- tube support arm
- PC support arm

If in doubt, contact a Löwenstein Medical representative.

## PDMS

On request.

## HIS

On request.

## AGSS

The AGSS used must comply with the requirements of DIN EN ISO 80601-2-13.

If in doubt, contact a Löwenstein Medical representative.







Gas flow plans

**Legend gas flow plans**







Table 64: Legend for gas flow plans 1	
	Non-return valve open
	Non-return valve closed
	Electrically controlled valve open
	Electrically controlled valve closed
	Gas flow with direction
	Tube system under pressure
	Excess gas

Table 65: Legend for gas flow plans 2

PM	Patient module	B	Ventilation bag
G1	Emergency dosing	NV	Anaesthetic vaporiser
G2	Fresh gas	CB	CO <sub>2</sub> absorber
G3	O <sub>2</sub> flush	Paw	Ventilation pressure
G4	Drive gas	D	Dome
RV1	Decoupling valve	FG	Fresh gas outlet
RV2	Emergency air valve	SV1	Slide valve auto/manual 1
RV3	Inspiratory valve diaphragm	SV2	Slide valve auto/manual 2
RV4	Expiratory valve diaphragm	SV3	Slide valve of open system
RV5	Absorber decoupling valve	SV4	Fresh gas outlet change-over valve
VC1	Plateau valve	F1	Inspiratory flow sensor
VC2	PEEP valve	F2	Expiratory flow sensor
APL	Manual overdrive valve	AGSS	Connection to the anaesthesia gas scavenging system
PV	Excess diaphragm		

**Manual ventilation (patient module 0209100)**

**Inspiration (manual)**

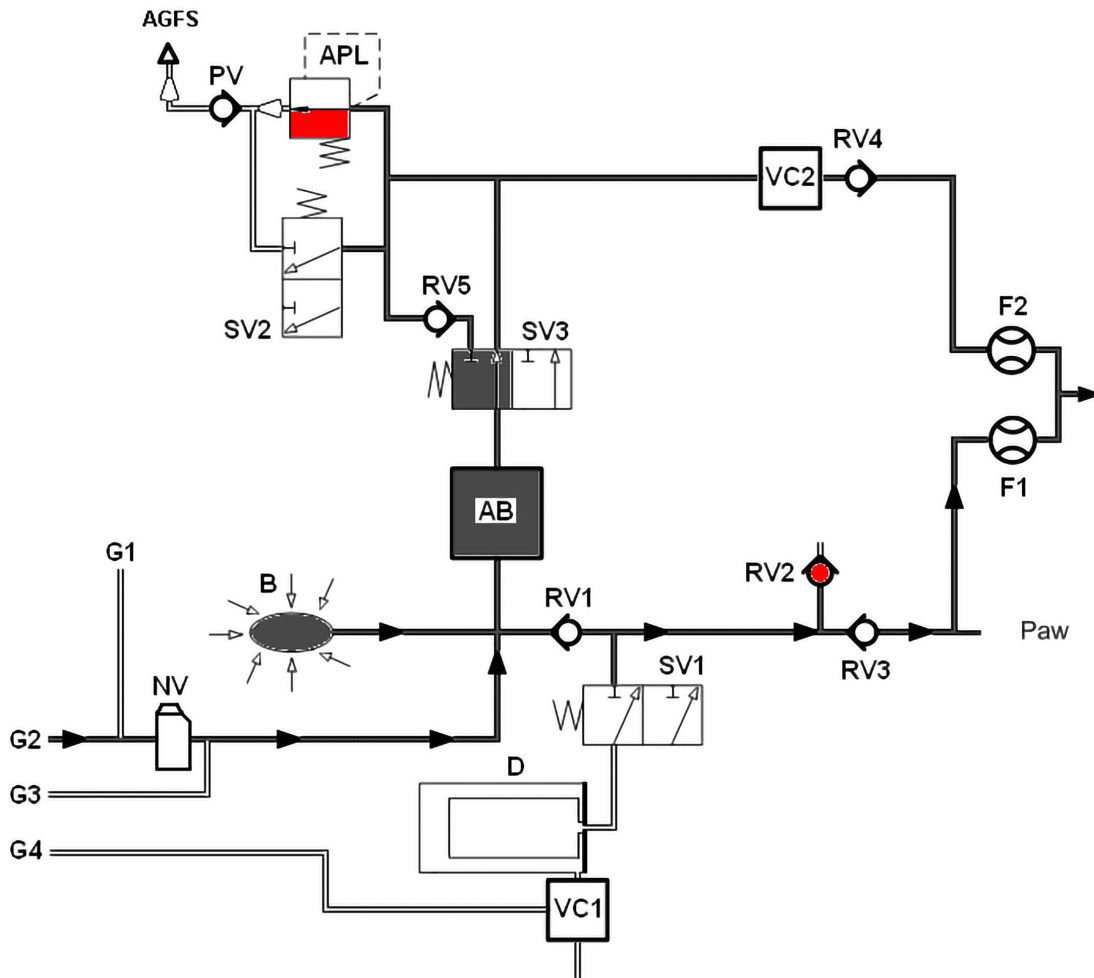

Fig. 1: Manual ventilation, inspiration patient module

Expiration (manual)

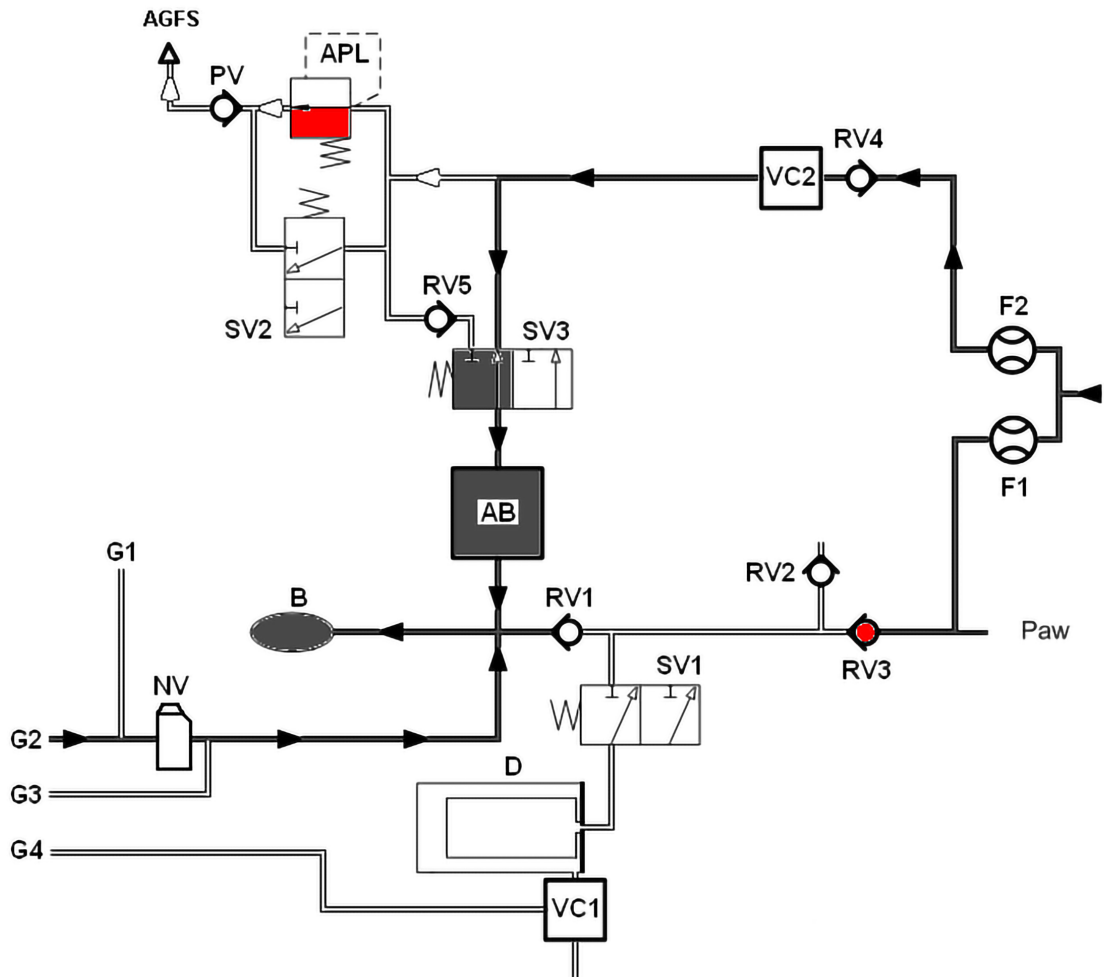

Fig. 2: Manual ventilation, expiration patient module

**Mechanical ventilation (patient module 0209100)**

**Inspiration (semi-closed)**

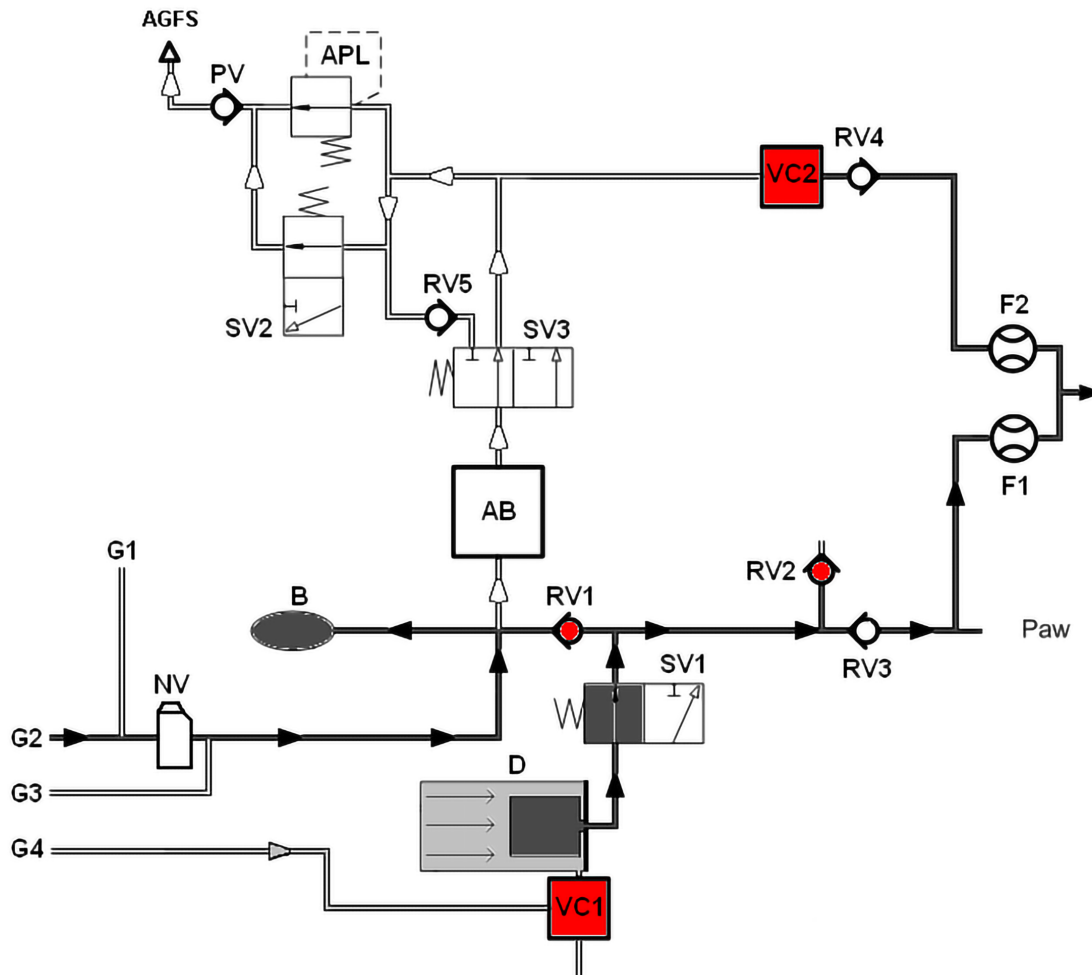

Fig. 3: Inspiration patient module (semi-closed)

Expiration (semi-closed)

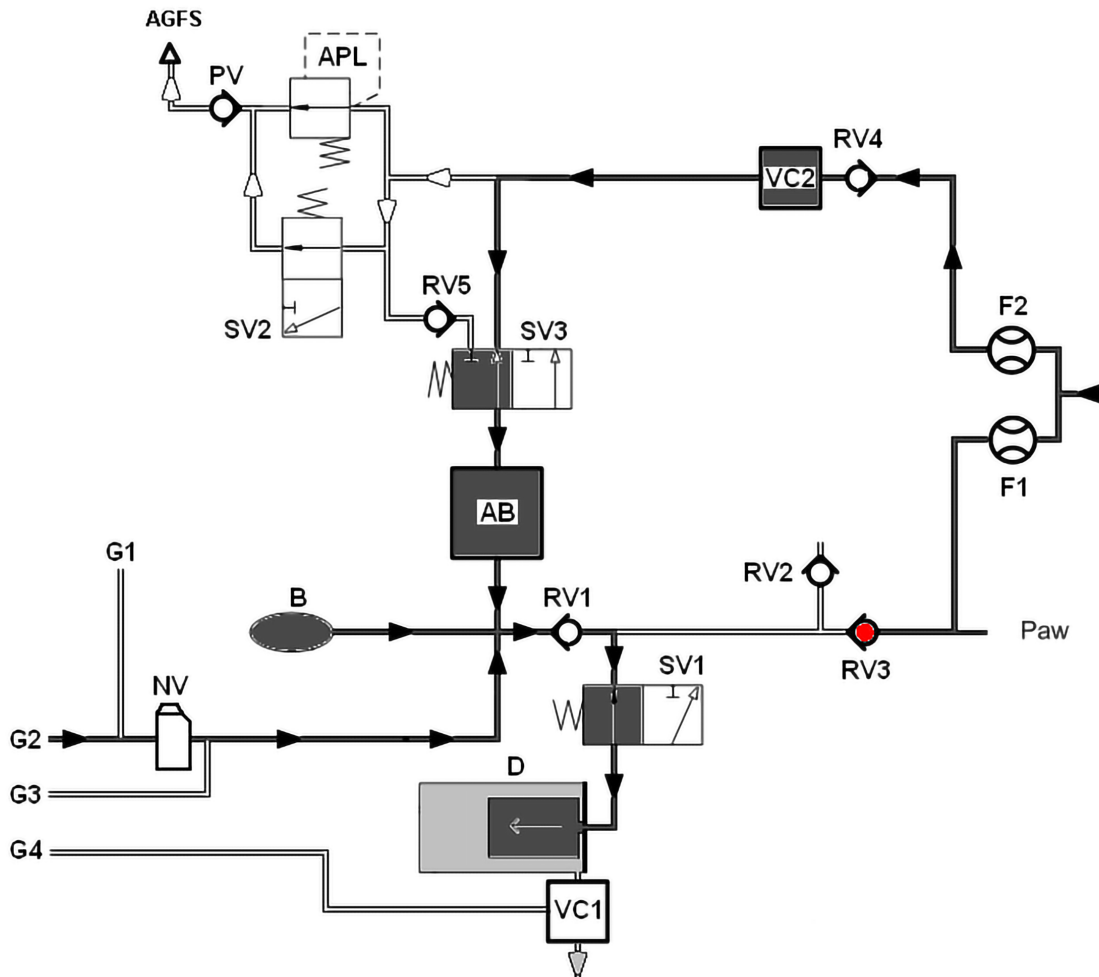

Fig. 4: Expiration patient module (semi-closed)

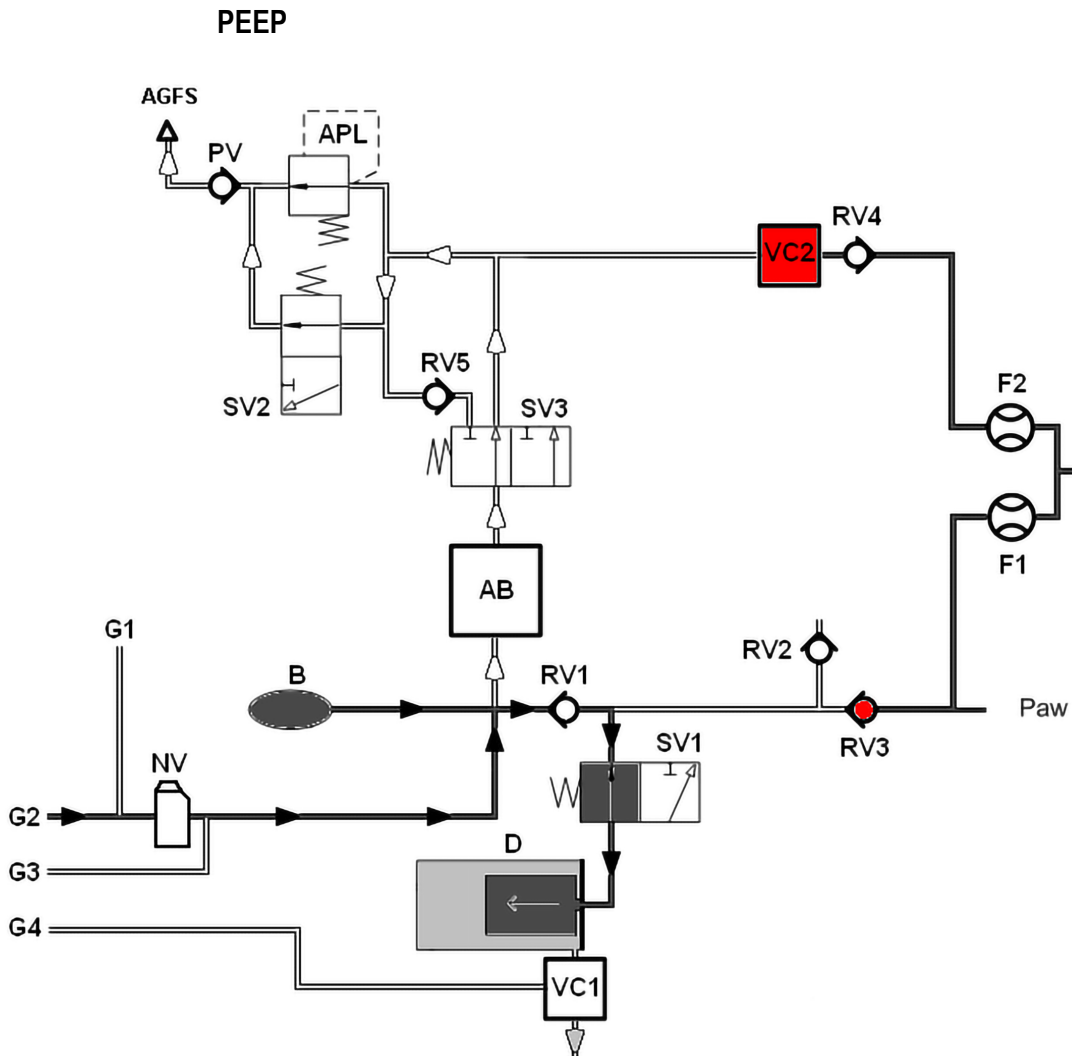

Fig. 5: PEEP patient module



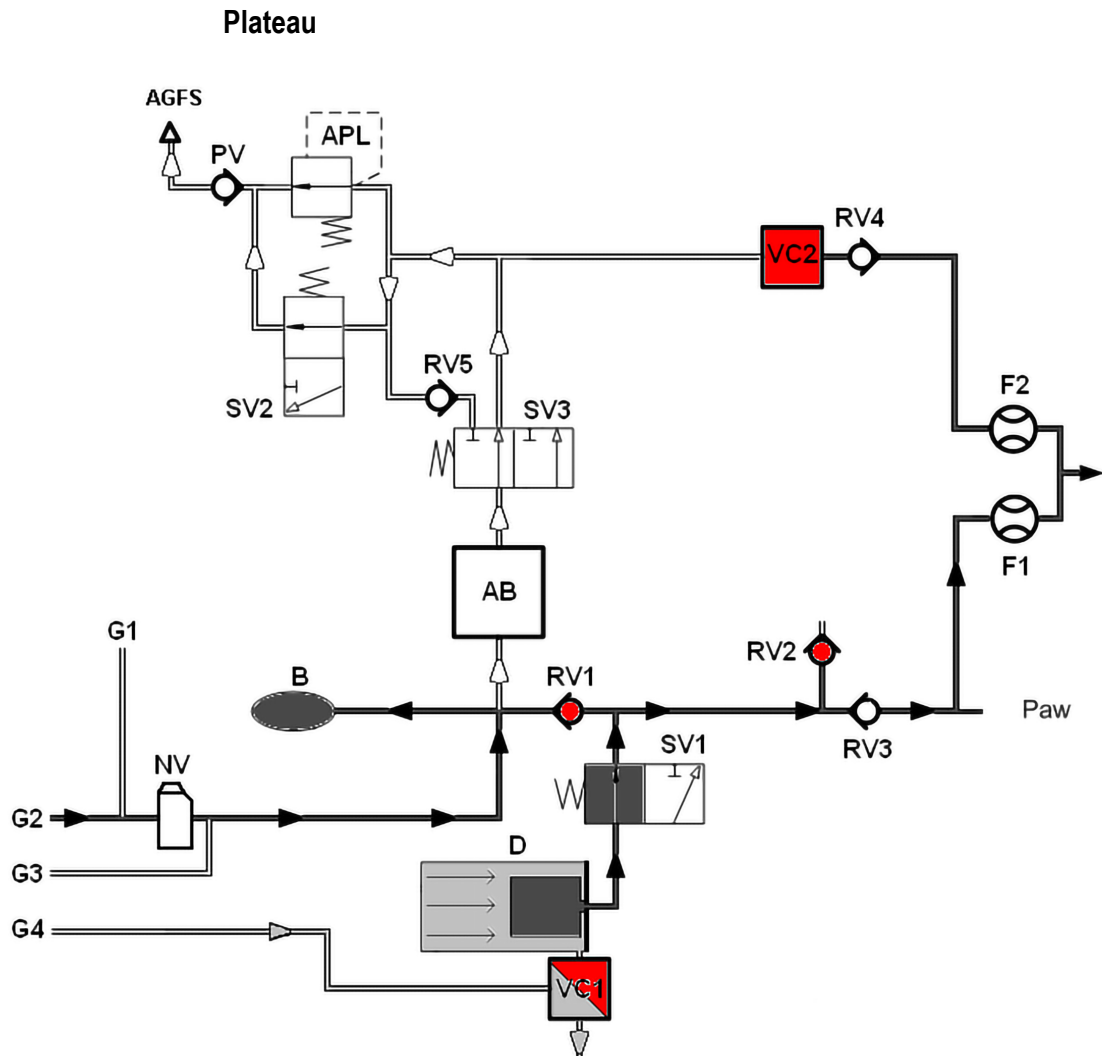

Fig. 6: Plateau patient module

**Manual ventilation (patient module 0209100hul200)**

Inspiration (manual)

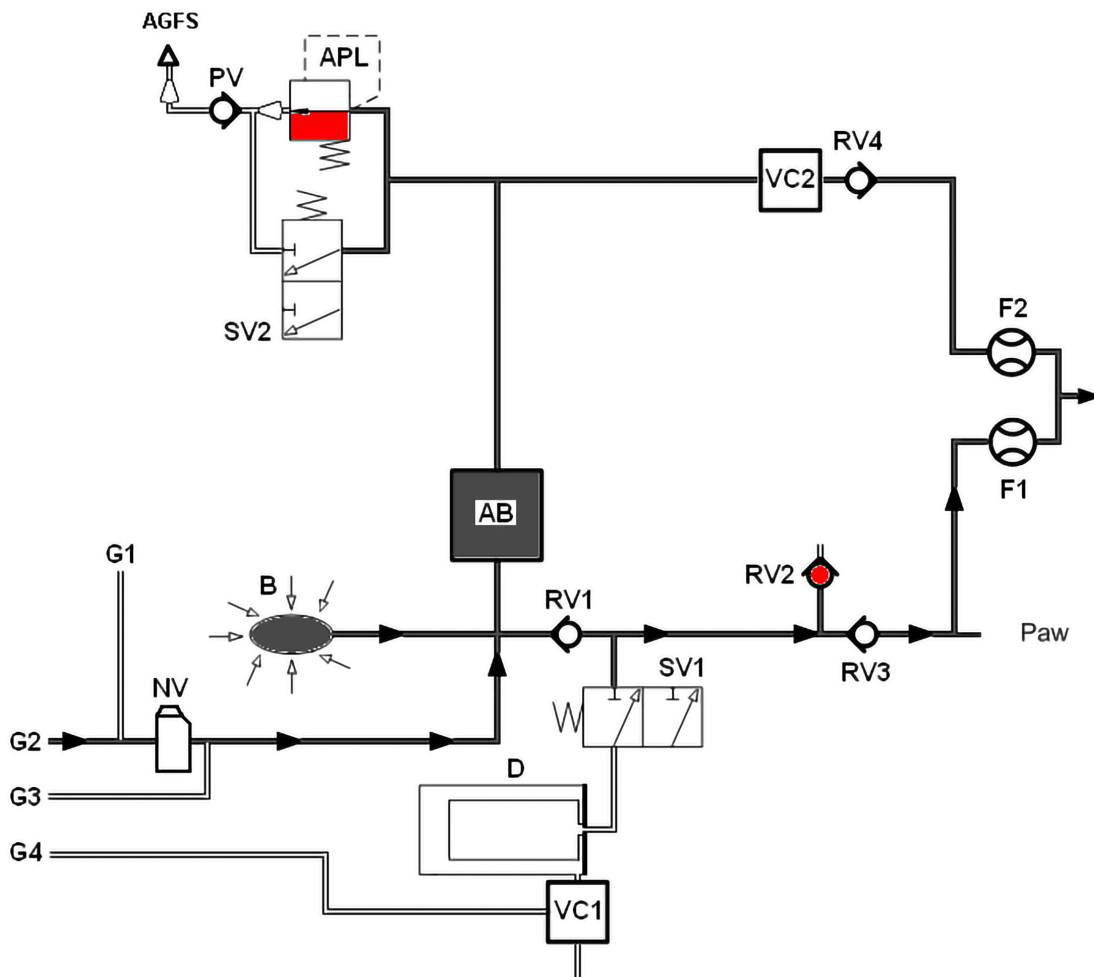

Fig. 7: Manual ventilation, inspiration patient module hul200



**Mechanical ventilation (patient module 0209100hul200)**

Inspiration (semi-closed)

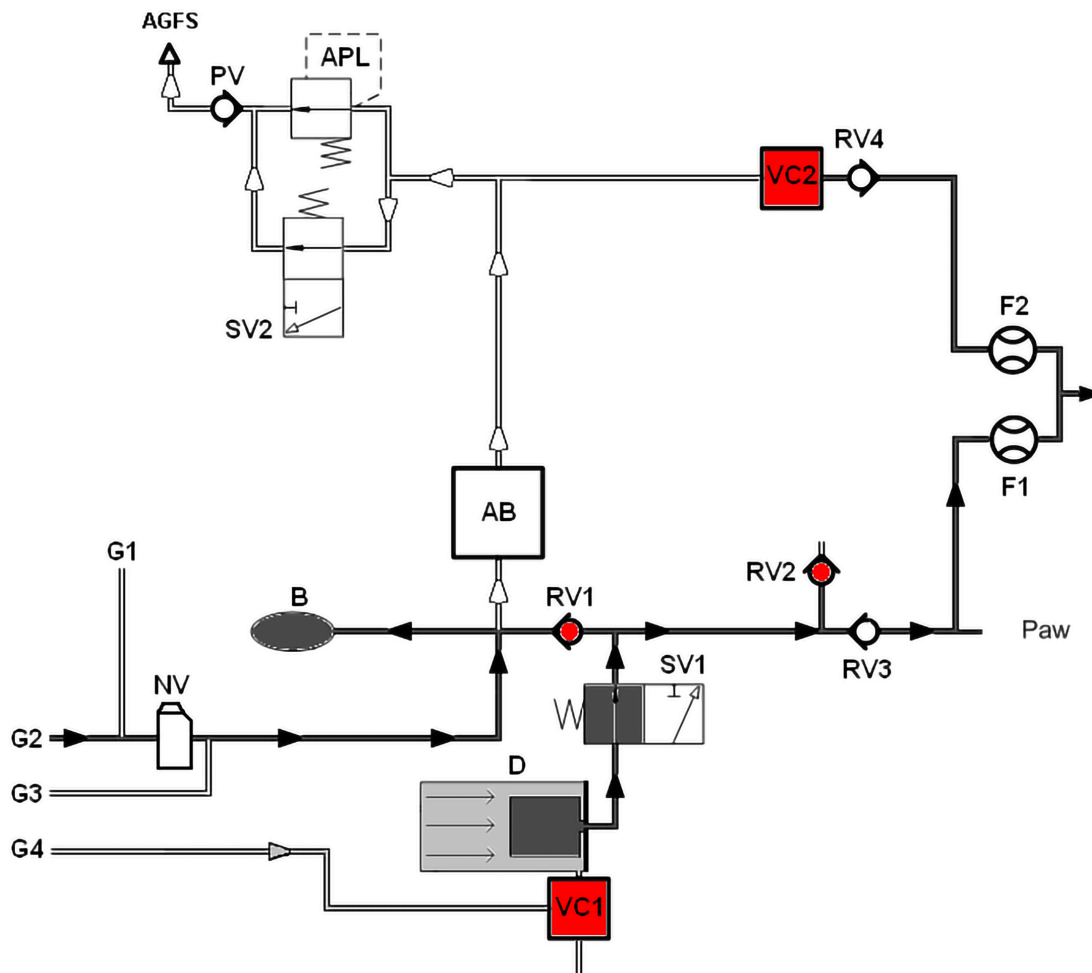

Fig. 9: Inspiration patient module hul200 (semi-closed)

Expiration (semi-closed)

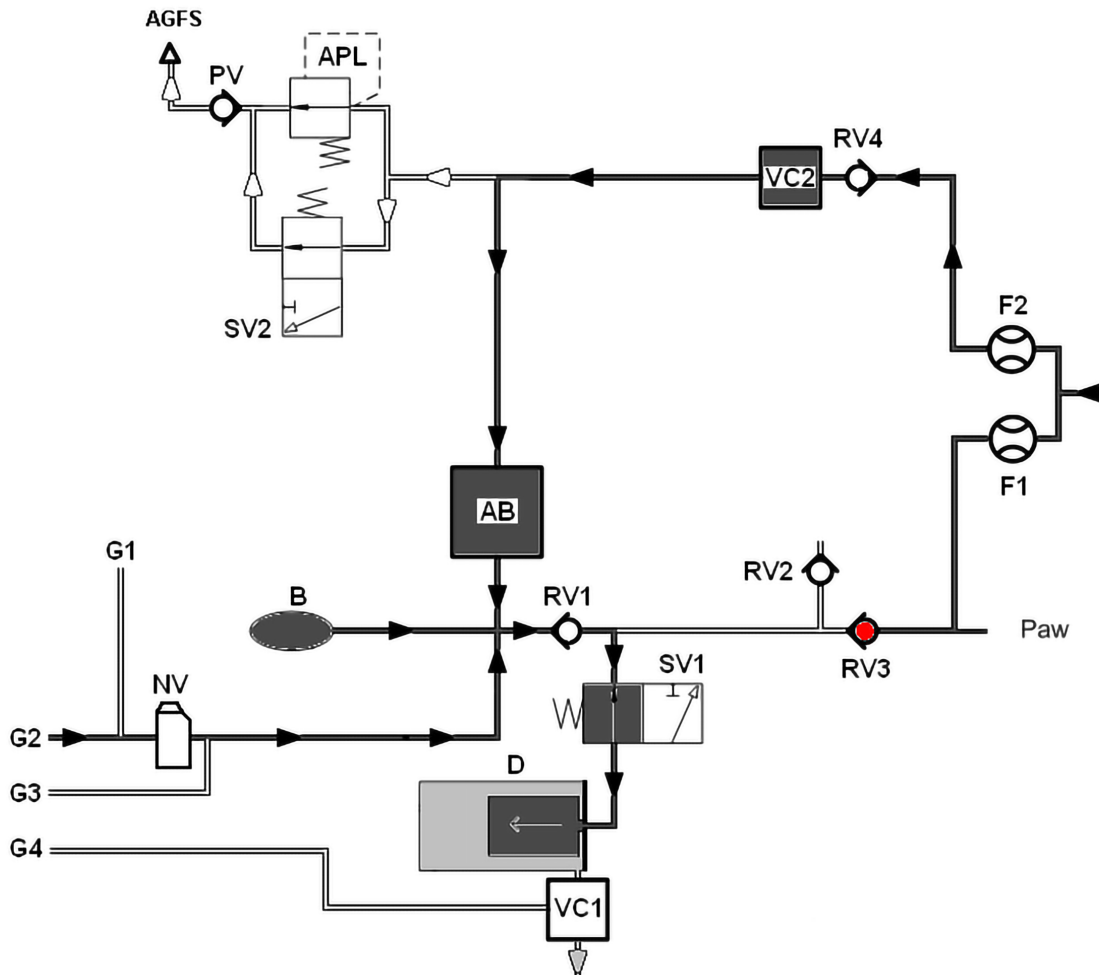

Fig. 10: Expiration patient module hul200 (semi-closed)

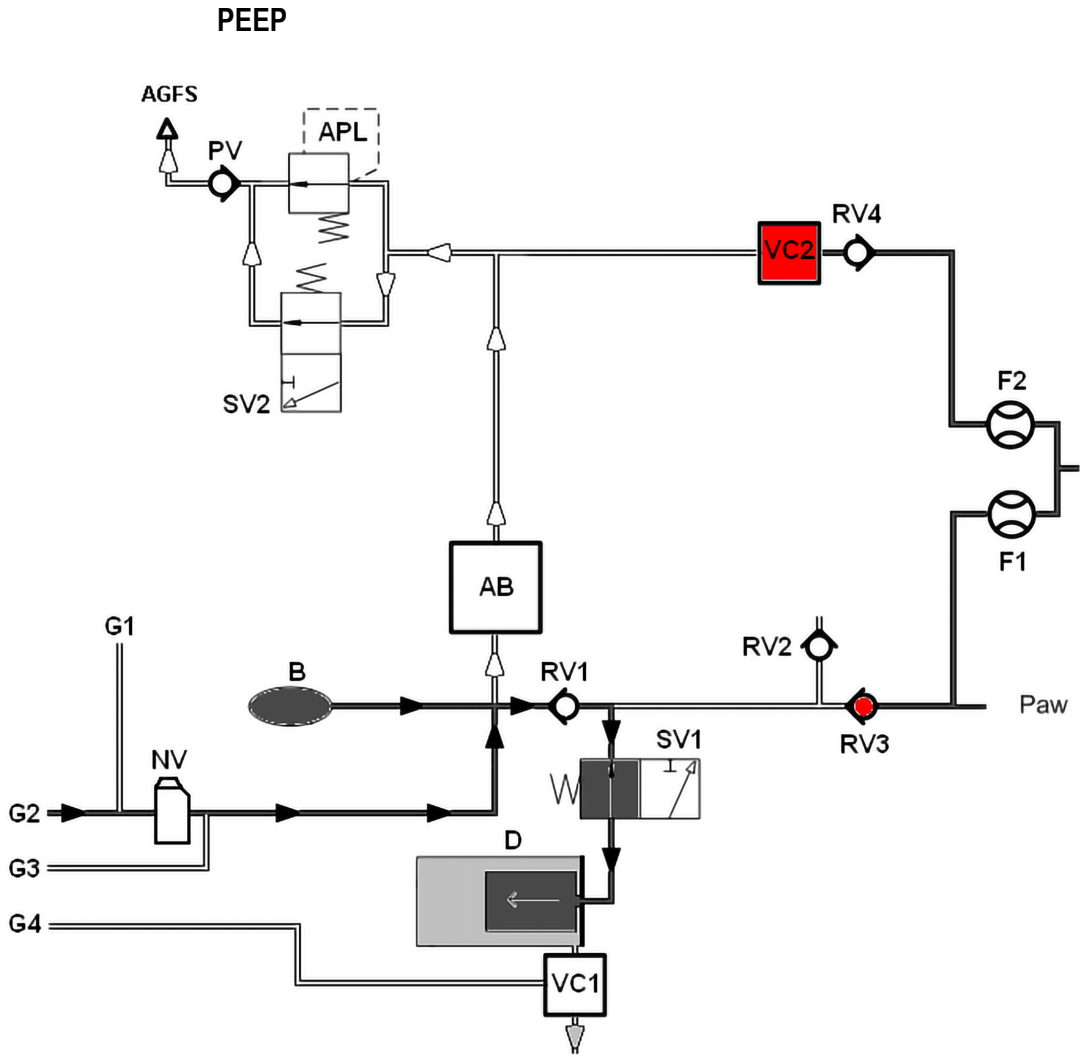

Fig. 11: PEEP patient module hul200

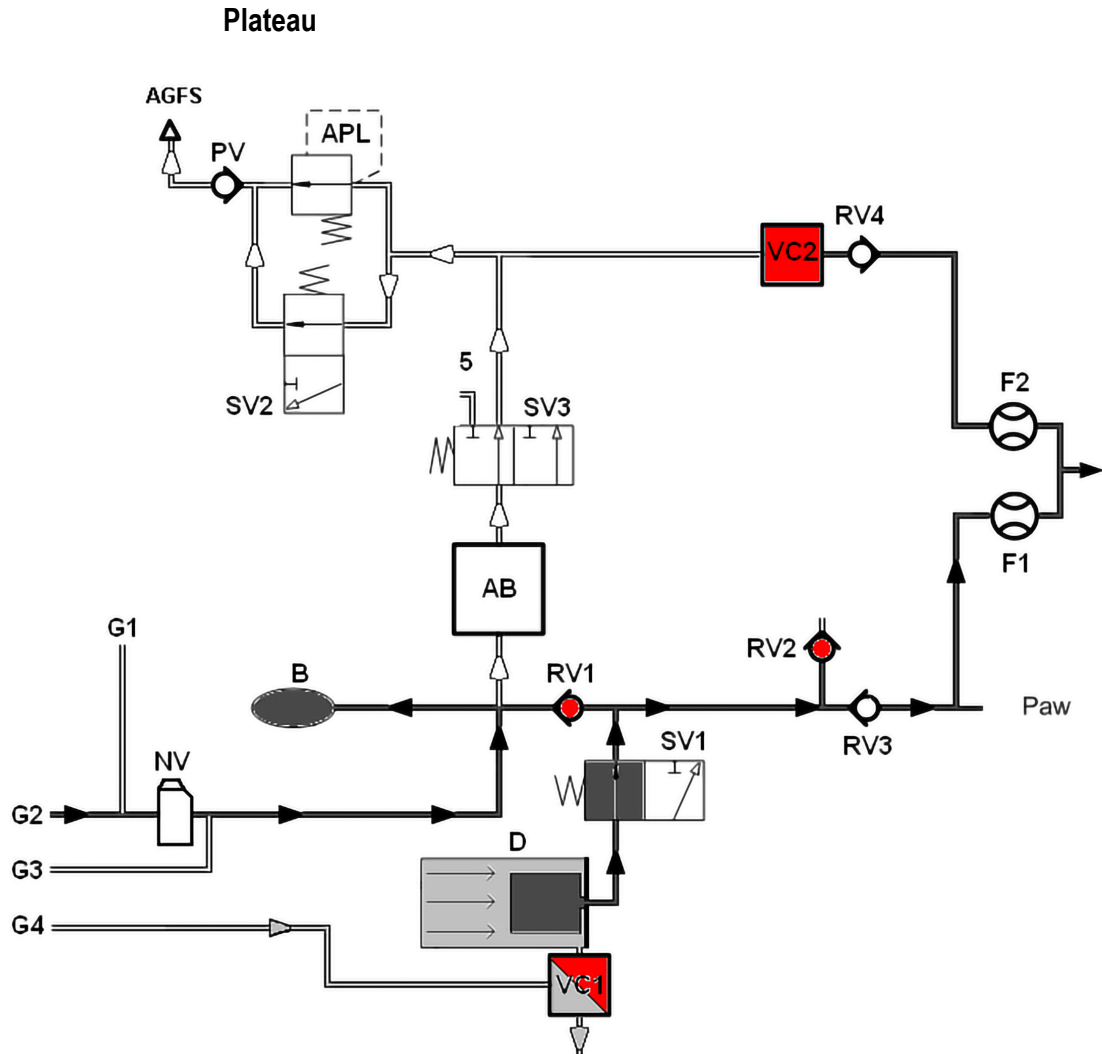

Fig. 12: Plateau patient module hul200

**Manual ventilation (patient module 0209100Im300)**

**Inspiration (manual)**

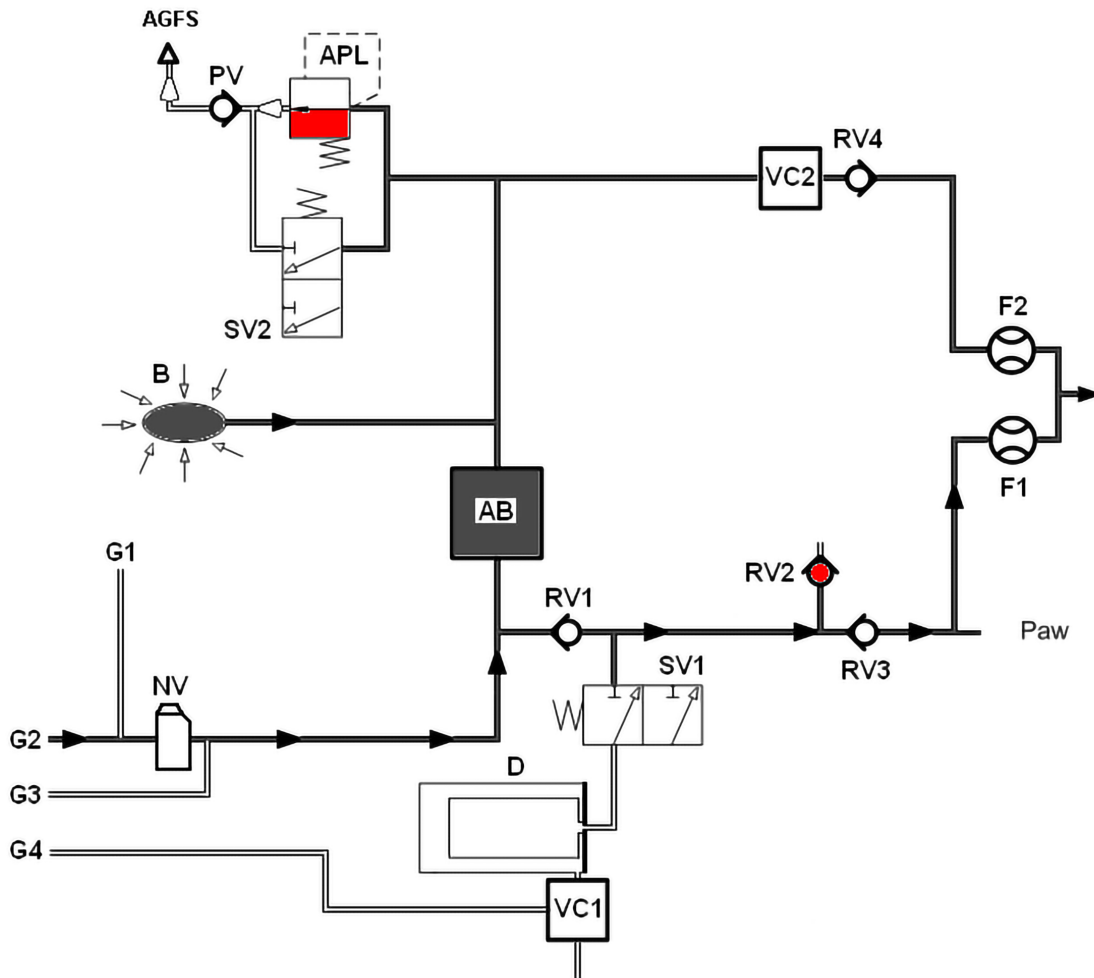

Fig. 13: Manual ventilation, inspiration patient module Im300



Expiration (manual)

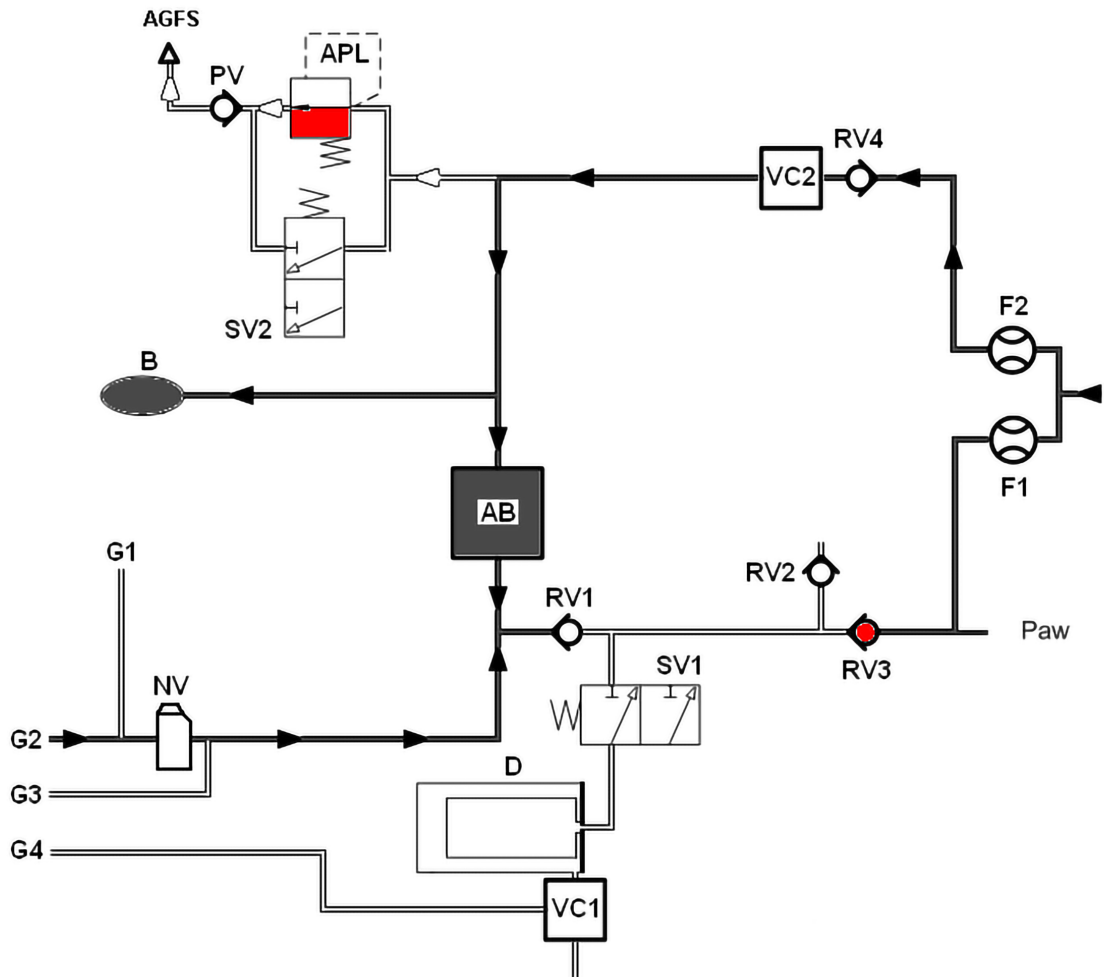

Fig. 14: Manual ventilation, expiration patient module Im300

**Mechanical ventilation (patient module 0209100Im300)**

**Inspiration (semi-closed)**

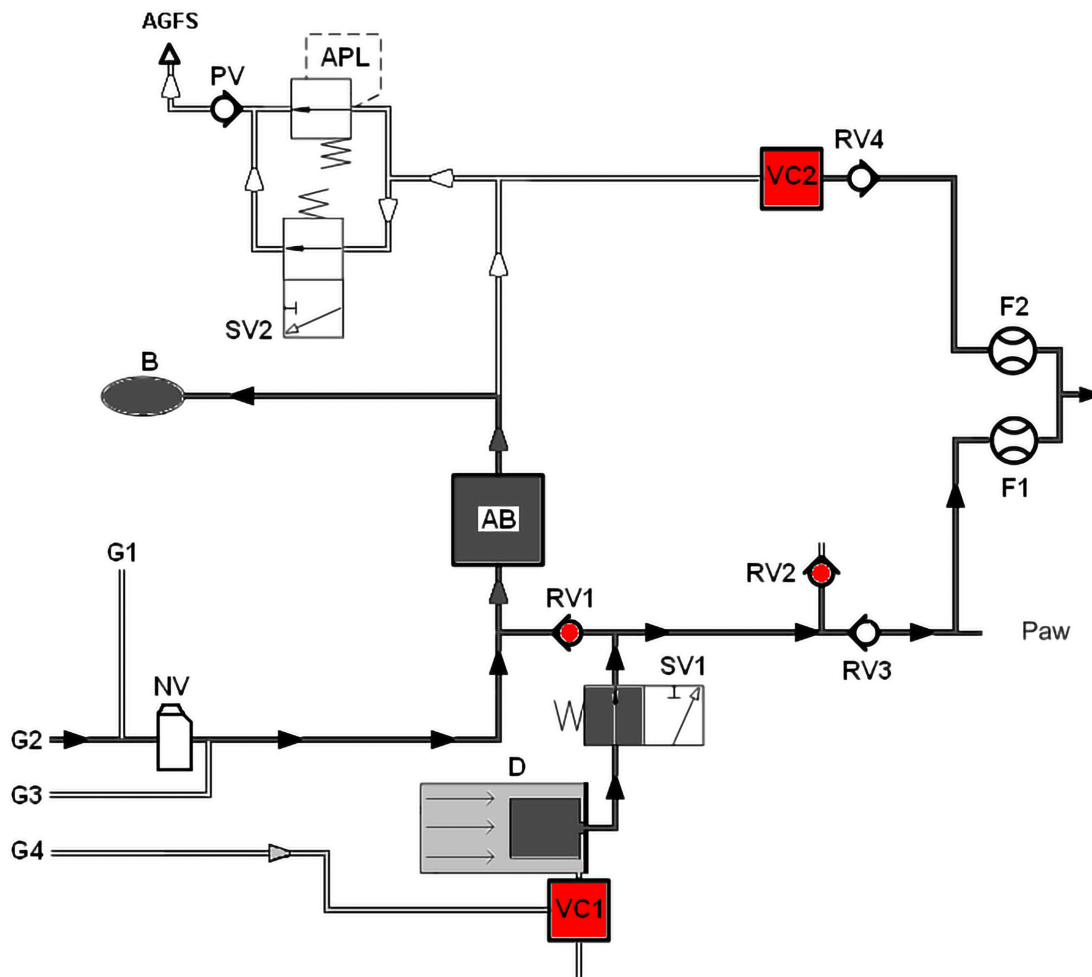

Fig. 15: Inspiration patient module Im300 (semi-closed)

**Expiration (semi-closed)**

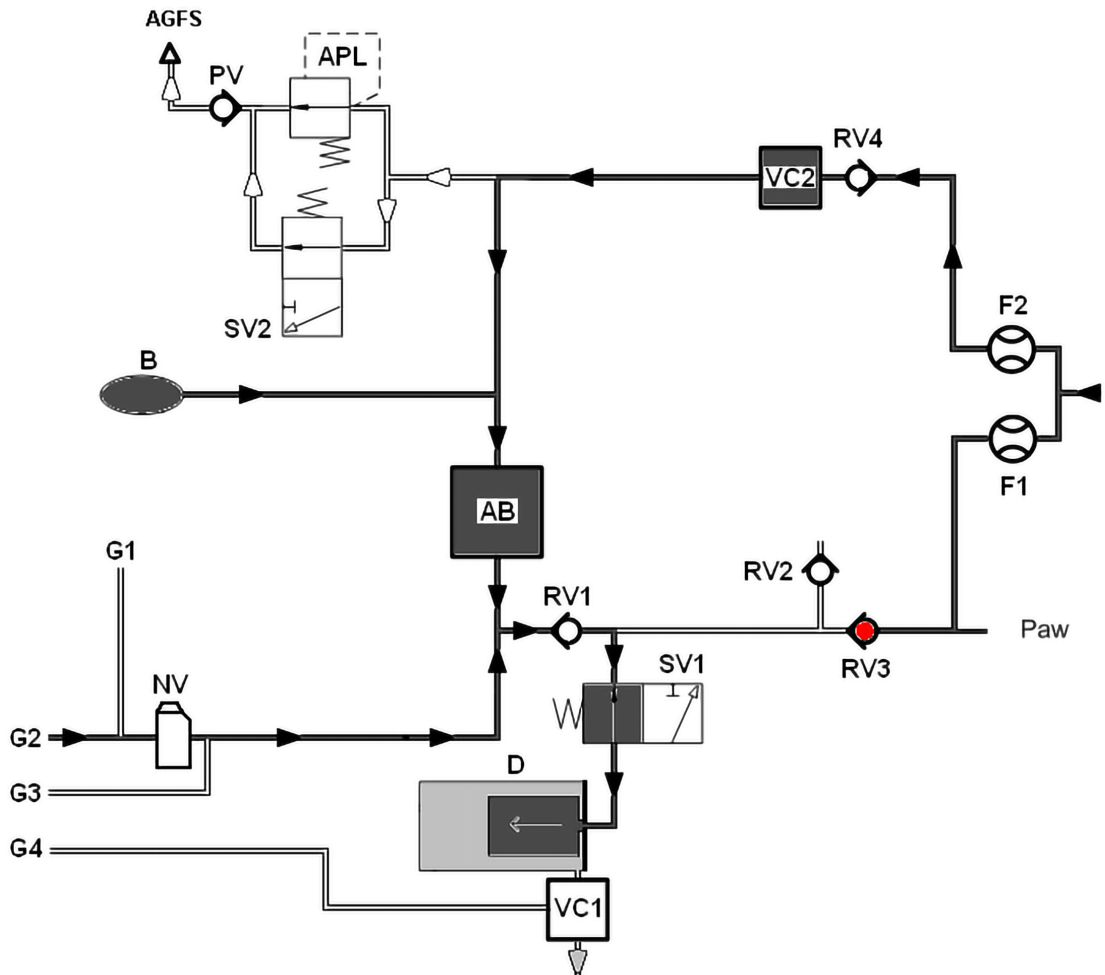

Fig. 16: Expiration patient module Im300 (semi-closed)

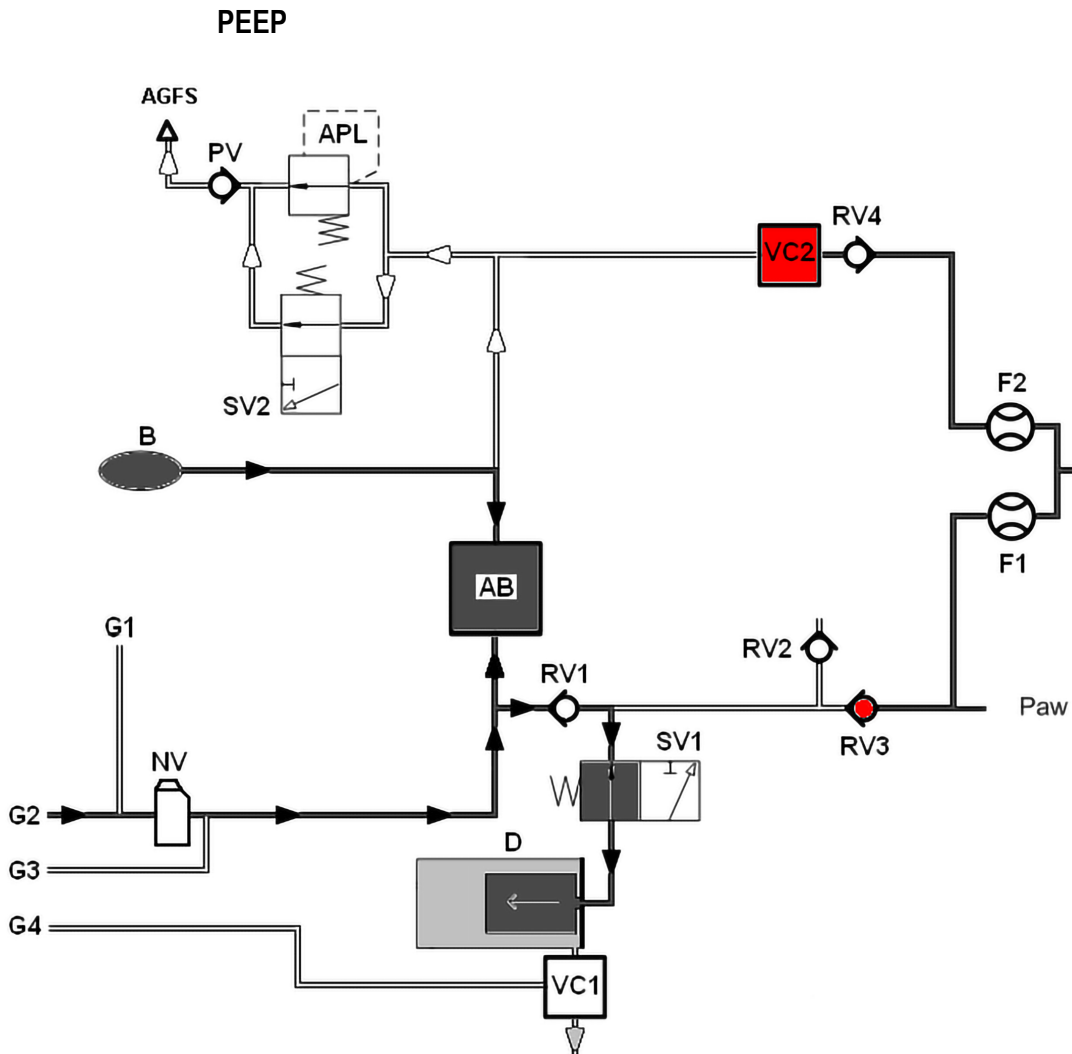

Fig. 17: PEEP patient module Im300

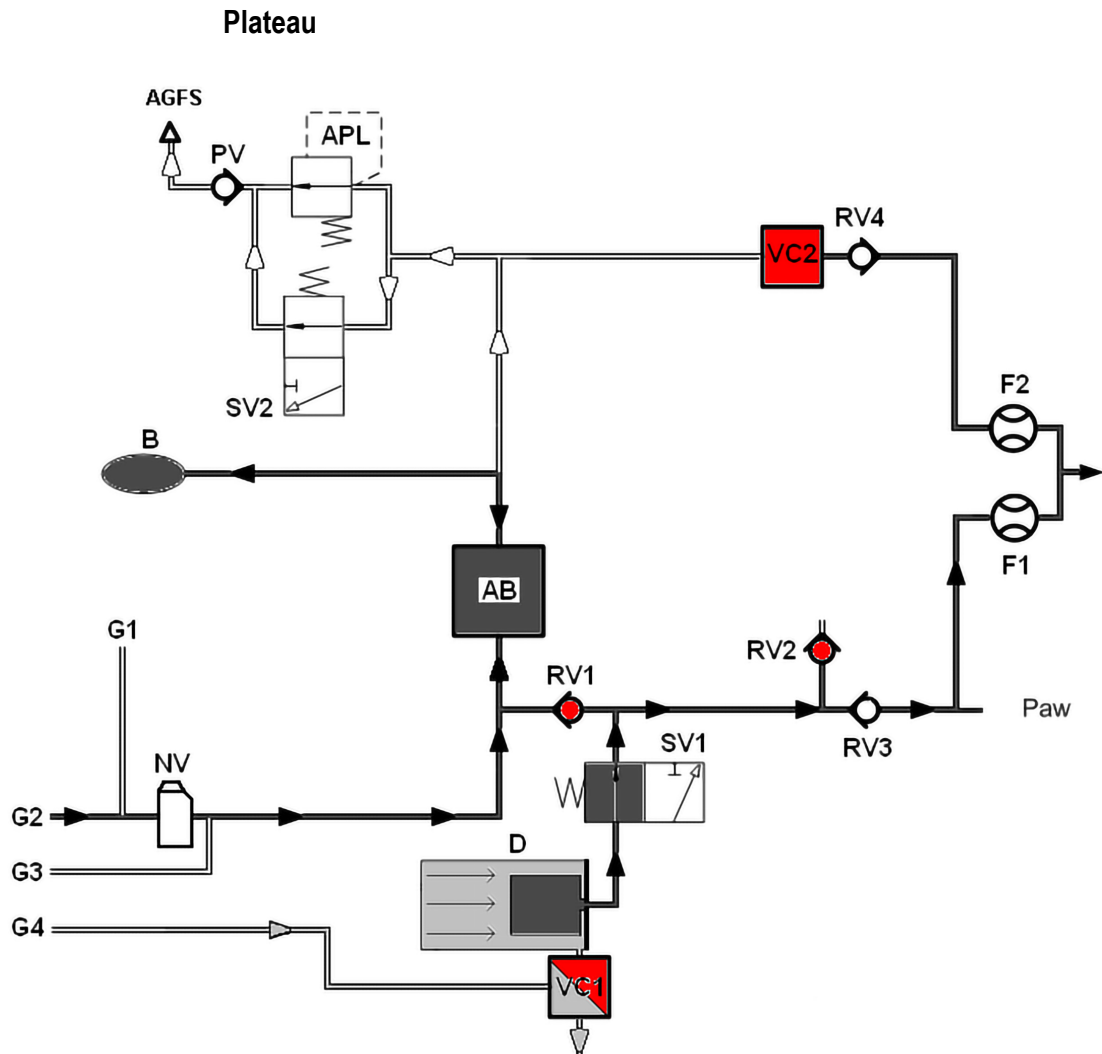

Fig. 18: Plateau patient module Im300

Calculation methods

Table 66: alveolar concentration for MAC = 1

AA	MAC <sub>40</sub> [%]
N <sub>2</sub> O	100.00
halothane	0.75
enflurane	1.70
isoflurane	1.15
sevoflurane	2.05
desflurane	6.00

$$MAC = \frac{EtAA_1[\%]}{xAA_1} + \frac{EtAA_2[\%]}{xAA_2} + \frac{EtN_2O[\%]}{xN_2O}$$

AA<sub>1,2</sub> = inhalation anaesthetic  
 Et = end-expiratory concentration  
 xAA<sub>1,2</sub> = MAC<sub>40</sub> × 10<sup>(-0.00263 × (Alter-40))</sup>

$$Freq_{Spont} = AZV_{trig} + AZV_{spont}$$

AZV<sub>trig</sub> = number of triggered, supported breaths  
 AZV<sub>spont</sub> = number of spontaneous breaths

$$\%Spont.[\%] = \frac{100 \times (AZV_{trig} + AZV_{spont})}{AZV_{trig} + AZV_{spont} + AZV_{mech}}$$

AZV<sub>trig</sub> = number of triggered, supported breaths  
 AZV<sub>spont</sub> = number of spontaneous breaths  
 AZV<sub>mech</sub> = number of mechanical breaths (untriggered)

$$Leak[\%] = \frac{MV_i - MV_e}{MV_i} \times 100$$

MV<sub>e</sub> = exp. minute volume  
 MV<sub>i</sub> = insp. minute volume

**MAC** = minimum alveolar concentration;

Definition:

minimum alveolar concentration;

MAC is the alveolar concentration of an inhalation anaesthetic to which 50% of all patients no longer react defensively to the surgical skin incision. MAC is a direct measure for the potency of an anaesthetic.

The MAC value is an empirically raised value. MAC depends on age.

The displayed minimum alveolar concentration is calculated according to the accompanying formula and only applies to patients of an age of >1 year.

(Calculation according to W. W. Mapleson)

If N<sub>2</sub>O is administered at the same time, the minimum alveolar concentration (MAC) is reduced.

**Freq<sub>Spont</sub>:**

Number of spontaneous breaths.

**%Spont.:**

Number of spontaneous breaths to the total frequency

**Leak:**

Difference between inspiratory and expiratory minute volume.

$$C \text{ (stat.)} = \frac{V_{Te} [\text{ml}]}{(P_{\text{Plat.}} [\text{mbar}] - \text{PEEP} [\text{mbar}])}$$

stat.	= static
$V_{Te}$	= expiratory mechanical breath volume
$P_{\text{Plat.}}$	= Plateau pressure

**Compliance  $C_{\text{stat.}}^1$ :**  
Lung elasticity (static)

$$C \text{ (dyn.)} = \frac{V_{Te} [\text{ml}]}{(P_{\text{Peak}} [\text{mbar}] - \text{PEEP} [\text{mbar}])}$$

dyn.	= dynamic
$V_{Te}$	= expiratory mechanical breath volume
$P_{\text{Peak}}$	= peak pressure

**Compliance  $C_{\text{dyn.}}^1$ :**  
Lung elasticity (dynamic)

$$C_{20} = \frac{V_{Ti} [\text{ml}] - V_{Ti80\%} [\text{ml}]}{(P_{\text{Plat.}} [\text{mbar}] - P_{80\%} [\text{mbar}])}$$

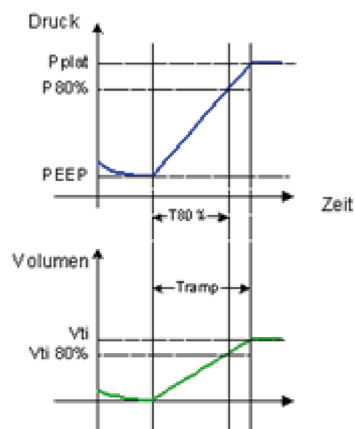

**C20:**  
Compliance during the last 20% of the inspiration phase

**C20/C<sup>1</sup>:**  
Compliance during the last 20% of the inspiration phase in relation to total compliance  
(Measurement for overdistention of the lungs)

$$R \text{ (stat.)} = \frac{(P_{\text{Plat.}} [\text{mbar}] - \text{PEEP} [\text{mbar}])}{\dot{V}_{\text{max.}} [\text{ml/s}]}$$

stat.	= static
$P_{\text{Plat.}}$	= Plateau pressure
$\dot{V}_{\text{max.}}$	= maximum expiratory flow

**Resistance<sup>1</sup>:**  
Static inspiratory resistance of the lungs and of the tube system/device

<sup>1)</sup> Is only displayed with an existing plateau.

Pressure flow characteristics

Inspiratory and expiratory pressure flow characteristics of the system to the patient connection opening

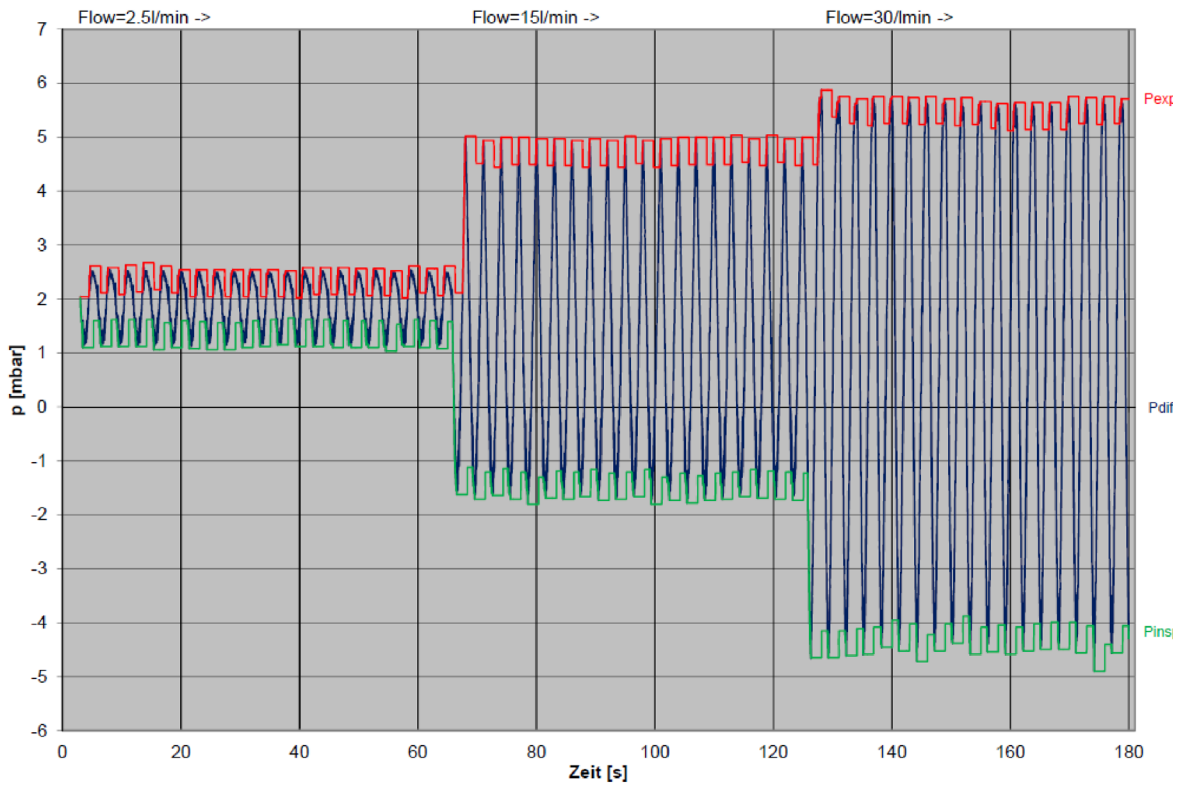



**Inspiratory and expiratory pressure flow characteristics of the absorber module of the breath circulation system**

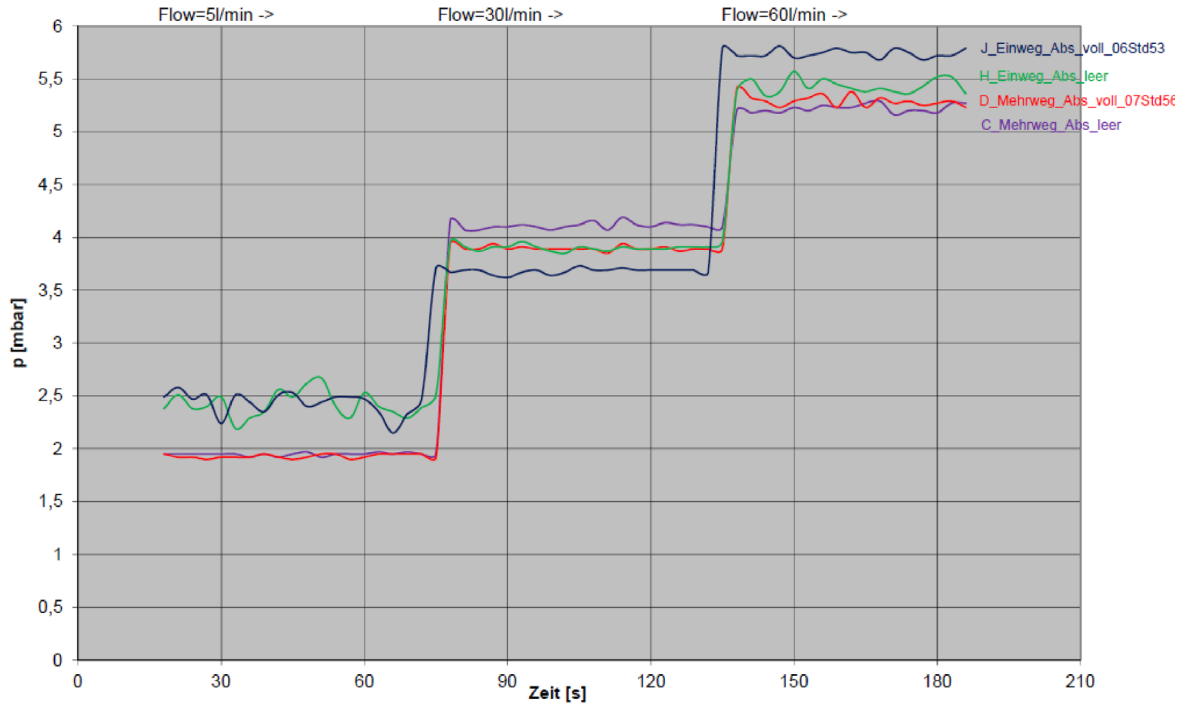

## Service life of replacement parts

### Life of soda lime

---

- change of colour of the soda lime
- increased insp. CO<sub>2</sub> Measured value

### Life of bronchial aspiration filter

---

- 2 months
- in the event of visible soiling
- slackening of aspiration performance
- damaged

### Gas measurement

---

#### Life of water trap and sample line

- 1 month
- damaged

If the water trap and sample line are not changed at the prescribed interval (monthly), the multi analyser guarantee ceases.

#### Service life of O<sub>2</sub> cell (sidestream measurement, unleaded cell)

- 10,000 hrs. @ 100% O<sub>2</sub>
- damaged

#### Service life of FiO<sub>2</sub> cell (unleaded cell)

- 20,000 hrs. @ 100% O<sub>2</sub>
- damaged

### **Life of the flow sensors**

---

- soiling that cannot be removed
- damaged

A guarantee of 1 year or a maximum of 52 executed cleaning cycles is given for the housing of the flow sensor. Damage caused by neglect is excluded from this guarantee.

No guarantee is given for damage to electrical components of the flow sensor caused by improper handling, especially during cleaning.

### **Life of the PEEP valve diaphragm**

---

- annual service
- untight
- damaged

### **Life of the insp./exp. valve diaphragms**

---

- annual service
- damaged

### **Life of the fan filter pad**

---

- annual service
- soiled
- damaged

### **Service life of reusable CO<sub>2</sub> absorber**

---

- soiling that cannot be removed
- damaged

The reusable CO<sub>2</sub> absorber is subject to a guarantee of 1 year or a maximum of 52 executed cleaning cycles. Damage caused by neglect is excluded from this guarantee.

## Service life of inspection glasses

- untight
- defective

The inspection glasses are guaranteed for 1 year or a maximum of 52 cleaning cycles. Damage caused by neglect is excluded from this guarantee.

## Lists and short instructions

### **Ordering replacement parts**

---

You can find an overview of replacement parts and consumables in the (→ *leon plus*, *leon and leon mri List of Accessories and Replacement Parts*).

### **Ordering accessories**

---

You can find an overview of optional accessories and replacement parts in the (→ *leon plus*, *leon and leon mri List of Accessories and Replacement Parts*).

### ***leon plus* Short checklist before start-up**

---

A copyable text “Short checklist before start-up” for the *leon plus* is located in the final pages of this document.

### ***leon plus* Short operating instructions**

---

A copyable text “Short operating instructions” for the *leon plus* is located in the final pages of this document.

### ***leon plus* Technical safety controls checklist**

---

A suggestion for a copyable text “Checklist of technical safety controls” for the *leon plus* is located in the final pages of this document.

## 17. Technical data

The maximum equipment of the *leon plus* is described in the technical data. For information on basic equipment and options, please contact a representative of Löwenstein Medical.

Table 67: Basic data, weight, dimensions

<b>Chassis</b>	Trolley with 4 antistatic rollers	
	Brakes	All rollers can be locked
		Central brake for all 4 rollers (optional)
	Base weight	Typically 145 kg, weight may vary acc. to equipment
	Dimensions (H x W x D) 140 x 92 x 67 cm	
	Minimum clearance width = 70 cm	
	Removable writing shelf (W x D)	43 x 30 cm
	3 drawers (H x W x D) 14 x 27 x 30 cm	
<b>Wall device</b>	Base weight 100 kg Dimensions (H x W x D) 93 x 85 x 48 cm	
<b>Wall mounting</b>	optional	
<b>Ceiling mount</b>	optional	
<b>Sound level</b>	standby 34.5 dBA, ventilation 40 dBA	
	High priority alarm	min. (50 %) 50 dBA max. (100 %) 70 dBA
	Medium priority alarm	min. (50 %) 50 dBA max. (100 %) 70 dBA
<b>Life</b>	10 years	

Table 68: Ambient conditions in operation

<b>Ambient temperature</b>	+15 °C – +35 °C
<b>Relative humidity</b>	20 – 80%, non-condensing
<b>Atmospheric pressure</b>	700 – 1060 Pa × 100

Table 69: Ambient conditions for storage and transport

<b>Ambient temperature</b>	-15 °C – +60 °C (w/o battery) -15 °C – +50 °C (with O <sub>2</sub> sensor) -15 °C – +40 °C (with battery)
<b>Relative humidity</b>	20 – 80%, non-condensing
<b>Atmospheric pressure</b>	500 – 1060 Pa × 100

Table 70: Electromagnetic compatibility

<b>Conforms to standard</b>	EN 60601-1-2:2016-05
-----------------------------	----------------------

Table 71: protection class

	I Type B in accordance with EN 60601-1
--	--

Table 72: Classification

	II b pursuant to 93/42/EEC Appendix IX
--	--

Table 73: Mains voltage and power supply

<b>Mains voltage</b>	100–240 V <sub>AC</sub> , 50/60 Hz
<b>Power consumption</b>	140 VA (including heating 20 W)
<b>Rechargeable battery supply</b>	2 x 12 V <sub>DC</sub> each with 7.2 Ah
<b>Rechargeable battery life</b>	At least 100 minutes (with fully charged batteries)
<b>Auxiliary outlets</b>	4 units, each with 2 x T 2 A fuses

Table 74: Gas connections

<b>Central gas supply</b>	Connections for O <sub>2</sub> , N <sub>2</sub> O and AIR
<b>Reserve gas bottles</b>	Connections for O <sub>2</sub> and N <sub>2</sub> O Display of reserve gas bottles pressure Permissible input pressures: O <sub>2</sub> , N <sub>2</sub> O: <5 – 200 kPa × 100 (bar)
<b>10 L bottles</b>	O <sub>2</sub> , N <sub>2</sub> O or AIR Monitoring of the supply pressures with display on the screen Permissible input pressures: O <sub>2</sub> , N <sub>2</sub> O, AIR: <5 – 200 kPa × 100 (bar)
<b>Supply pressure</b>	2.8 – 6.0 kPa × 100 (bar) Monitoring of the supply pressures with display on the screen
<b>Connection type (standard)</b>	NIST standard
<b>Aspiration</b>	Integrated vacuum source for bronchial aspiration with vacuum display

Table 75: Gas control

<b>Fresh gas producer</b>	Electronic fresh gas blender for 3 gases Selection of gas blend and flow settings via screen display
<b>O<sub>2</sub> concentration</b>	Setting range 21 – 100 vol. % with N <sub>2</sub> O as carrier gas 25 – 100 vol. % (ratio system) 100 % O <sub>2</sub> with fresh gas flow = 200 ml/min Accuracy ±5 %
<b>Fresh gas flow</b>	Setting range                      0.2 – 18 l/min 0 – 18 l/min (only HLM)  Accuracy                                <0.5 l/min ±0.05 l/min and >0.5 l/min ±10 %
<b>O<sub>2</sub> flush</b>	> 35 l/min
<b>O<sub>2</sub> emergency dosing</b>	OFF, 4, 5, 6, 7, 8, 9, 10, 12, 15 l/min
<b>Other connections</b>	Fresh gas outlet                      22 mm external/15 mm internal ISO cones  Ext. O <sub>2</sub> outlet                         22 mm external/15 mm internal ISO cones



Table 76: Patient module

<b>Conforms to standard</b>	DIN EN ISO 80601-2-13	
<b>Circuit system</b>	Fresh gas decoupled, heated Complete, with absorber container (can be changed during operation) Inspiratory and expiratory flow measurement, decoupled APL	
<b>Ventilation system</b>	All components completely latex-free	
<b>Patient connections</b>	22 mm external/15 mm internal ISO cones	
<b>Dimensions W x H x D</b>	190 mm, 70 mm, 365 mm (height without APL)	
<b>Weight</b>	without absorber	9.3 kg
<b>Volume</b> (without ventilation tubes and bag, with absorber)	MAN/SPONT form of ventilation	approx. 2.6 l
	in mechanical ventilation	approx. 5.3 l
<b>Compliance</b> (without ventilation tubes and bag, with absorber)	MAN/SPONT form of ventilation	approx. 2.6 ml/Pa × 100
	in mechanical ventilation	approx. 5.3 ml/Pa × 100
<b>Leakage</b>	Conforms to DIN EN ISO 80601-2-13 < 150 ml/min at 30 Pa × 100 (mbar)	
<b>exp./insp. resistance</b> with 2.5 l/min with 15 l/min with 30 l/min	Conforms to DIN EN ISO 80601-2-13	
	2.5 Pa × 100	
	5.0 Pa × 100	
	5.4 Pa × 100	

Table 77: APL valve

<b>Setting range</b>	Spontaneous breathing and adjustable ventilation pressures up to at least max. settings with perceptible screening	
	<ul style="list-style-type: none"> <li>▪ APL without quick exhaust max. setting 90 Pa × 100 (mbar)</li> <li>▪ APL with quick exhaust max. setting 80 Pa × 100 (mbar)</li> </ul>	
	Accuracy	± 10 Pa × 100 (mbar) or max. ±15%

Table 78: Anaesthetic vaporiser mounting

<b>Connection type</b>	Selectatec® or Dräger-compatible anaesthetic vaporiser mounting for 2 interlock-compatible anaesthetic vaporisers
------------------------	---

Table 79: CO<sub>2</sub> absorber

<b>Dimensions</b>	Ø 140 mm height 265 mm	
<b>Weight</b>	550 g	
<b>Material</b>	Polisulfon/PBT	
<b>Volume</b>	2000 ml (fillable 1750 ml)	
<b>Guarantee</b>	1 year or max. 52 cleaning cycles	
<b>Material specification for sensitive absorbers</b>	SofnoLime:	3 wt. % sodium hydroxide 75 wt. % sodium hydroxide White or coloured solids pH value 12 – 14
	Sodasorb:	2 wt. % sodium hydroxide 80 wt. % sodium hydroxide White or coloured solids pH value 12 – 14
	Spherasorb:	>2 wt. % sodium hydroxide 75 – 80 Gew.-% calcium hydroxide White, firm balls pH value alkaline solution

Table 80: Anaesthetic ventilator

<b>Conforms to standard</b>	DIN EN ISO 80601-2-13	
<b>Ventilator</b>	Pneumatically driven and electronically controlled hanging bellows pressure-limited compliance-compensated	
<b>Drive gas consumption</b>	≥minute volume MV	
<b>Accuracy of drive gas generator</b>	Volume	up to 150 ml ±10 % min. ±10 ml from 150 ml ±5 % min. ±15 ml
	frequency	±10 % of set value or ±1

Table 80: Anaesthetic ventilator

<b>Screen</b>	15" TFT display, touchscreen
<b>Graphic displays</b>	Selection of display of 4 real-time curves at the same time Complete data management with trend display
<b>Curve display</b>	Pressure Flow Volume O <sub>2</sub> CO <sub>2</sub> N <sub>2</sub> O Volatile anaesthetics
<b>Respirator settings</b>	2 volume-controlled forms ventilation (IMV, S-IMV) 2 pressure-controlled forms ventilation (PCV, S-PCV) 1 pressure/flow-controlled form of ventilation (PSV) 1 heart-lung machine form of ventilation (HLM) 1 manual ventilation/spontaneous breathing (MAN/SPONT) 1 monitoring (MON)
<b>Inspiratory flow</b>	maximum 180 l/min
<b>MV</b>	maximum 30 l/min

Table 81: IMV volume-controlled ventilation

<b>V<sub>Ti</sub> tidal volume</b> Numerical values in brackets: optional	20 (3) – 600 ml (children) 300 – 1600 ml (adults) 20 (3) – 1600 ml (IBW)
<b>Ventilation frequency</b> Numerical values in brackets: optional	14 – 80 (100) 1/min (children) 4 – 40 1/min (adults) 4 – 80 (100) 1/min (IBW)
<b>I:E ratio</b>	1:4 – 4:1 (incremental 0.1)
<b>PEEP</b>	OFF, 1 – 20 Pa × 100 (mbar)
<b>Plateau</b>	OFF, 10 – 50% (incremental 10%)
<b>Pressure limitation (P<sub>max</sub>)</b>	10 – 80 Pa × 100 (mbar)

Table 82: Volume-controlled synchronised ventilation S-IMV

<b>V<sub>Ti</sub> tidal volume</b> Numerical values in brackets: optional	20 (3) – 600 ml (children) 300 – 1600 ml (adults) 20 (3) – 1600 ml (IBW)
<b>Inspiration time T<sub>insp.</sub></b>	0.2 – 2.9 s (children) 0.3 – 10 s (adults) 0.2 – 10 s (IBW)
<b>Ventilation frequency</b>	6 – 60 1/min (children) 4 – 40 1/min (adults) 4 – 60 1/min (IBW)
<b>PEEP</b>	OFF, 1 – 20 Pa × 100 (mbar)
<b>Plateau</b>	OFF, 10 – 50% (incremental 10%)
<b>Pressure limitation (P<sub>max</sub>)</b>	10 – 80 Pa × 100 (mbar)
<b>Trigger threshold</b>	0.1 – 10 l/min

Table 83: Pressure-controlled ventilation PCV

<b>Ventilation frequency</b> Numerical values in brackets: optional	14 – 80 (100) 1/min (children) 4 – 40 1/min (adults) 4 – 80 (100) 1/min (IBW)	
<b>I:E ratio</b>	1:4 – 4:1 (incremental 0.1)	
<b>Plateau</b>	10 – 90 % (incremental 5%)	
<b>Ventilation pressure P<sub>insp.</sub></b>	5 – 60 Pa × 100 (mbar)	
<b>PEEP</b>	OFF, 1 – 20 Pa × 100 (mbar)	
<b>Volume guarantee V<sub>TG</sub> (optional)</b> Numerical values in brackets: optional	V <sub>TG</sub> tidal volume	OFF, 20 (3) – 600 ml (children) OFF, 300 – 1600 ml (adults) OFF, 20 (3) – 1600 ml (IBW)
	Pressure limitation (P <sub>max</sub> )	5 – 60 Pa × 100 (mbar)

Table 84: Pressure-controlled synchronised ventilation S-PCV

<b>Ventilation pressure <math>P_{max}</math></b>	5 – 60 Pa × 100 (mbar)
<b>Inspiration time <math>T_{insp.}</math></b>	0.2 – 2.9 s (children) 0.3 – 10 s (adults) 0.2 – 10 s (IBW)
<b>Ventilation frequency</b>	6 – 60 1/min (children) 4 – 40 1/min (adults) 4 – 60 1/min (IBW)
<b>PEEP</b>	OFF, 1 – 20 Pa × 100 (mbar)
<b>Plateau</b>	10 – 90 % (incremental 5%)
<b>Trigger threshold</b>	0.1 – 10 l/min

Table 85: Pressure-supported spontaneous breathing PSV (ASSIST)

<b>Supporting pressure <math>P_{insp.}</math></b>	5 – 60 Pa × 100 (mbar) (adults and children)
<b>PEEP</b>	OFF, 1 – 20 Pa × 100 (mbar)
<b>Trigger threshold</b>	0.1 – 10 l/min
<b>Backup</b>	4, 6, 8, 10, 15, 30, 45 seconds

Table 86: MAN/SPONT manual ventilation

<b>Ventilation bag</b>	Manual ventilation is produced with the ventilation bag, which serves as a reservoir
	Display of apnoea duration

Table 87: Ventilation using a heart-lung machine HLM

<b>Ventilation bag</b>	Manual ventilation is produced with the ventilation bag, which serves as a reservoir
	CPAP via APL
	Fresh gas settings at 0 l/min possible

Table 88: Monitoring mode MON

	Monitoring mode for adequately spontaneously breathing patients
	Freq. <sub>CO2</sub> alarm

Table 89: Safety equipment

<b>Minimum concentration O<sub>2</sub></b>	Electronic control of the fresh gas setting so that in an O <sub>2</sub> /N <sub>2</sub> O gas blend, an O <sub>2</sub> concentration of 25% cannot be exceeded. O <sub>2</sub> fresh gas (100%) of at least 200 ml/min is guaranteed (except for HLM) N <sub>2</sub> O block in the event of O <sub>2</sub> shortage
<b>Safety valves</b>	Valves with adjustable pressure relief Automatic safety valve that prevents high-pressure hazards Automatic safety valve that prevents low-pressure hazards
<b>Gas type check</b> (can be activated in the service)	CGS O <sub>2</sub> , N <sub>2</sub> O, AIR,

Table 90: Ventilation monitoring

<b>Airway pressure</b>	Peak, medium, PEEP, Plateau, CPAP
	Type Piezo-resistant
	Range -10 – 100 Pa × 100 (mbar)
	Accuracy ±4 % min. 2 Pa × 100 (mbar)
	Resolution of displays 1 mbar
<b>Tidal volumes V<sub>Ti</sub>, V<sub>Te</sub></b>	Range 0 – 5000 ml
	Accuracy of displays ±10 % or 5 ml
	Resolution 1 ml
<b>Minute volume</b>	Range 0 – 50 l
	Accuracy of displays ±10 % or 50 ml
	Resolution 10 ml
<b>Frequency (spontaneous)</b>	Range 0 – 150 1/min
	Accuracy ± 1/min
	Resolution of displays 1/min

Table 90: Ventilation monitoring

<b>Flow measurement</b>	Type	Hot-wire anemometry
	Range	-200 – 200 l/min
	Accuracy	±10 %
	Resolution of displays	0.1 l/min
<b>Lung function</b>	Static/dynamic compliance	
	C20/C	
	Resistance	
	Loops	
<b>Other</b>	Spontaneous breathing rate, share of spontaneous breaths, inspiration time of spontaneous breaths, $T_{\text{insp.}}$ , $T_{\text{exp.}}$ , I:E, MV, $O_2$ effective	

Table 91: Gas supply monitoring

<b>CGS pressure</b>	Type	Piezo-resistant
	Range	0 – 10 kPa × 100 (bar)
	Accuracy	±3 % min. 0.1 Pa × 100 (mbar)
	Resolution of displays	0,1 kPa × 100 (bar)
<b>Bottle pressure</b>	Type	Metallic thin-film sensor
	Range	0 – 250 kPa × 100 (bar)
	Accuracy	±4 % or 2 kPa × 100 (bar)
	Resolution of displays	1 kPa × 100 (bar)

Table 92: Standard specifications (full accuracy)

Gas	Concentration <sup>1)</sup> [%rel]	Deviation <sup>2), 3)</sup> [%abs]	Interference <sup>4), 5)</sup> [%abs]
<b>CO<sub>2</sub></b>	0 – 1	±0.1	N <sub>2</sub> O 0.1 O <sub>2</sub> 0.1 each agent 0.1 <sup>6)</sup>
	1 – 5	±0.2	
	5 – 7	±0.3	
	7 – 10	±0.5	
	>10	Not specified	
<b>N<sub>2</sub>O</b>	0 – 20	±2	CO <sub>2</sub> 0.1 O <sub>2</sub> 0.1 each agent 0.1 <sup>6)</sup>
	20 – 100	±3	
<b>HAL<sup>9)</sup>, ENF<sup>9)</sup>, ISO<sup>9)</sup></b>	0 – 1	±0.15	CO <sub>2</sub> 0 N <sub>2</sub> O 0.1 O <sub>2</sub> 0.1 2, agent 0.1 (typical) <sup>7)</sup>
	1 – 5	±0.2	
	>5	Not specified	
<b>SEV<sup>9)</sup></b>	0 – 1	±0.15	CO <sub>2</sub> 0 N <sub>2</sub> O 0.1 O <sub>2</sub> 0.1 2, agent 0.1 (typical) <sup>7)</sup>
	1 – 5	±0.2	
	5 – 8	±0.4	
	>8	Not specified	
<b>DES<sup>9)</sup></b>	0 – 1	±0.15	CO <sub>2</sub> 0 N <sub>2</sub> O 0.1 O <sub>2</sub> 0.1 2, agent 0.1 (typical) <sup>7)</sup>
	1 – 5	±0.2	
	5 – 10	±0.4	
	10 – 15	±0.6	
	15 – 18	±1	
	>18	Not specified	
<b>O<sub>2</sub> Hummingbird PM1111E (optional)</b>	0 – 25	±1	CO <sub>2</sub> 0.2 O <sub>2</sub> 0.2 each agent 1.0
	25 – 80	±2	
	80 – 100	±3	
<b>O<sub>2</sub> OXIMA™ (optional)</b>	0 – 40	± (1% <sub>abs</sub> + 1% <sub>rel</sub> )	0.3 <sup>8)</sup>
	40 – 60	± (1% <sub>abs</sub> + 2% <sub>rel</sub> )	
	60 – 80	± (1% <sub>abs</sub> + 3% <sub>rel</sub> )	
	80 – 100	± (1% <sub>abs</sub> + 4% <sub>rel</sub> )	



**Notes**

- (1) Gas data are shown as zero, if the measured concentration is more than three s under the established threshold level: CO<sub>2</sub> -0.1/0.3 %; N<sub>2</sub>O -3.3 %; O<sub>2</sub> -0/0 %, Agent -0.15/0.3 % (full/ISO accuracy).
- (2) Using a DRYLINE™ sampling system, the inaccuracy at 10 – 55°C operating temperature is specified and is compensated by H<sub>2</sub>O partial pressure of 11 mbar as standard (i.e. 22 °C at 40% relative humidity ambient conditions). For the automatic compensation of the effect of ambient humidity on the gas sample composition, the actual H<sub>2</sub>O ambient partial pressure of the host can be given via the communication interface of the AION™.
- (3) Specifications of the inaccuracy comprise stability and drift.
- (4) Maximum interference by each gas at concentrations within the specified accuracy for each gas.
- (5) Multiple faults on CO<sub>2</sub>, N<sub>2</sub>O and O<sub>2</sub> are usually the same as individual faults.
- (6) For AION™ 03, 02 and 01 ERP: Required entry of the agent used.
- (7) Applies only to AION™ 03, 02 and 01 ERP
- (8) Maximum interference for gas concentrations up to 5% CO<sub>2</sub>, 80% N<sub>2</sub>O (bal N<sub>2</sub>), 5% HAL, 5% ISO, 5% ENF, 8% SEV, 18% DES.
- (9) Not applicable to AION™ 01.

Table 93: Extended specifications<sup>1, 2, 3, 4)</sup> (full accuracy)

Gas	Range [% <sub>rel</sub> ]	Deviation [% <sub>abs</sub> ]	Static [% <sub>abs</sub> ] <sup>5)</sup>	Interference [% <sub>abs</sub> ] <sup>6)</sup>
ISO	<5	p. spec. normal range	--	--
	5 – 6	±0.2	0.05	--
	6 – 10	±0.6	0.1	N <sub>2</sub> O + O <sub>2</sub> 0.4
	10 – 15 <sup>7)</sup>	±2.0	0.22	2. Agent Not specified
	>15	Not specified	Not specified	
SEV	<8	p. spec. normal range	--	--
	8 – 12	±0.6	0.09	--
	12 – 16	±1.0	0.12	N <sub>2</sub> O + O <sub>2</sub> 0.4
	16 – 20 <sup>7)</sup>	±2.0	0.17	2. Agent Not specified
	20 – 24 <sup>7)</sup>	±2.5	0.24	
>24	Not specified	Not specified		
DES	<18	p. spec. normal range	--	--
	18 – 24	±2.2	0.44	--
	24 – 30 <sup>7)</sup>	-2.2/+6.0	0.86	N <sub>2</sub> O + O <sub>2</sub> 0.4
	30 – 32 <sup>7)</sup>	-2.2/+8.0	1.10	2. Agent Not specified
	>32	Not specified	Not specified	

Table 94: Extended range pressure effects <sup>8)</sup>

	[% <sub>abs</sub> ]			
	@ 700 hPa	@ 850 hPa	@ 1013 hPa	@1100 hPa
@ 7.5 % ISO	-0.0 +0.6	-0.0 +0.2	See table above	-0.1 +0.2
@ 13 % SEV	-0.0 +0.2	-0.0 +0.3		-0.3 +0.0
@ 15 % DES	-1.0 +0.0	-0.5 +0.0		-0.0 +0.5

**Notes**

- (1) Extended specification not valid if in ISO mode
- (2) At ambient pressure of 1013 hPa
- (3) Extended range must be set with a special command, which also requires the entry of the used agent. NOTE: If the wrong agent is entered, the accuracy specification is invalid.
- (4) CO<sub>2</sub> and N<sub>2</sub>O data are not valid if the extended range is activated.
- (5) Typical static specification. Static is calculated as the standard deviation from 600 sample values (80 ms interval).
- (6) Interference is added to the specification of accuracy.
- (7) Ranges above 10% ISO, 16% and 24% SEV DES are not intended for normal or continuous operation but only for error conditions.
- (8) Ambient pressure effects are specified for 1.5 times the normal range of the maximum concentrations (except for DES). The effects are added to the specification of inaccuracy. Ambient pressure effects increase with increasing gas concentration and are specified for 1.5 times the normal range.

Table 95: Interference due to gas contamination

Contamination	Interference [% <sub>abs</sub> ]				
	CO <sub>2</sub>	N <sub>2</sub> O	Agents	O <sub>2</sub> Hummingbird PM1111E (optional)	O <sub>2</sub> OXIMA™ (optional)
<100 % Xenon	0.1	0	0	0.5	0.3
<50 % He	0.1	0	0	0.5	0.3
Drive gas-operated dosing aerosol	Not specified	Not specified	Not specified	0.5	Not specified
<0.1% ethanol	0	0	0	0.5	0.3
Saturated isopropanol steam	0.1	0	Not specified	0.5	Not specified
<1% acetone	0.1	0.1	0	0.5	0.3
<1% methane	0.1	0.1	0	0.5	0.3

Table 96: Gas measurement

<b>FiO<sub>2</sub></b>	<b>Optional</b>	Inspiratory fuel cell
<b>Sidestream measurement</b>		standard
	<b>O<sub>2</sub></b>	Measurement paramagnetic or fuel cell inspiratory/expiratory
	<b>CO<sub>2</sub></b>	Measurement infrared spectrometry inspiratory/end-tidal
	<b>N<sub>2</sub>O</b>	Measurement infrared spectrometry inspiratory/end-tidal
	<b>Anaesthetic gases</b>	Measurement infrared spectrometry inspiratory/end-tidal Halothane, enflurane, isoflurane, sevoflurane and desflurane Auto ID

Table 96: Gas measurement

<b>Limits for precise triggered breathing rate</b>		60 1/min
<ul style="list-style-type: none"> <li>▪ based on end-expiratory values values</li> <li>▪ for I:E ratio 1:1</li> </ul>		<ul style="list-style-type: none"> <li>▪ at 200 ml/min for watertrap variant DRYLINE™ watertrap/gas sample tube for adults</li> <li>▪ at 120 ml/min for watertrap variant DRYLINE™ for neonates with gas sample tube for neonates and watertrap variant LM Watertrap</li> </ul>
<b>Rise time (t<sub>10-90%</sub>) @ 120 ml/min</b>	<b>CO<sub>2</sub></b>	250 ms (fall time 200 ms)
	<b>N<sub>2</sub>O</b>	250 ms
	<b>O<sub>2</sub></b>	600 ms
	<b>HAL, ISO, SEV, DES</b>	300 ms
	<b>ENF</b>	350 ms
<b>Rise time (t<sub>10-90%</sub>) @ 200 ml/min</b>	<b>CO<sub>2</sub></b>	250 ms (fall time 200 ms)
	<b>N<sub>2</sub>O</b>	250 ms
	<b>O<sub>2</sub></b>	500 ms
	<b>HAL, ISO, SEV, DES</b>	300 ms
	<b>ENF</b>	350 ms
<b>Delay time</b>		<4 s
<b>Flow</b>	<b>Adults</b>	120 – 200 ml/min
	<b>Neonates</b>	70 – 120 ml/min
<b>Blockage alarm</b>		Flow <40 ml/min
<b>Watertrap full</b>		Flow <75 % of the set flow
<b>Duration of zero phase</b>		5 s, maximum 9 s every 4 hours
<b>Accuracy</b>		ISO (11196) after 45 s, full after 10 min
<b>Rated value of breathing rate</b>		2 – 100 1/min
<b>MAC</b>		Establishment of the minimum alveolar concentration

Table 97: Interfaces

<b>Serial</b>	COM1, COM2 D--SUB, socket (standard, 9--pin) galvanically separated, 3 kV
<b>Ethernet</b>	IEE 802.3, 100BaseT, CAT5
<b>USB</b>	1.0
<b>FO</b>	LC socket (optional)

Table 98: protocols

<b>Phillips VueLink</b>	COM1
<b>Philips Intellibridge</b>	COM1
<b>HuLBus</b>	COM2
<b>HL7</b>	Ethernet
<b>USB</b>	Update, Logfiles
<b>FO</b>	Mirror UI on external screen

Table 99: Relevant standards

<b>93/42/EEC</b>	Council Directive dated 14 June 1993 on medical products
<b>DIN EN 60601-1</b>	Medical electrical devices – Section 1: General specifications for safety including essential performance features (IEC 60601-1:2005 + Cor.:2006 + Cor.:2007 + A1:2012); German edition EN 60601-1:2006 + Cor.:2010 + A1:2013
<b>DIN EN 60601-1-2</b>	Medical electrical devices – Section 1 – 2: General specifications for safety including essential performance features – extended standard: Electromagnetic compatibility – requirements and tests (IEC 60601-1-2:2007, modified); German edition EN 60601-1-2:2007
<b>DIN EN ISO 80601-2-13</b>	Medical electrical devices – Section 2 – 13: General specifications for safety including essential performance features – anaesthesia workstations: (ISO 80601-2-13:2011); German edition EN ISO 80601-2-13:2012
<b>DIN EN ISO 80601-2-55:2018</b>	Medical electrical devices – Section 2-55: General specifications for safety including essential performance features of monitoring devices for patient gases (ISO 80601-2-55:2018)

## 18. Index

- %Spont..... 312
- About this User manual ..... 15
- Accessories ..... 286
- Active configuration after system start-up . 117
- Adjustable alarm limits ..... 208
- AGSS..... 11, 22, 65, 69, 87, 88, 89, 144, 254, 289, 293
- AIR
  - as drive gas ..... 74, 195, 197
- alarm
  - active..... 212
  - alarm log ..... 133, 206
  - function test ..... 134
  - messages ..... 178, 214
  - muting ..... 54, 178, 204
    - 10 minutes..... 205
    - 2 minutes..... 204
  - priorities ..... 201
  - test ..... 133
  - types ..... 201
  - volume ..... 202
- Alarm ..... 200
  - Alarm log..... 46
  - Messages ..... 214
- alarm limits
  - adjust ..... 211
  - automatically followed..... 212
  - autoset ..... 211
- Alarm volume ..... 114
- ambient conditions
  - adaptation ..... 68
- Anaesthesia systems ..... 23
- anaesthetic vaporiser ..... 14
- Anaesthetic vaporiser . 59, 148, 149, 150, 151, 160, 280, 288, 293
- Anaesthetic vaporiser mounting ..... 31
- Anaesthetic vaporisers ..... 90
- APL valve ..... 67, 90, 149
- Appendix ..... 290
- Application area and increment of alarm... 209
- Assessment and documentation ..... 284
- Authorities
  - Messages ..... 19
- Auxiliary devices..... 287
- Back to the system test from standby ..... 127
- Basic screen..... 49
- battery
  - charging ..... 70
  - operation..... 70
- Battery ..... 70, 178, 199, 252
  - charge ..... 199
  - failure ..... 199
  - low..... 199
  - not connected..... 199
  - operation ..... 78
  - Operation ..... 199
- Battery ..... 70
- Before cleaning and disinfection 265, 266, 267
- Borderline fresh gas settings ..... 148
- Bronchial aspiration ..... 67, 91, 288
- Buttons
  - ventilation parameters setting ..... 48
- Calculated values ..... 180
- Calculation methods ..... 312
- Calibrate
  - O2 cell ..... 276
- calibration
  - side power measurement..... 277
- Calibration
  - Calibrate ..... 276
  - Sidestream measurement
    - Execution ..... 278
    - Test setup..... 277
- change
  - bronchial aspiration filter ..... 262
  - CO<sub>2</sub> absorber ..... 262
  - flow sensors ..... 265
  - insp./exp. valve diaphragms ..... 267
  - PEEP setting
    - behaviour of the P<sub>insp.</sub> Setting ..... 143
- Change
  - 10 L bottles..... 270
  - Reserve gas bottles ..... 270
- Change password..... 110
- changing
  - 10 L bottles..... 274
  - reserve gas bottles..... 274
- check
  - 10 L cylinders ..... 269
  - reserve gas cylinders ..... 269
- checklist
  - technical safety controls..... 284, 319
- Classification of the device ..... 21
- cleaning
  - high-pressure regulator ..... 271
- Cleaning..... 271
- CO<sub>2</sub> absorber
  - removing and installing ..... 79
- CO<sub>2</sub> absorber ..... 64, 66, 198, 266, 280, 293
  - change ..... 80
  - empty ..... 80
  - fill 80
- Colour concept..... 48
- Compliance ..... 11, 180, 245, 313
- Compliance compensation ..... 140
- Concepts..... 47

- Config..... 96
- configuration
  - during ventilation ..... 100
  - fresh gas blender ..... 103
  - monitoring
    - calculated value I..... 105
    - ventilation measured value..... 105
- Configuration
  - form of ventilation ..... 105
  - in standby ..... 96
  - limit values ..... 104
  - store ..... 117
- Configuration tab/page 1 ..... 111
- Configuration tab/page 2 ..... 115
- connection
  - AGSS ..... 65
  - AGSS
    - on rear ..... 65
  - AGSS
    - to patient module ..... 87
  - auxiliary devices ..... 92
  - bronchial aspiration ..... 91
  - CO<sub>2</sub> absorber ..... 66
  - data communication ..... 93
  - dome ..... 66, 79
  - flow sensors ..... 66
  - PEEP valve diaphragm cover ..... 66
  - respiratory bellows ..... 66, 79
  - ventilation bag ..... 65, 86
  - ventilation tubes ..... 65
  - workstation light ..... 78
- Connection
  - 10 L bottles ..... 76
    - as reserve gas bottles ..... 75
  - 10 L bottles instead of CGS ..... 74
  - AGSS ..... 87
  - AGSS
    - on rear ..... 88
  - AIR ..... 76
  - CGS ..... 72, 76
  - electric devices ..... 77
  - equipotential bonding ..... 78
  - external high-pressure gas outlets ..... 77
  - mains ..... 77
  - Patient adapter ..... 85
  - reserve gas bottles
    - 2l ..... 73
    - 3l ..... 73
  - Sample line ..... 85
  - vacuum ..... 77
  - ventilation tubes ..... 82
  - Watertrap ..... 84
- Contraindications ..... 23
- Control elements
  - Monitoring calculated values I..... 185
  - Monitoring ventilation ..... 185
- Control elements ..... 55
- data ..... 50
  - as trend curves ..... 180
- Data ..... 133, 176
  - as real-time curves ..... 179
- Date ..... 99
- Decommissioning
  - 10 L gas cylinders ..... 71
  - Reserve gas cylinders ..... 71
- defined safe state
  - failsafe ..... 236
  - Patientsafe ..... 235
- Defined safe state ..... 235
- Delivery contents ..... 35
- description
  - device connections ..... 59
  - forms of ventilation ..... 162
- Description
  - Options ..... 16
- desflurane ..... 22
- Detection of triggered breaths ..... 190
- device
  - check ..... 118
  - functions ..... 178
- Device
  - connections ..... 59
  - description ..... 29
  - Overview ..... 22
- Device rails ..... 32
- DGAI
  - Short check ..... 95
- disinfection
  - high-pressure regulator ..... 271
- Disinfection ..... 271
- dismantling
  - flow sensors ..... 265
  - insp./exp. valve diaphragms ..... 267
  - PEEP valve diaphragm ..... 266
- display
  - apnoea duration ..... 208
  - compliance ..... 128, 129
  - current alarms ..... 200
  - damaged fresh gas blender ..... 194
  - leakage rate ..... 128, 129
- Display
  - alarms on the screen ..... 200
  - Lock ..... 173
  - Trend curves ..... 181
- Displays ..... 55
- disposal
  - battery ..... 274
  - bronchial aspiration filter ..... 272
  - electric and electronic components ..... 273
  - fan filter pad ..... 273
  - flow sensors ..... 273
  - gas ..... 272
  - O<sub>2</sub> sensor ..... 273
  - sample line ..... 272
  - soda lime ..... 272
  - valve diaphragm ..... 273



- water trap ..... 272
- Disposal..... 272, 273
- Docking station with patient module..... 198
- Drawers ..... 33
- Drive gas generator..... 197, 243
- Econometer ..... 147
  - Limits..... 112
- Electrical safety ..... 280, 281
- Electromagnetic environment
  - Guidelines..... 26
- Emergency power supply ..... 70
- enflurane ..... 22
- Entry of age for MAC calculation..... 189
- error search
  - circulation system ..... 245
  - flow sensors ..... 244
  - fresh gas blender ..... 241
  - gas supply..... 239
  - gas type check..... 240
  - respirator..... 243
  - self check..... 239
  - system test..... 240
- Error search
  - Circulation system ..... 247
  - FiO<sub>2</sub> calibration ..... 248
- Errors and measures..... 233
- Essential information covered by the instruction manual..... 15
- Event log..... 46, 183
- example
  - setting limit fresh gas shortage and economic consumption ..... 113
  - setting limit fresh gas shortage and uneconomic consumption ..... 113
- execution
  - system test..... 127, 149
- expiration
  - manual ..... 295, 301, 307
- Expiration (semi-closed)..... 297, 303, 309
- Extended monitor ..... 49
- external fresh gas outlet
  - before the system test ..... 125
- External fresh gas outlet..... 41, 59, 60
- External O<sub>2</sub> outlet..... 41, 59, 60
- Factory settings of the alarms ..... 202
- Failsafe ..... 238
- failure
  - AGSS..... 254
    - measures ..... 254
    - reaction of the system ..... 254
  - central gas supply
    - measures ..... 252
    - reaction of the system ..... 249
  - device..... 237
    - measures ..... 238
    - reaction of the system ..... 238
  - external supply units ..... 249
  - flow measurement ..... 260
    - measures ..... 260, 261
    - reaction of the system ..... 260
  - fresh gas blender ..... 256
  - fresh gas dosing..... 256
  - gas measurement ..... 259
    - reaction of the system ..... 259
  - internal units..... 255
  - mains supply ..... 252
    - measures ..... 253
  - no central gas supply ..... 249
  - pressure measurement ..... 261
    - measures ..... 261
    - reaction of the system ..... 261
  - touchscreen..... 255
    - measures ..... 255
    - reaction of the system ..... 255
  - ventilator..... 258
    - measures ..... 258
    - reaction of the system ..... 258
- Failure
  - Fresh gas blender
    - Measures ..... 256
    - System reaction..... 256
  - gas measurement
    - measures ..... 259
  - monitoring
    - fresh gas blender..... 257
  - Monitoring the fresh gas blender
    - Measures ..... 257
    - System reaction..... 257
- Fans ..... 63, 198
- FiO<sub>2</sub> calibration ..... 132
  - execution ..... 132
  - not passed..... 133
  - passed..... 132
  - start ..... 132
- FiO<sub>2</sub> measurement ..... 63, 83
- FiO<sub>2</sub> meter..... 61
- First installation..... 68
- form of ventilation
  - HLM..... 53
- Form of ventilation .... 22, 149, 151, 157, 174, 197, 251, 258, 260
  - MON ..... 53
- FreqSpont ..... 312
- Fresh gas blender..... 193, 244
  - failure of a carrier gas ..... 193
- Fresh gas shortage..... 198
- Front ..... 29, 55
- Function levels..... 37
- Functional safety..... 282
- Further information ..... 16
- Gas connections ..... 71
- Gas flow plans ..... 292, 293
- Gas measurement . 61, 62, 83, 144, 187, 188, 197, 259, 316
  - only with FiO<sub>2</sub> ..... 188
- Gas supply ..... 111

- Gas supply pressures ..... 194
- General information ..... 96, 99, 101, 122, 133, 140, 175, 200, 233, 262, 274, 279, 285, 287
- Guide mains table additional monitors ..... 34
- Guidelines
  - Manufacturer's Declaration
    - electromagnetic emission ..... 24
  - Manufacturer's declaration
    - electromagnetic immunity ..... 25
- halothane ..... 22
- HIS ..... 12
- HLM ..... 12, 67, 153, 174, 214
- IBW ..... 13
- Icons ..... 39, 42, 46
- IMV ..... 12, 48, 158, 162, 214
- information
  - in Service ..... 109
- inoperability
  - device ..... 237
  - measures ..... 237
  - reaction of the system ..... 237
- inspiration
  - manual ..... 294, 300, 306
  - semi-closed ..... 296, 302, 308
- Instructions for start-up ..... 21
- Intended use ..... 22
- isoflurane ..... 22
- Keypad ..... 47, 48, 54, 70, 77, 120, 138, 204, 207, 255, 280
- Language ..... 109, 116
- Leak ..... 12, 245, 246, 247, 312
- Legend gas flow plans ..... 292
- Liability and guarantee ..... 20
- life
  - bronchial aspiration filter ..... 316
  - fan filter pad ..... 317
  - flow sensors ..... 317
  - insp./exp. valve diaphragms ..... 317
  - PEEP valve diaphragm ..... 317
  - sample line ..... 316
  - water trap ..... 316
- Life
  - soda lime ..... 316
- Lighting ..... 115
  - writing shelf ..... 97
- Limit values ..... 74, 76, 178, 195, 207
- Limited start-up option ..... 120
- List of abbreviations ..... 11
- Lists ..... 319
- Load default settings ..... 143
- Locked ventilation parameters ..... 173
- Login ..... 107, 110, 111, 112, 115
- Loops ..... 191
- Low flow ..... 144
- MAC ..... 12, 189, 312
- Mains connection fuses ..... 78
- maintenance
  - by authorised service technicians ..... 274
  - high pressure regulator ..... 271, 279
- Maintenance
  - Gas measurement (sidestream measurement) ..... 263
- Maintenance: ..... 274
- MAN/SPONT 54, 67, 116, 185, 195, 197, 251, 258, 260
- Manometer ..... 55
- manual operation
  - boot process ..... 149
  - selftest ..... 149
- Manual selection of the narcotic gas ..... 190
- Manual ventilation ..... 151
  - Patient module 0209100 ..... 294
  - Patient module 0209100hul200 ..... 300
  - Patient module 0209100lm300 ..... 306
- manual/spontaneous ventilation
  - start ..... 151
- Manufacturer
  - Messages ..... 19
- Maximum ventilation frequency
  - at applicable
    - I
      - E ratio ..... 173
    - at applicable  $T_{insp}$  ..... 174
- measured values
  - numerical display ..... 184
- Measured values
  - as graphical display ..... 179
- Measuring unit of the measured CO<sub>2</sub> value ..... 111
- mechanical ventilation
  - start ..... 160
- Mechanical ventilation ..... 157
  - Patient module 0209100 ..... 296
  - Patient module 0209100hul200 ..... 302
  - Patient module 0209100lm300 ..... 308
- Minimal flow ..... 144
- Miscellaneous ..... 284
- Modules ..... 47, 235
- Moisture in the ventilation system ..... 144
- MON ..... 12, 67
- MON mode ..... 155
- Monitored data ..... 179
- monitoring
  - calculated values II ..... 187
  - device functions ..... 192
  - lung function ..... 191
- Monitoring ..... 54, 175
  - Calculated values I ..... 184
  - Ventilation measured values ..... 184
- Mounting additional monitors ..... 288
- Mute ..... 54
  - 10 min. .... 54
  - 2 min. .... 54
- Notes ..... 290
- O<sub>2</sub>

- as drive gas ..... 197
- calibration ..... 248
- consumption Pat. .... 112
- emergency dosing
  - during shutdown..... 139
  - during the system test..... 124
- flush ..... 55
- Output ..... 112
- Operating concept ..... 37
- Operating instructions ..... 36
- Operating requirements..... 22
- Operating states of the system test block . 123
- operation
  - device connections ..... 60
  - emergency O<sub>2</sub> dosing ..... 60
- Operation 48, 62, 70, 101, 120, 250, 255, 258, 269
  - 10 L bottles ..... 71
  - keypad ..... 51
  - Reserve gas bottles ..... 71
  - touchscreen ..... 50
- Option panel ..... 62, 84
  - Variant DRYLINE™ watertrap ..... 57
  - Variant LM Watertrap..... 57
- options board
  - external fresh gas outlet version..... 58
  - external O<sub>2</sub> outlet version ..... 58
- Options board ..... 57
- Order
  - Accessories ..... 319
  - Replacement part ..... 319
- Out-of-operation for a longer period..... 70
- Overview..... 29
- Passed system test ..... 128
- Patient categories..... 140
- Patient module ... 31, 64, 79, 83, 90, 140, 151, 153, 243, 265, 266, 267, 280, 293
- Patient monitoring ..... 233
- Patientsafe ..... 237
- PCV ..... 13, 48, 158, 164, 166, 173, 214, 260
- PDMS ..... 13, 289
- PEEP ... 13, 66, 152, 154, 158, 163, 166, 168, 170, 172, 173, 266, 293, 298, 304, 310
- Plateau ..... 13, 152, 154, 158, 162, 163, 166, 168, 170, 172, 299, 305, 311
- Pmax pressure limit in the IMV ..... 162
- Power off ..... 138
- preparation
  - for start-up ..... 71
  - reserve gas bottles ..... 270
- Preparation..... 68
- pressure
  - central gas supply ..... 195
- Pressure
  - Central gas supply ..... 195
- pressure display
  - supply from 10 L bottles..... 196
- Pressure display
  - intact central gas supply ..... 195
  - No central gas supply..... 195
- Pressure flow characteristics ..... 314
- Pressure relief valve ..... 234
- Product combinations ..... 287
- Production and dosage of the vacuum ..... 56
- PSV..... 13, 158, 159, 171, 174
- quick start
  - execute..... 150
- Quick start..... 38, 121, 126, 149, 150
- Railing system ..... 32
- Real-time and trend curves ..... 102
- Rear ..... 30
- Rear wall..... 63, 83
- Removing the patient module ..... 64
- Repeating individual system test blocks... 129
- Replace
  - Calibrate ..... 276
- Replacement part ..... 286
- Requirements at the application site ..... 69
- Residual hazards ..... 18
- Resistance ..... 13, 313
- Results of the selftest ..... 124
- Retention of documentation..... 16
- Rotary switch ..... 47, 48, 50, 51, 255
- Safety..... 269, 284, 287
- Safety concept..... 47
- Safety for you and the patient..... 17
- Saving alarm messages ..... 202
- Saving the current system configuration .. 110
- Screen
  - brightness..... 97
  - Brightness ..... 97
- Screensaver..... 54
- Selection
  - mechanical form of ventilation ..... 157
- Self check ..... 120, 214
- Selftest..... 37, 118, 119, 124
- Service..... 106
  - Information ..... 106
- Service life
  - FiO<sub>2</sub> cell ..... 316
  - Inspection glass ..... 318
  - O<sub>2</sub> cell ..... 316
  - Replacement part..... 316
  - Reusable CO<sub>2</sub> absorber ..... 317
- Service settings ..... 109
- servicing
  - 10 L bottles..... 269
  - by hospital staff ..... 262
  - fans ..... 268
  - flow sensors ..... 265
  - PEEP valve diaphragm ..... 266
  - side power measurement..... 277
- Servicing
  - insp./exp. valve diaphragms ..... 267
  - reserve gas bottles..... 269
- Servicing interval ..... 275

- setting
  - anaesthetic vaporiser ..... 148
  - dependent on patient category ..... 116
  - dependent on the patient category ..... 117
  - fresh gas ..... 145
  - ventilation parameters ..... 70
- Setting
  - Alarm limits ..... 134
  - Ventilation parameters ..... 158
- Setting patient alarm limits manually ..... 207
- Setting up the anaesthetic vaporiser ..... 90
- settings
  - general ..... 116
- sevoflurane ..... 22
- short check
  - before start-up ..... 119
- Short check
  - before start-up ..... 94, 119
  - Before start-up ..... 319
  - CGS ..... 72, 75, 76
  - DGAI ..... 95
  - Reserve gas bottles ..... 73
- Short instructions ..... 319
- Short operating instructions ..... 319
- Sidestream measurement ..... 62, 84, 316
- S-IMV ..... 13, 158, 167
- Software
  - Version ..... 106
- S-PCV ..... 14, 158, 159, 169
- Start-up ..... 94
  - 10 L gas cylinders ..... 71
  - Reserve gas cylinders ..... 71
- STC ..... 281
- Stopwatch ..... 199
- Storage compartment ..... 33
- Support arms ..... 32, 289
- Suspension bracket of the intake system ... 89
- Switch on ..... 37, 143
- Symbols ..... 43, 44, 102, 179, 181, 191
- system configuration
  - saving ..... 116
  - user interface ..... 101
- System information ..... 109
- system test
  - cancel ..... 126
  - detailed error display ..... 128
  - execution ..... 126
  - not passed ..... 128
  - procedure ..... 131
  - skip ..... 126
  - start ..... 125
- System test .. 38, 94, 119, 120, 122, 124, 125, 126, 127, 129, 132, 265
  - Execution ..... 121
- System test blocks ..... 38, 122
- tab
  - option ..... 100, 101
  - service ..... 108
  - system time ..... 99
- Tab
  - Config ..... 96, 100
  - volume ..... 98, 101
- Tab system ..... 52
- Tabular trend ..... 46, 182
- Takeover of ventilation parameters ..... 174
- Technical data ..... 320
- Technical safety controls ..... 279
- tightness
  - full system ..... 130
  - tube system ..... 130
- Time ..... 99
- Title bar ..... 52, 54, 199, 204, 252
- To change a form of ventilation ..... 161
- To switch to standby (stop ventilation) ..... 161
- Touch screen ..... 50, 138
- Touchscreen ..... 47, 49, 280
- troubleshooting
  - high-pressure regulator ..... 271
  - reserve gas cylinders ..... 271
- Tube and cable guides ..... 34
- Tube and cable openings ..... 34
- Tube holder ..... 34
- Turn off ..... 101, 183, 235
- Turn on ..... 118, 120
- User interface ..... 47, 235
- User manual
  - compliance ..... 17
  - Structure and purpose ..... 16
- Vacuum ..... 55
- Validity of this instruction manual ..... 15
- Ventilation ..... 140
- ventilation parameters
  - weight entry ..... 141
- Ventilation parameters .48, 50, 105, 152, 154, 157, 161, 163, 166, 168, 170, 172, 173, 183
- Ventilator ..... 31
- Volume ..... 98, 116
- Volume guarantee VTG in the PCV ..... 165
- VSF ..... 22
- Warnings ..... 17
- Weight (IBW) ..... 141
- window
  - three loops ..... 191
- Window
  - Gas measurement ..... 188
- Writing shelf ..... 33

### Short checklist before start-up for leon plus

Test			Description		Passed	
					Yes	No
1.	Visual monitoring	Technical monitoring of damage, completely correct set-up, hygienic cleanliness, suitable accessories, test seal				
<b>Turn off device</b>						
2.	Plug in CGS, plug in mains cable					
3.	Mains supply	available (green LED mains connection control lit)				
4.	O <sub>2</sub> emergency dosing	O <sub>2</sub> emergency dosing at 15 l/min, audible inflow sound in the ventilation bag. O <sub>2</sub> emergency dosing at 0 l/min				
<b>Turn on device</b>						
5.	Potential equalisation*	connected (to device and to wall connection)				
6.	CO <sub>2</sub> absorber	Sieve with seal correctly placed, protective cap available, filled, filling date, lime not coloured, locked				
7.	Breathing bellows in dome	Available and correctly adjusted				
8.	Dome	adjusted, finger-tight, tight				
9.	Patient module	Attachment parts completely and firmly adjusted, blue insp./exp. Valve diaphragm on carriers available, correctly inserted, docking station with patient module correctly locked onto the device				
10.	APL	available, at 20 mbar. Checked rapid venting*				
11.	Patient tube system	Ventilation tubes on Ø 22 mm cones on the front of the patient module (Caution: do not short-circuit), ventilation bag on Ø 22 mm cone on the underside of the patient module, Y-piece available and plugged into test adapter, respiratory system filter new				
12.	AGS, AGSS	Correctly connected (with adapter on Ø 30 mm cone to the underside of the patient module), aspiration performance monitored				
13.	Gas measurement (O <sub>2</sub> , CO <sub>2</sub> *, N <sub>2</sub> O*, NG*)	available (internally or externally), connected, (patient adapter*, measuring gas tube*, water trap*), ready for operation, check water trap for fill state and expiry date*				
14.	Anaesthetic vaporiser*	Correct fit, fill state, at 0, connected to electricity*				
<b>15. Execute system test</b>						
16.	O <sub>2</sub> control	Unplug the patient adapter* of the gas measurement with y-piece from the test adapter, start MAN/SPONT, set a fresh gas flow of 100% O <sub>2</sub> and 5 l/min. The O <sub>2</sub> measured value must rise recognisably. Re-plug the patient adapter* with y-piece into the test adapter.				
17.	O <sub>2</sub> flush	Activate O <sub>2</sub> flush button, audible inflow sound in the ventilation bag, key resets				
18.	Ext. O <sub>2</sub> outlet*	Ext. O <sub>2</sub> flow meter at 15 l/min, gas flows audibly from the ext. O <sub>2</sub> outlet. Ext. O <sub>2</sub> flow meter at 0 l/min				
19.	Fresh gas outlet*	External fresh gas outlet switch at 1 (ON), activate O <sub>2</sub> flush key, gas flows audibly from the fresh gas outlet. External gas outlet switch at 0 (OFF)				
20.	Bronchial aspiration	connected, filter available, ready for operation -> VAC display ≤(-0.7) bar with locked aspiration tube				
21.	Battery charged	Unplug mains cable. Remaining runtime display = 60 min. = 100min from SW vers. ≥ 3.11.x				
22.	Reserve gas bottles*	Check tightness, connections and fill state				
23.	Visual alarm signal, audible	Trigger an alarm, LED lit on keypad, alarm signal can be heard				
24.	Auxiliary devices*	Secured, check in accordance with their own user manuals				
25.	Independent ventilation equipment e.g. ventilation bag with mask available, checked					
26.	Test alarms (also on auxiliary devices*)					
27.	Conduct PaF test when patient changes or tubing is replaced					















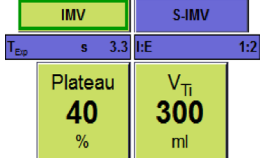

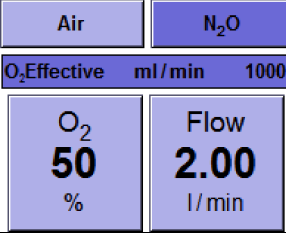

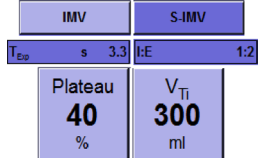

\*If available

\_\_\_\_\_  
Name of checker

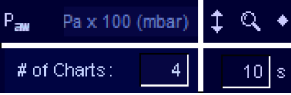
\_\_\_\_\_  
Signature

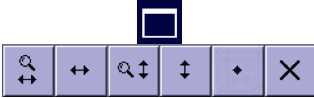
\_\_\_\_\_  
Date of testing

**leon plus Short operating instructions**

Keypad		Touch screen	
	leon plus ON + OFF		Display mains operation / battery operation
	Standby (stop ventilation)		Select patient category
	Start of a form of ventilation		Preset form of ventilation and parameters
	Selection fresh gas blender		Setting fresh gas blender
	Selection of form of ventilation and parameters		Setting of running form of ventilation and parameters
	Opening and closing alarm limits window		Adjust alarm limits automatically
	Selection of MAN/SPONT form of ventilation		Selection of MAN/SPONT form of ventilation
	Selection of real-time graphs		Real-time graphs control elements
	Opening and closing alarm limits window		Control elements loops
	Switch between windows		Switch between windows
	Muting of alarm tone for 2 or 10 minutes		Mute display 2 or 10 minutes

**Checklist of technical safety controls**

Technical safety controls carried out in accordance with DIN EN 62353 by:

\_\_\_\_\_  
Company / Department

\_\_\_\_\_  
Name of checker

\_\_\_\_\_  
Name of device (serial name / inventory number)

<b>Mechanical safety</b>	<b>Passed</b>	
	<b>Yes</b>	<b>No</b>
Gas connection tubes		
Keypad		
Touchscreen		
Patient module		
Bag-in-bottle unit		
CO <sub>2</sub> absorber		
Anaesthetic vaporiser		
PC and other monitor support arms		
Tube support arm		
Cable support arm		
Workstation illumination		
Trolley		

<b>Electrical safety</b>	<b>Passed</b>	
	<b>Yes</b>	<b>No</b>
Electric cables (state)		
	Measured value:	
Protective cable resistance	max. 0.2 Ohm	Ohm
Reserve device earth leakage	max. 1.0 mA	mA
Insulation resistance	>2 MOhm	MOhm

Functional safety		Passed	
		Yes	No
Check for tightness			
Alarms LEDs keyboard, audible			
PEEP valve			
Ventilation pressure			
Fresh gas blender	Flow		
	Gas concentrations		
Anaesthetic vaporiser			
Gas measurement			
O <sub>2</sub>	Ratio system		
	N <sub>2</sub> O cut-off		
	Flush		
Reserve	Switch-over		
	Return flow		
APL			
Batteries			

Miscellaneous		Passed	
		Yes	No
Visual check of external changes			
Visual check of external faults or damage			
Check device combinations			
Labels complete and legible			
User manual must be present and correspond to the installed software version.			
Warnings in the German language must be present.			
Alarm and safety functions in accordance with the user manual			
Medical product book must be present			

Test device	Type	Serial number	Calibrated up to



Result of check	Remarks on check
No technical safety faults	
Faults were immediately fixed	
Faults that require servicing	
Fixable faults; this device may only be used after faults have been fixed. Danger for patients, users or third parties.	

---

**Name of checker**

---

**Signature**

---

**Check date**

# LÖWENSTEIN medical

Löwenstein Medical SE & Co. KG  
Arzbacher Straße 80  
56130 Bad Ems/Germany



: +49 2603/9600-0



: +49 2603/9600-50



: [loewensteinmedical.com](http://loewensteinmedical.com)

Checklist of technical safety controls for *leon plus*

---



Subject to change

As at 03.11.2022

# LÖWENSTEIN medical

**Löwenstein Medical SE & Co. KG**

Arzbacher Straße 80  
56130 Bad Ems/Germany



: +49 2603/9600-0



: +49 2603/9600-50



: [loewensteinmedical.com](http://loewensteinmedical.com)

User manual *leon plus*

Order no.: Ba-0301v311

CE 0197

---